



ROLAN

Instruments GmbH

Chirurgie • Surgery • Chirurgie • Cirugía



ROLAN

Chirurgie • Surgery • Chirurgie • Cirugía

Ausgabe / Edition / Edition / Edición 09-2003

© 2016 ROLAN Instruments GmbH / Printed in Germany

Wir behalten uns vor, Änderungen und Verbesserungen durchzuführen und die Instrumente und Geräte ohne besonderen Hinweis in der modifizierten Ausführung auszuliefern.

Die Verwendung dieses Kataloges zu anderen Zwecken als ausschließlich der zum Vertrieb von ROLAN-Produkten ist untersagt. Zuwiderhandlungen werden rechtlich geahndet. Der Nachdruck, auch auszugsweise, ist verboten.

We reserve the right of technical modifications and improvements and to supply the instruments and apparatus without specific indication in the modified finish.

The use of this catalogue is restricted to actions necessary for selling original ROLAN products. The use for any purpose other than selling original ROLAN products is prohibited and will be prosecuted. Reprinting, even partially, is not allowed.

Nous nous réservons le droit d'effectuer des modifications et des améliorations et de livrer les instruments et appareils dans leur version modifiée sans mention spéciale.

L'utilisation de ce catalogue à d'autres fins que les seules opérations nécessaires à la vente des produits ROLAN est interdite. Toute infraction fera l'objet d'une poursuite en justice. La reproduction, même partielle, est interdite.

Nos reservamos el derecho de realizar modificaciones y mejoras y de entregar los instrumentos y los aparatos, sin avisar específicamente que se ha modificado la versión correspondiente.

Se prohíbe el uso de este catálogo para otras finalidades que las acciones exclusivamente necesarias para comercializar los productos de ROLAN. Se perseguirá jurídicamente a los infractores.

Queda prohibida la reimpresión, incluso de partes del catálogo.

ROLAN
Instruments GmbH

Ernst-Thälmann-Str. 50
D-15859 Storkow / Mark
Germany

Telefon: +49 33678 / 44 94 33

e-mail: info@rolan-instruments.de
internet: www.rolan-instruments.de

Inhaltsübersicht
Table of Contents
Table de matières
Tabla del contenido

01	Diagnostik	1 - 8
	Diagnostics	1 - 8
	Diagnostics	1 - 8
	Diagnóstico	1 - 8
02	Anästhesie, Absaugung, Laryngoskope	9 - 14
	Anaesthesia, Aspiration, Laryngoscopes	9 - 14
	Anesthésie, aspiration, laryngoscopes	9 - 14
	Anestesia, aspiración, laringoscopios	9 - 14
03	Skalpellklingen, Skalpellgriffe, OP-Messer, Allgemeine Chirurgie	15 - 22
	Scalpelblades, Scalpelhandles, Operating Knives, Comon Surgery	15 - 22
	Bistouris, manches de bistouris, couteaux, chirurgie générale	15 - 22
	Hojas y mangos de bisturí, cuchillos, cirugía general	15 - 22
04	Chirurgische Scheren	23 - 50
	Surgical Scissors	23 - 50
	Ciseaux à chirurgie	23 - 50
	Tijeras para cirugía	23 - 05
05	Ophthalmologie und Mikroschere	51 - 54
	Ophthalmology and Micro Scissors	51 - 54
	Ciseaux oculaires, micro-ciseaux	51 - 54
	Micro-tijeras, tijeras para oftalmología	51 - 54
06	Pinzetten	55 - 66
	Dressing and Tissue Forceps	55 - 56
	Pinces à dissection	55 - 66
	Pinzas de disección	55 - 66
07	Arterienklemmen	67 - 96
	Haemostatic Forceps	67 - 96
	Pinces hémostatiques	67 - 96
	Pinzas hemostáticas	67 - 96
08	Tuchklemmen, Korn- und Tupferzangen	97 - 104
	Towel Clamps, Swab and Cotton Forceps	97 - 104
	Pinces serre-tubes, pinces à champs, pinces à pansements et à polypes	97 - 104
	Pinzas para tubos, pinzas de campo, pinzas para pólipos y esponjas	97 - 104
09	Wundhaken, Wundsperrer	105 - 138
	Wound Retractors	105 - 138
	Ecarteurs	105 - 138
	Separadores	105 - 138
10	Sonden, Spatel, Watteträger	139 - 144
	Sounds, Spatula, Cotton Applicators	139 - 144
	Porte-coton, sondes, stylets	139 - 144
	Sondas, espátulas, porta-algodón	139 - 144
11	Trokare	145 - 150
	Trocars	145 - 150
	Trocarts	145 - 150
	Trócares	145 - 150
12	Nadelhalter	151 - 164
	Needle Holders	151 - 164
	Porte-aiguilles	151 - 164
	Porta-agujas	151 - 164

Inhaltsübersicht
Table of Contents
Table de matières
Tabla del contenido

13	Nahtinstrumente und Nähnadeln, Nahtbesteck, Sterilisationsinstrumente165 - 178 Suturing Instruments and Needles, Suturing Sets, Sterilizing Instruments165 - 178 Instruments et aiguilles à suture, instruments pour stérilisation165 - 178 Agujas e instrumentos de sutura, instrumentos para esterilización165 - 178
14	Gipsverband, Elektrische Gipssäge179 - 182 Plaster of Paris, Electric Plaster Cast Cutter179 - 182 Appareil plâtres, scie électric179 - 182 Vendajes enyesados, sierra eléctrica para yesos179 - 182
15	Hohlmeißelzangen, Knochensplitter- und -halte­zangen, Knochenchirurgie183 - 222 Bone Rongeurs, Bone Cutting Forceps, Bone Holding Forceps, Bone Surgery183 - 222 Pincers gouges, pincers coupantes à os, davi­ers porte-os, chirurgie osseuse183 - 222 Pinzas-gubias, pinzas cortantes para huesos, cirugía ósea183 - 222
16	Amputation, Handbohrer, Osteosynthese223 - 242 Amputation, Bone Drills, Oste­synthesis223 - 242 Amputation, perforateurs à main, ostéosyn­thèse223 - 242 Amputación, perforadores a mano, osteosín­tesis223 - 242
17	Marknagelung, Knochenchirurgie243 - 266 Bone Nailing, Bone Surgery243 - 266 Enclouage des os, chirurgie osseuse243 - 266 Enclavamiento de huesos, cirugía ósea243 - 266
18	Neurochirurgie, Laminektomie, Gefäßchirurgie267 - 282 Neurosurgery, Laminectomy, Vascular Surgery267 - 282 Neurochirurgie, laminectomie, chirurgie vasculaire267 - 282 Neurocirugía, laminectomía, cirugía vascular267 - 282
19	Ophthalmologie283 - 316 Ophthalmology283 - 316 Ophthalmologie283 - 316 Oftalmología283 - 316
20	Otologie317 - 338 Otology317 - 338 Otologie317 - 338 Otología317 - 338
21	Rhinologie339 - 362 Rhinology339 - 362 Rhinologie339 - 362 Rinología339 - 362
22	Mund und Zunge363 - 370 Mouth and Tongue363 - 370 Bouche et langue363 - 370 Boca y lengua363 - 370
23	Tonsillen371 - 376 Tonsilectomy371 - 376 Amygdales371 - 376 Amígdalas371 - 376
24	Kehlkopf377 - 380 Larynx377 - 380 Larynx377 - 380 Laringe377 - 380

Inhaltsübersicht
Table of Contents
Table de matières
Sumario

25	Gastroskopie	381 - 384
	Gastroscopy	381 - 384
	Gastroscopie	381 - 384
	Gastroscopía	381 - 384
26	Tracheotomie, Kropf	385 - 388
	Tracheostomy, Goitre	385 - 388
	Trachéostomie, goitre	385 - 388
	Traqueotomía, bocio	385 - 388
27	Thorax, Rippenscheren, Rippenspreizer, Lungeninstrumente	389 - 400
	Thorax, Rib Shears, Rib Spreader, Lung Instruments	389 - 400
	Thorax, costotomes, ecarteur des côtes, poumon	389 - 400
	Tórax, costótomos, separadores costales, pulmón	389 - 400
28	Galle, Niere	401 - 406
	Gall, Kidney	401 - 406
	Voies biliaires, rein	401 - 406
	Vesícula biliar, riñón	401 - 406
29	Magen, Darm	407 - 418
	Intestines, Stomach	407 - 418
	Intestin, estomac	407 - 418
	Intestinos, estómago	407 - 418
30	Urologie	419 - 426
	Urology	419 - 426
	Urologie	419 - 426
	Urología	419 - 426
31	Rektum	427 - 432
	Rectum	427 - 432
	Rectum	427 - 432
	Recto	427 - 432
32	Gynäkologie	433 - 462
	Gynecology	433 - 462
	Gynécologie	433 - 462
	Ginecología	433 - 462
33	Geburtshilfe	463 - 470
	Obstetrics	463 - 470
	Obstétrique	463 - 470
	Obstetricia	463 - 470
34	Dermatologie	471 - 474
	Dermatology	471 - 474
	Dermatologie	471 - 474
	Dermatología	471 - 474
35	Sterilisierbehälter, Instrumentenschalen, Lösungsschalen, Nadeldosen	475 - 480
	Trays, Instrument Cases, Solution Bowls, Needle Cases	475 - 480
	Boîtes et plateaux à instruments, tambours à stérilisation, Boîtes à aiguilles	475 - 480
	Tambores para esterilización, bandejas, cajas para agujas	475 - 480
	Inhaltsverzeichnis, Nummernverzeichnis	481 - 542
	Index, Index of Numbers	481 - 542
	Index, Index des numéros de références	481 - 542
	Indice alfabético, Índice de números de referencias	481 - 542

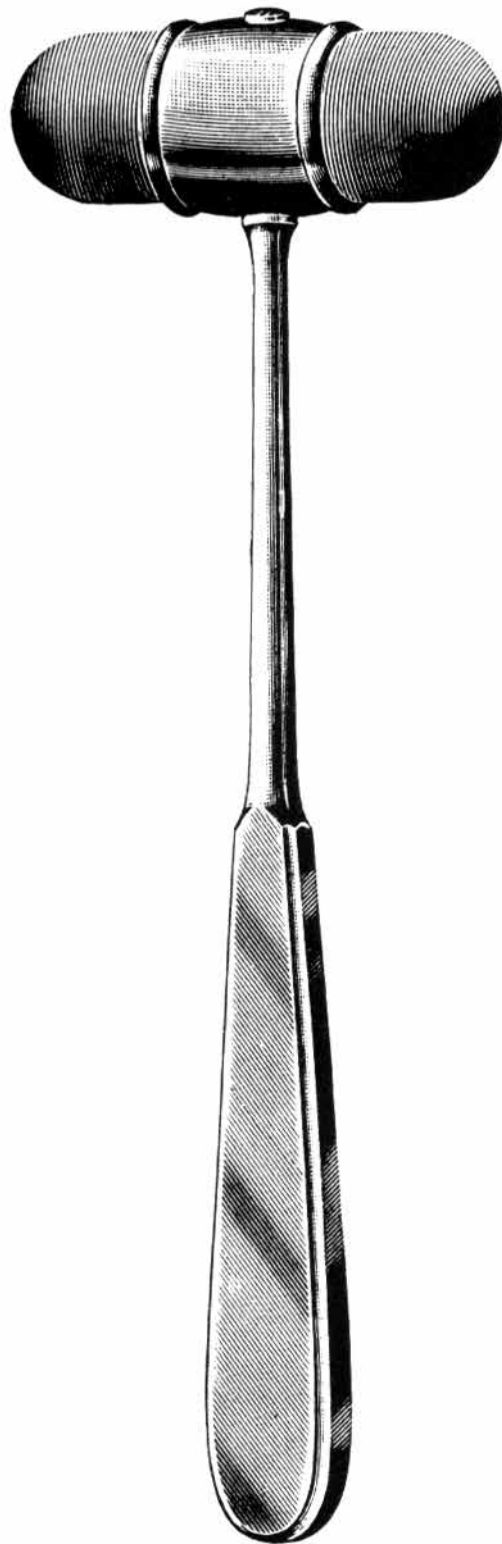



01-1010.00



01-1109.00



01-1110.00



01-1111.00

01



COLLIN

01-1112.01

für Kinder
for children
pour enfants
para niños

01-1112.02

für Erwachsene
for adults
pour adultes
para adultos



FRANCKE

01-1113.00



01-1114.00



01-1200.00



01-1210.00



UNIVERSAL

01-1220.00

Stirnspiegel und Stirnlampen
Head Mirrors, Head Lights
Lampes frontales
Espejos y lámparas frontales



ZIEGLER
01-1300.90

Ø 90 mm



01-1300.91
 Ø 90 mm



01-1300.92



CLAR
01-1310.00



CLAR
01-1312.00



01-1310.01



01-1312.01



01-1312.06

01



PINARD
01-1405.00

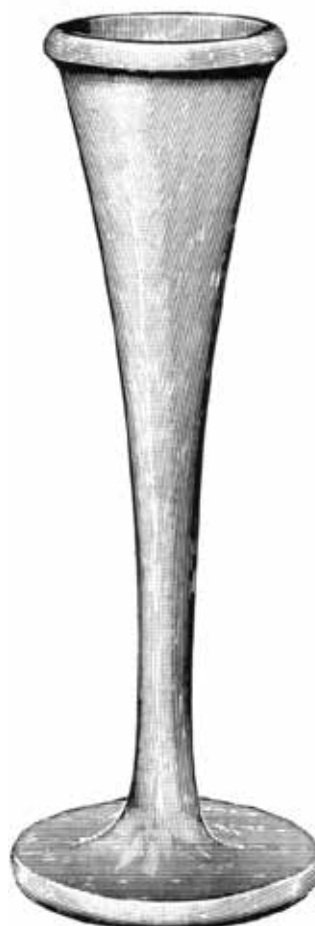

WINTER
01-1406.00

Perkussionshämmer
Percussion Hammers
Marteaux-percuteurs
Martillos de percusión



TAYLOR

01-1500.17 17 cm, 6 3/4"

01-1500.20 20 cm, 8"



TRAUBE

01-1504.16

16 cm, 6 1/4"



BABINSKY

01-1510.22

22 cm, 8 1/2"



TROEMNER

01-1511.24

24 cm, 9 1/2"



DEJERINE

01-1513.20

20 cm, 8"



DEJERINE

01-1514.20

20 cm, 8"



BERLINER

01-1515.17

17 cm, 6 3/4"

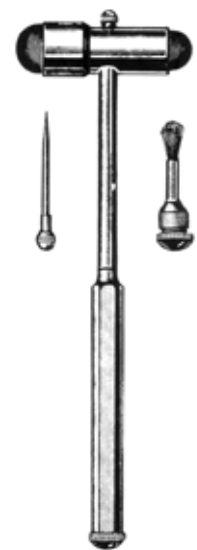

BUCK

01-1517.18

18 cm, 7"

01



BERTILLON
01-1610.01



MOELTGEN
01-1615.01



WARTENBERG
01-1620.19
 19 cm, 7 1/2"



01-1625.10 10 cm, 4"

01-1625.20 20 cm, 8"

01-1625.30 30 cm, 12"

01-1625.50 50 cm, 20"



01-1627.15
 1,5 m

Anästhesie, Absaugung, Laryngoskopie
Anesthesia, Aspiration, Laryngoscopes
Anesthésie, Aspiration, Laryngoscopes
Anestesia, Aspiración, Laringoscopios



02



POOLE

02-1002.10

Ø 10 mm, 30 Fr.



POOLE

02-1004.08

Ø 8 mm, 23 Fr.



YANKAUER

02-1005.27

27 cm, 10 1/2"



MAGILL



02-1010.17

17 cm, 6 3/4"



02-1010.20

20 cm, 8"



02-1010.25

25 cm, 10"



MC INTOSH

02-2011.00	Fig. 1 - 4
02-2013.00	Fig. 2 - 4

MC INTOSH cold light

02-2021.00	Fig. 1 - 4
02-2023.00	Fig. 2 - 4



cold light	
02-2045.00	02-2041.00
Fig. 0	Fig. 0



cold light	
02-2045.01	02-2041.01
Fig. 1	Fig. 1



cold light	
02-2045.02	02-2041.02
Fig. 2	Fig. 2



cold light	
02-2045.03	02-2041.03
Fig. 3	Fig. 3



cold light	
02-2045.04	02-2041.04
Fig. 4	Fig. 4



FOREGGER

02-2032.00 Fig. 1 - 4

02-2030.00 Fig. 2 - 4



02-2046.00

Fig. 1



02-2046.01

Fig. 2



02-2046.03

Fig. 3



02-2046.04

Fig. 4



02-2050.28 28 mm

02-2050.37 37 mm



02-2051.01

Fig. 1



02-2051.02

Fig. 2 - 4



02-2055.02

cold light



02-2056.00

cold light

Anästhesie, Absaugung, Laryngoskopie
Anesthesia, Aspiration, Laryngoscopes
Anesthésie, Aspiration, Laryngoscopes
Anestesia, Aspiración, Laringoscopios

02

Skalpelli- und Klagen, OP-Messer, allgemeine Chirurgie
Scalpelhandles, -blades, Knives
Manches de bistouris, lames
Mangos de bisturias, hojas



03

Skalpellegriffe- und Klingen, OP-Messer, allgemeine Chirurgie
 Scalpelhandles, -blades, Knives
 Manches de bistouris, lames
 Mangos de bisturias, hojas

03



03-0100.03
No. 3



03-0100.13
No. 3L



03-0102.04
No. 4



03-0102.14
No. 4L



03-0103.07
No. 7



03-0103.17
No. 7K



03-0104.08
No. 8

Skalpellgriffe- und Klingen, OP-Messer, allgemeine Chirurgie
 Scalpellhandles, -blades, Knives
 Manches de bistouris, lames
 Mangos de bisturios, hojas

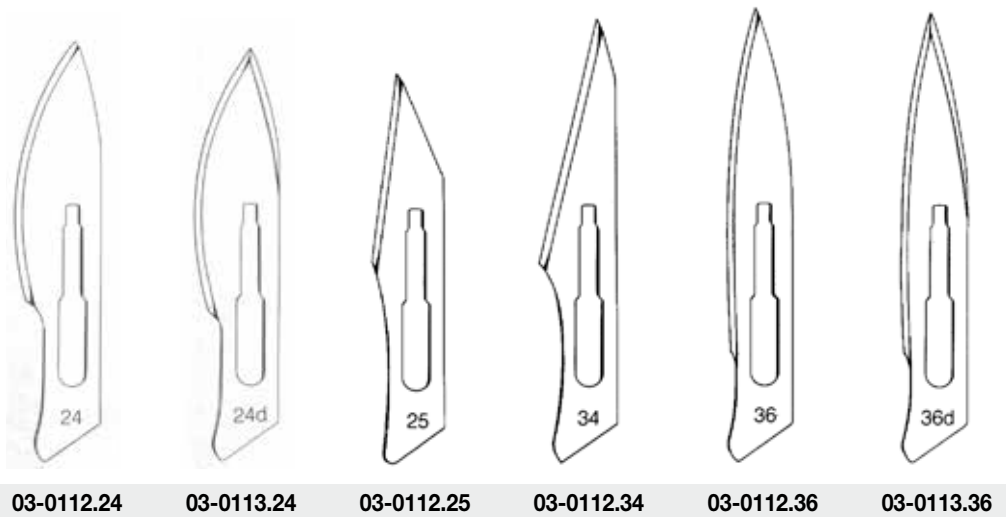
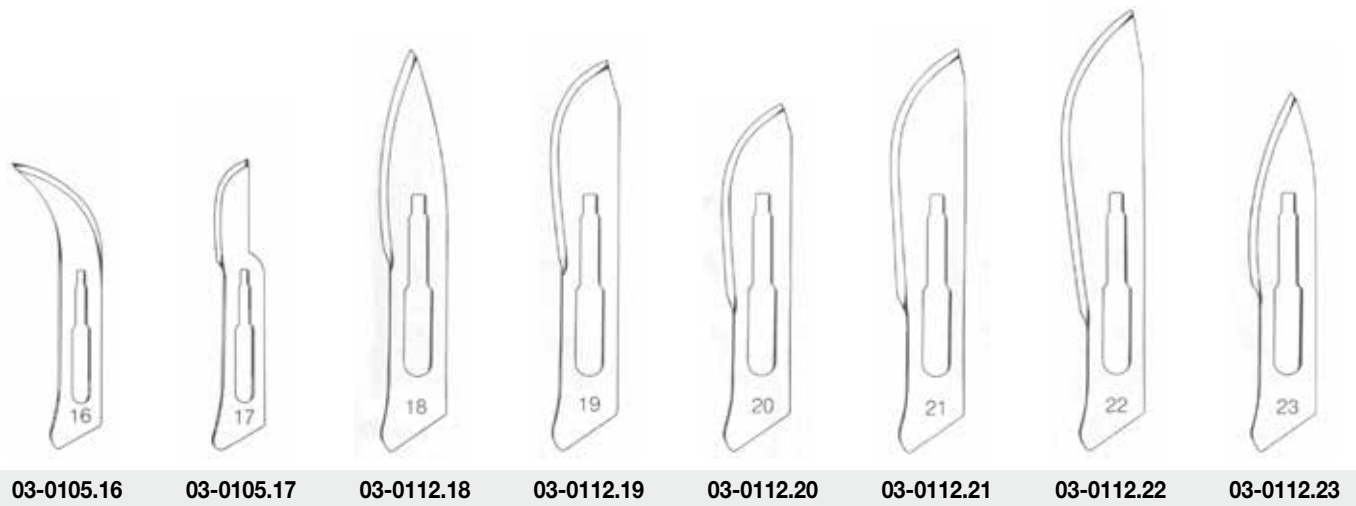



TROUTMAN

03-0120.09

9 cm, 3 1/2"



TROUTMAN

03-0121.09

9 cm, 3 1/2"



Ø 8 mm

CASTROVIEJO

03-0124.13

13 cm, 5"

OP-Skalpelle mit Metallheft
Scalpels with Metal Handle
Bistouris, manche metal
Bisturías con mango metálico



03-0220.01 03-0220.02 03-0220.03 03-0220.04 03-0220.05



03-0220.06 03-0220.07 03-0220.08 03-0220.09 03-0220.10



OP-Skalpelle mit Metallheft
Scalpels with Metal Handle
Bistouris, manche metal
Bisturías con mango metálico

03

Amputationsmesser
 Amputating Knives
 Couteaux à amputation
 Cuchillos para amputación



PARKER
03-0224.01

Fig. 1



PARKER
03-0224.02

Fig. 2



03-0318.13 13 cm, 5"

03-0318.16 16 cm, 6 1/4"

03-0318.19 19 cm, 7 1/2"

03-0318.22 22 cm, 8 3/4"

03-0318.28 28 cm, 11"



LISTON
03-0320.17 17 cm, 6 3/4"

03-0320.20 20 cm, 8"



Resektionsmesser
 Resection Knives
 Couteaux à résection
 Cuchillos para resección

LANGENBECK

03-0306.05



LANGENBECK

03-0308.05



Knorpelmesser
 Cartilage Knife
 Couteaux à cartilage
 Cuchillo para cartílagos

VIRCHOW

03-0510.25

25 cm, 10"



Messer
 Knives
 cerveau
 cerebro

03-0590.16 16 cm, 6 1/4"

03-0590.20 20 cm, 8"

03-0590.24 24 cm, 9 1/2"



SCHINK
03-0420.00



03-0420.01

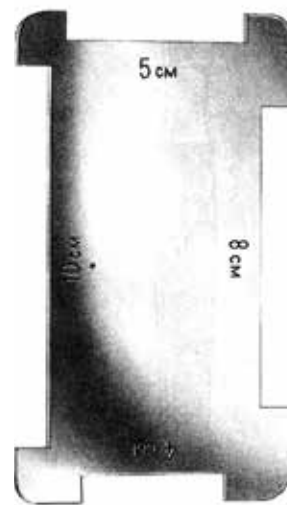

03-0420.02

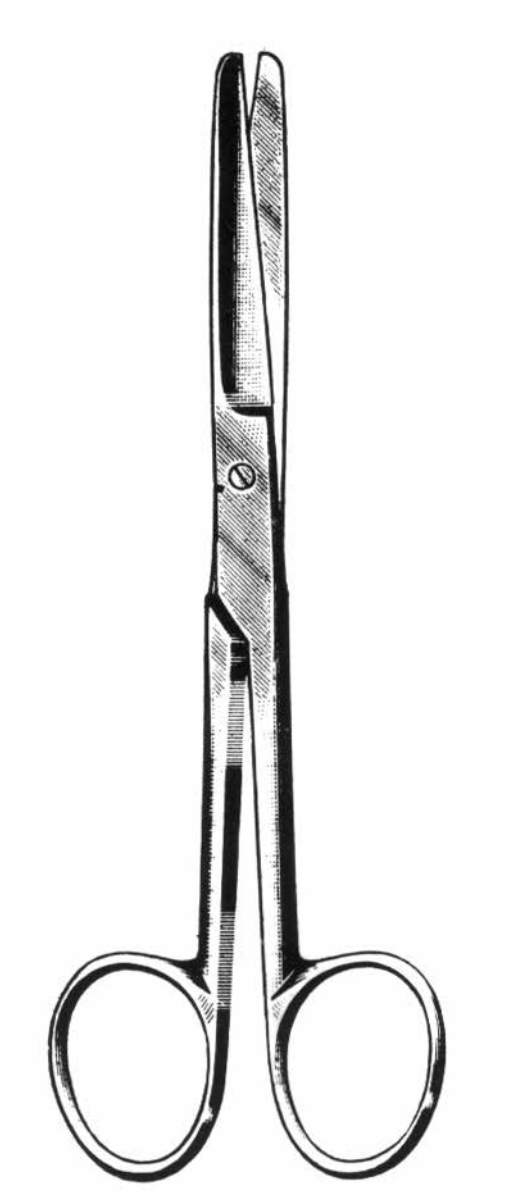

Chirurgische Scheren
Operating Scissors
Ciseaux à chirurgie
Tijeras para cirugía

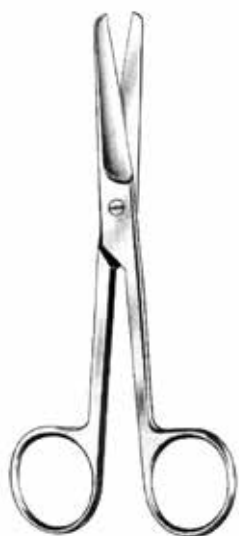

04-1120.10	10,5 cm, 4"
04-1120.11	11 cm, 4 1/4"
04-1120.13	13 cm, 5"
04-1120.14	14,5 cm, 5 1/2"
04-1120.15	15,5 cm, 6"
04-1120.16	16,5 cm, 6 1/2"
04-1120.18	18 cm, 7"
04-1120.20	20 cm, 8"



04-1130.10	10,5 cm, 4"
04-1130.11	11 cm, 4 1/4"
04-1130.13	13 cm, 5"
04-1130.14	14,5 cm, 5 1/2"
04-1130.15	15,5 cm, 6"
04-1130.16	16,5 cm, 6 1/2"
04-1130.18	18 cm, 7"
04-1130.20	20 cm, 8"



04-1140.10	10,5 cm, 4"
04-1140.11	11 cm, 4 1/4"
04-1140.13	13 cm, 5"
04-1140.14	14,5 cm, 5 1/2"
04-1140.15	15,5 cm, 6"
04-1140.16	16,5 cm, 6 1/2"
04-1140.18	18 cm, 7"
04-1140.20	20 cm, 8"



04-1121.10	10,5 cm, 4"
04-1121.11	11 cm, 4 1/4"
04-1121.13	13 cm, 5"
04-1121.14	14,5 cm, 5 1/2"
04-1121.15	15,5 cm, 6"
04-1121.16	16,5 cm, 6 1/2"
04-1121.18	18 cm, 7"
04-1121.20	20 cm, 8"

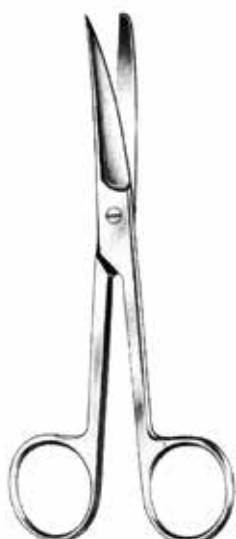

04-1131.10	10,5 cm, 4"
04-1131.11	11 cm, 4 1/4"
04-1131.13	13 cm, 5"
04-1131.14	14,5 cm, 5 1/2"
04-1131.15	15,5 cm, 6"
04-1131.16	16,5 cm, 6 1/2"
04-1131.18	18 cm, 7"
04-1131.20	20 cm, 8"



04-1141.10	10,5 cm, 4"
04-1141.11	11 cm, 4 1/4"
04-1141.13	13 cm, 5"
04-1141.14	14,5 cm, 5 1/2"
04-1141.15	15,5 cm, 6"
04-1141.16	16,5 cm, 6 1/2"

04

Chirurgische Scheren
Operating Scissors
Ciseaux à chirurgie
Tijeras para cirugía



DEAVER



04-1224.14
14 cm, 5 1/2"



04-1225.14
14 cm, 5 1/2"



DEAVER



04-1242.14
14 cm, 5 1/2"



04-1243.14
14 cm, 5 1/2"



DEAVER



04-1256.14
14 cm, 5 1/2"



04-1257.14
14 cm, 5 1/2"



04-1220.14
14 cm, 5 1/2"

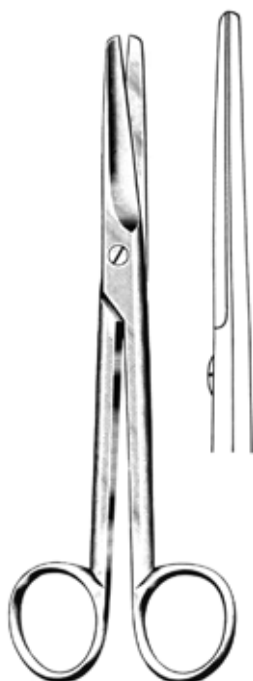

MAYO

04-1260.14 14,5 cm, 5 1/2"

04-1260.17 17 cm, 6 3/4"

04-1260.23 23 cm, 9"



MAYO

04-1261.14 14,5 cm, 5 1/2"

04-1261.17 17 cm, 6 3/4"

04-1261.23 23 cm, 9"

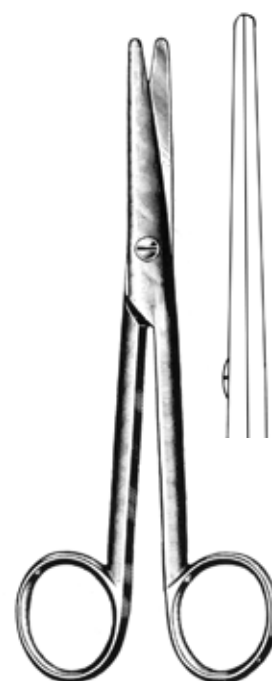

MAYO-STILLE

04-1270.15 15 cm, 5 3/4"

04-1270.17 17 cm, 6 3/4"

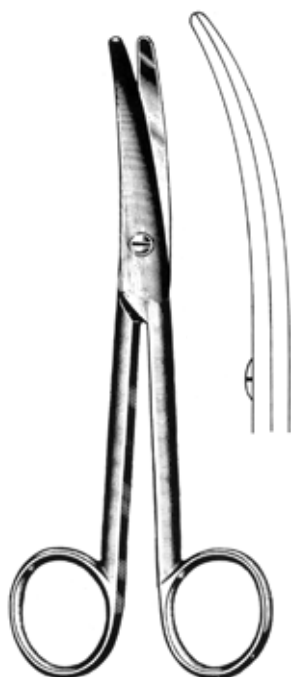

MAYO-STILLE

04-1271.15 15 cm, 5 3/4"

04-1271.17 17 cm, 6 3/4"

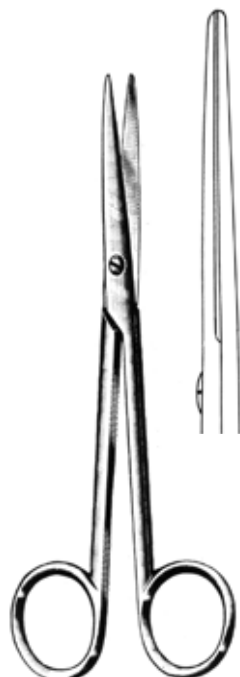

LEXER

04-1300.16 16 cm, 6 1/4"

04-1300.21 21 cm, 8 1/4"

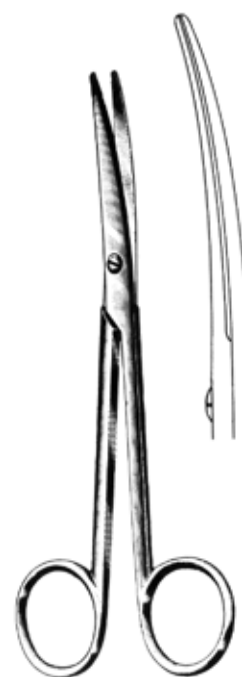

LEXER

04-1301.16 16 cm, 6 1/4"

04-1301.21 21 cm, 8 1/4"

Chirurgische Scheren
Operating Scissors
Ciseaux à chirurgie
Tijeras para cirugía



LEXER-BABY



04-1310.10

10 cm, 4"



04-1311.10

10 cm, 4"



MAYO-NOBLE



04-1280.17

17 cm, 6 3/4"



04-1281.17

17 cm, 6 3/4"

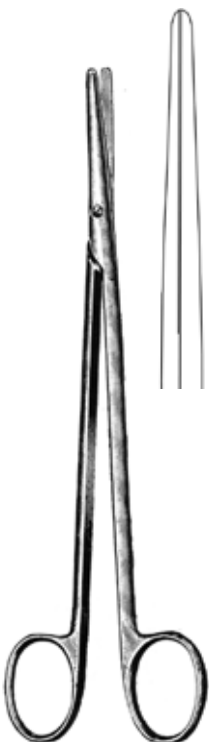

METZENBAUM

04-1320.11 10,5 cm, 4"

04-1320.15 15 cm, 5 3/4"

04-1320.18 18 cm, 7"

04-1320.20 20 cm, 8"

04-1320.23 23 cm, 9"

04-1320.25 25 cm, 10"

04-1320.28 28 cm, 11"

04-1320.30 30 cm, 12"



METZENBAUM

04-1321.11 10,5 cm, 4"

04-1321.15 15 cm, 5 3/4"

04-1321.18 18 cm, 7"

04-1321.20 20 cm, 8"

04-1321.23 23 cm, 9"

04-1321.25 25 cm, 10"

04-1321.28 28 cm, 11"

04-1321.30 30 cm, 12"

04



04-1332.15 15 cm, 5 3/4"

04-1332.18 18 cm, 7"

04-1332.20 20 cm, 8"

04-1332.23 23 cm, 9"

METZENBAUM-FINO



04-1331.15 15 cm, 5 3/4"

04-1331.18 18 cm, 7"

04-1331.20 20 cm, 8"

04-1331.23 23 cm, 9"

METZENBAUM-FINO



METZENBAUM

04-1339.12

12 cm, 5"



METZENBAUM-S

04-1341.18

18 cm, 7"



SANVENERO

04-1350.14

14 cm, 5 1/2"

04-1351.14

14 cm, 5 1/2"

Chirurgische Scheren
Operating Scissors
Ciseaux à chirurgie
Tijeras para cirugía



04-1352.14
 14 cm, 5 1/2"

JOSEPH



04-1353.14
 14 cm, 5 1/2"



04-1370.15
 15 cm, 5 3/4"

REYNOLDS



04-1371.15
 15 cm, 5 3/4"

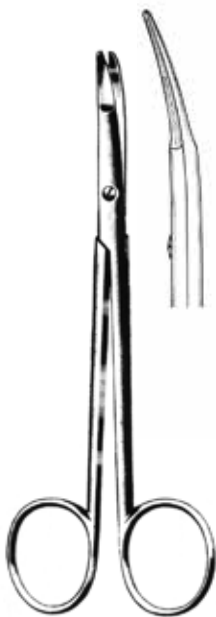

KILNER

04-1360.12 12 cm, 4 3/4"

04-1360.15 15 cm, 5 3/4"



04-1380.09 9 cm, 3 1/2"

04-1380.11 11 cm, 4 1/2"

Irisscheren
 Iris Scissors
 Ciseaux à iris
 Tijeras para iris



04-1381.09 9 cm, 3 1/2"

04-1381.11 11 cm, 4 1/2"

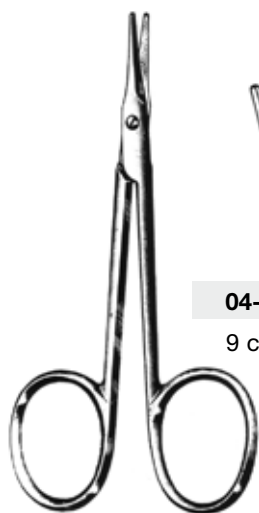

AEBLI

04-1391.09

9 cm, 3 1/2"



04-1393.09

9 cm, 3 1/2"

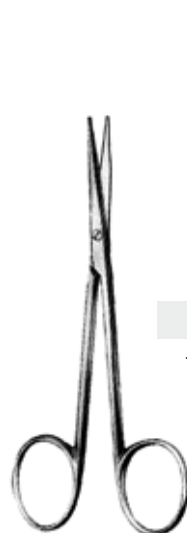

04-1400.11

11 cm, 4 1/4"



04-1401.11

11 cm, 4 1/4"



Strabismusscheren
 Strabismus Scissors
 Ciseaux à strabisme
 Tijeras para estrabismo



STEVENS

04-1394.11

11 cm, 4 1/4"



04-1395.11

11 cm, 4 1/4"



Sehnenscheren
 Tenotomy Scissors
 Ciseaux à ténotomie
 Tijeras para tenotomía



STEVENS

04-1396.11

11 cm, 4 1/4"



04-1397.11

11 cm, 4 1/4"



Sehnenscheren
 Tenotomy Scissors
 Ciseaux à ténotomie
 Tijeras para tenotomía

Tonsillenscheren, Nasenscheren
Tonsil Scissors, Nasal Scissors
Ciseaux pour les amygdales, Ciseaux nasaux
Tijeras para amígdalas, Tijeras nasales



04-1406.11
11 cm, 4 1/2"



04-1407.11
11 cm, 4 1/2"



HEYMANN
04-1408.18
18 cm, 7"



FOMON
04-1410.15
15 cm, 5 3/4"



COTTLE
04-1415.16
16 cm, 6 1/4"



DEAN
04-1435.17
17 cm, 6 3/4"



Gezahnt
Toothed
Dentelée
Dentada

DEAN
04-1437.17
17 cm, 6 3/4"

Tonsillenscheren, Nasenscheren
Tonsil Scissors, Nasal Scissors
Ciseaux pour les amygdales, Ciseaux nasaux
Tijeras para amígdalas, Tijeras nasales

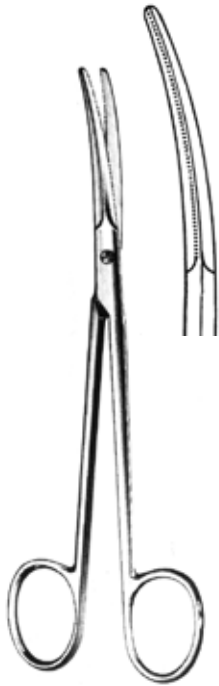

BEUSE

04-1431.14

14 cm, 5 1/2"



BOETTCHER

04-1445.18

18 cm, 7"

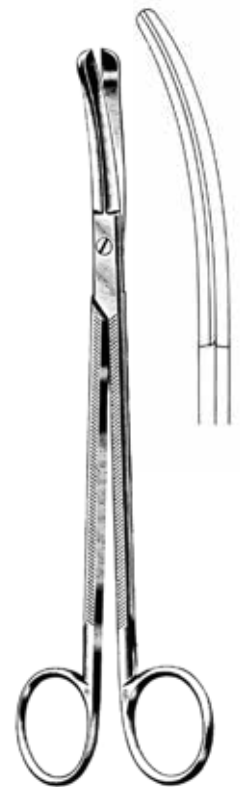

GOOD

04-1447.19

19 cm, 7 1/2"

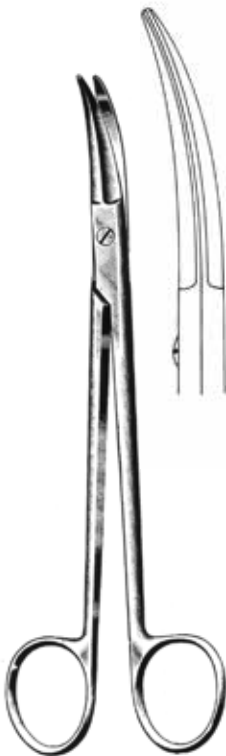

PRINCE

04-1449.17

17 cm, 6 3/4"

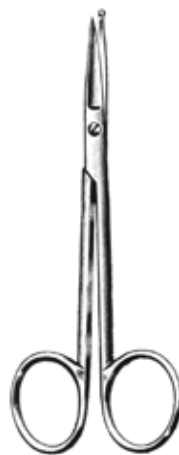

04-1480.11

11 cm, 4 3/4"

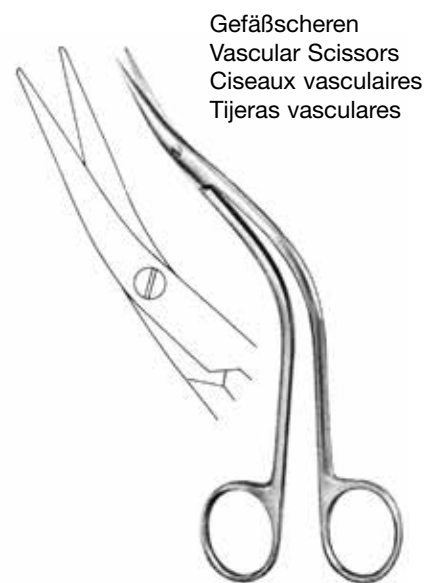

Gefäßscheren
 Vascular Scissors
 Ciseaux vasculaires
 Tijeras vasculares

DE BAKELY

04-1505.15 spitz / sharp

04-1507.15 stumpf / blunt

15,5 cm, 6"

Gefäßscheren
Vascular Scissors
Ciseaux vasculaires
Tijeras vasculares

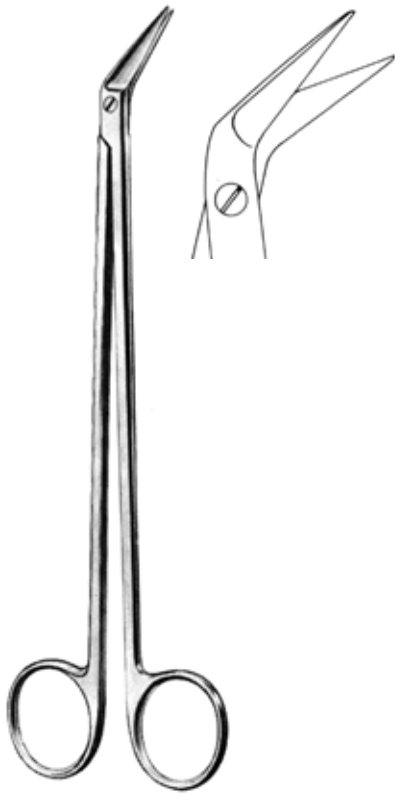

POTTS-DE MARTEL

04-1483.21 21 cm, 8 1/4"

04-1483.24 24 cm, 9 1/2"



POTTS-SMITH

19 cm, 7 1/2"

04-1490.25

25°

04-1490.40

40°

04-1490.60

60°

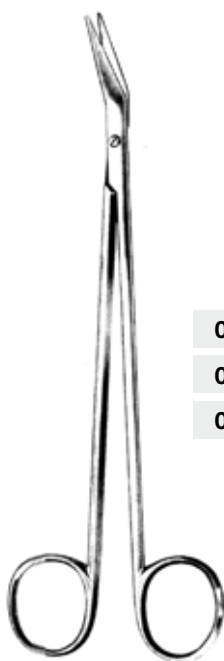

DE BAKEY



04-1501.16 16 cm, 6 1/4"

04-1501.23 23 cm, 9"

04-1501.28 28 cm, 11"

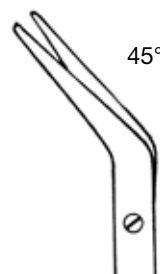

04-1502.16 16 cm, 6 1/4"

04-1502.23 23 cm, 9"

04-1502.28 28 cm, 11"

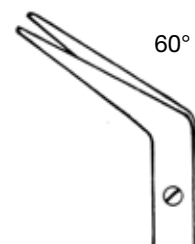

04-1503.16 16 cm, 6 1/4"

04-1503.23 23 cm, 9"

04-1503.28 28 cm, 11"

Gynäkologische Scheren
Gynaecological Scissors
Ciseaux gynécologiques
Tijeras ginecológicas

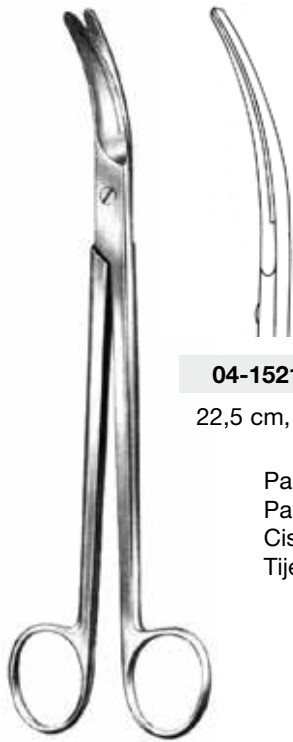

04-1521.22

22,5 cm, 8 3/4"



04-1523.22

22,5 cm, 8 3/4"

Parametriumscheren
Parametrium Scissors
Ciseaux à parametrium
Tijeras para parametrio

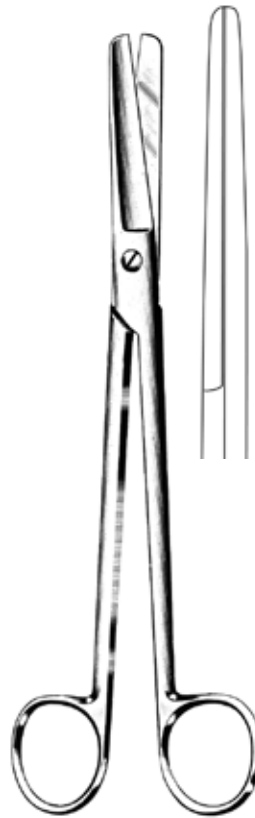

SIMS

04-1530.20 20 cm, 8"

04-1530.23 23 cm, 9"

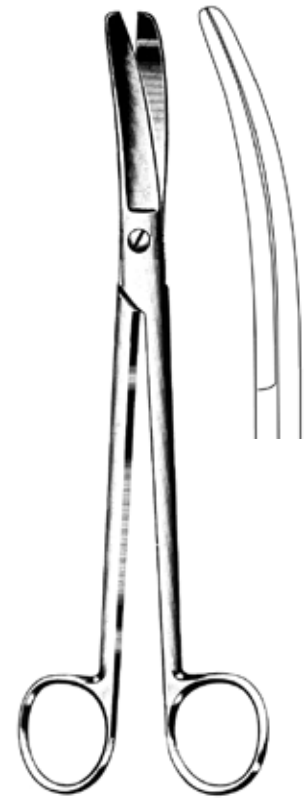

SIMS

04-1531.20 20 cm, 8"

04-1531.23 23 cm, 9"

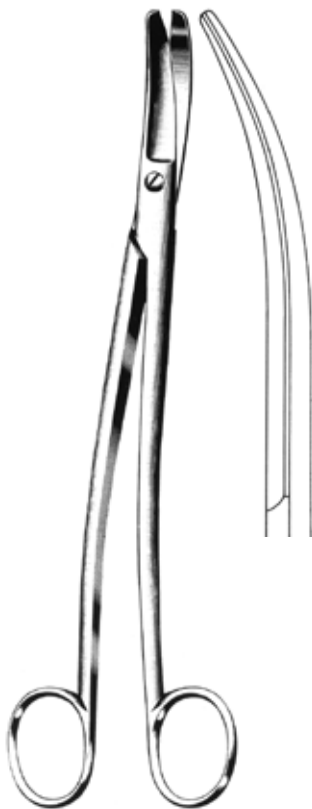

SIEBOLD

04-1543.24

24 cm, 9 1/2"

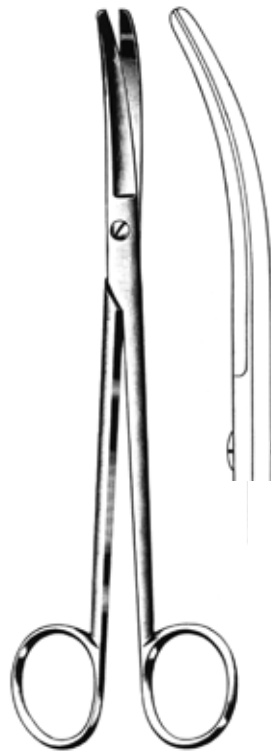

WERTHEIM

04-1545.22

22,5 cm, 8 3/4"



DOYEN

04-1550.17

17,5 cm, 7"



04-1551.17

17,5 cm, 7"

Gynäkologische Scheren
Gynaecological Scissors
Ciseaux gynécologiques
Tijeras ginecológicas



DUBOIS



04-1556.27
 27 cm, 10 1/2"



04-1557.27
 27 cm, 10 1/2"

Nabelschnurscheren
 Umbilical Cord Scissors
 Ciseaux pour le cordon ombilical
 Tijeras para el cordón umbilical

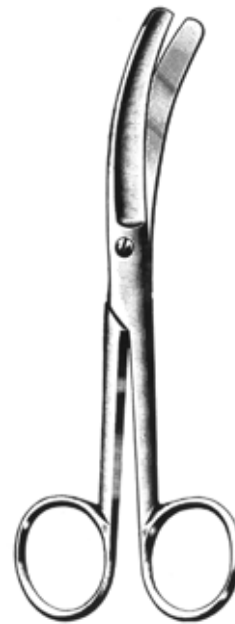

BUSCH

04-1571.16
 16 cm, 6 1/4"



SCHUMACHER

04-1573.15
 15 cm, 5 3/4"

Nabelschnurscheren
 Umbilical Cord Scissors
 Ciseaux pour le cordon ombilical
 Tijeras para el cordón umbilical



USA MODELL

04-1570.10
 10,5 cm, 4"



BRAUN-STADLER

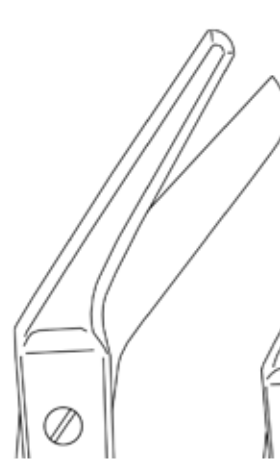

04-1580.14
 14,5 cm, 5 1/2"



04-1580.22
 22 cm, 8 1/2"

Episiotomiescheren
 Episiotomy Scissors
 Ciseaux à épisiotomie
 Tijeras para episiotomía

Chirurgische Scheren, Präparierscheren
Operating Scissors, Dissecting Scissors
Ciseaux à chirurgie, Ciseaux à dissection
Tijeras para cirugía, Tijeras de disección

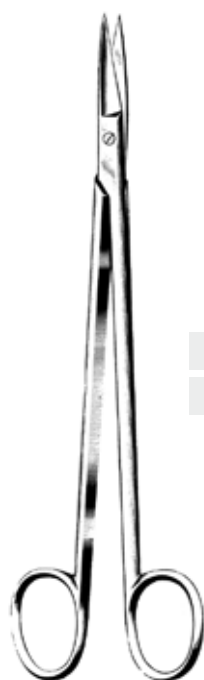

KELLY



04-1560.16 16 cm, 6 1/4"

04-1560.18 18 cm, 7"



04-1561.16 16 cm, 6 1/4"

04-1561.18 18 cm, 7"

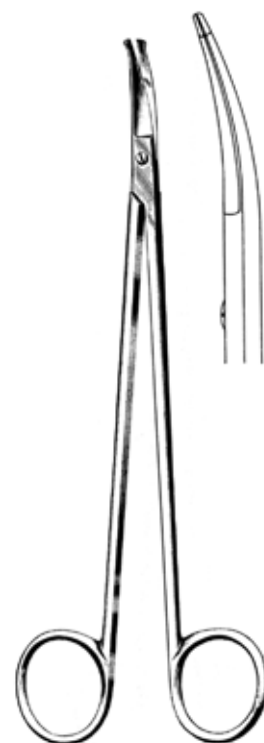

STRULLY

04-1601.22

22 cm, 8 1/2"



04-1590.11

11 cm, 4 1/4"



04-1591.11

11 cm, 4 1/4"



04-1592.15

15 cm, 5 3/4"



04-1593.15

15 cm, 5 3/4"

Präparierscheren
Dissecting Scissors
Ciseaux à dissection
Tijeras de disección

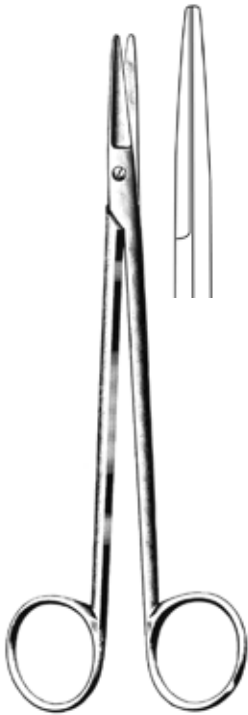

TOENNIS-ADSON

04-1610.18

18 cm, 7"



TOENNIS-ADSON

04-1611.18

18 cm, 7"

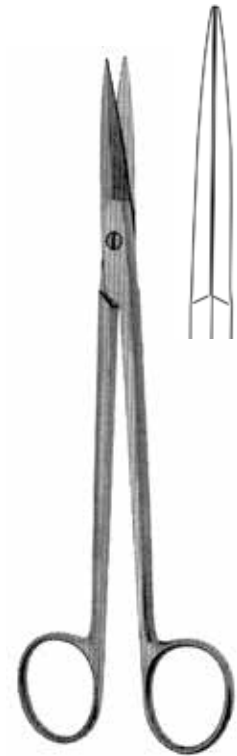

MC INDOE

04-1614.19

19 cm, 7 1/2"



DANDY

04-1617.17

17 cm, 6 3/4"



SCHMIEDEN-TAYLOR

04-1619.17

17 cm, 6 3/4"

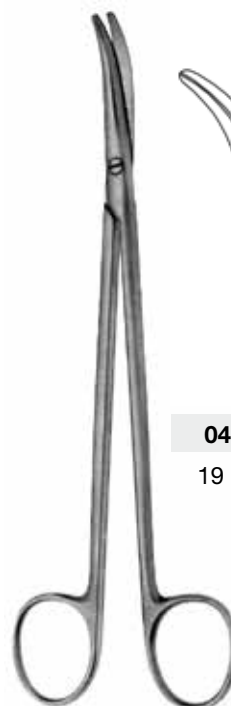

THOREK

04-1623.19

19 cm, 7 1/2"



04-1623.25

25 cm, 10"

Präparierscheren, Thoraxscheren
Dissecting Scissors, Thorax Scissors
Ciseaux à dissection, Ciseaux thoraciques
Tijeras de disección, Tijeras torácicas

04

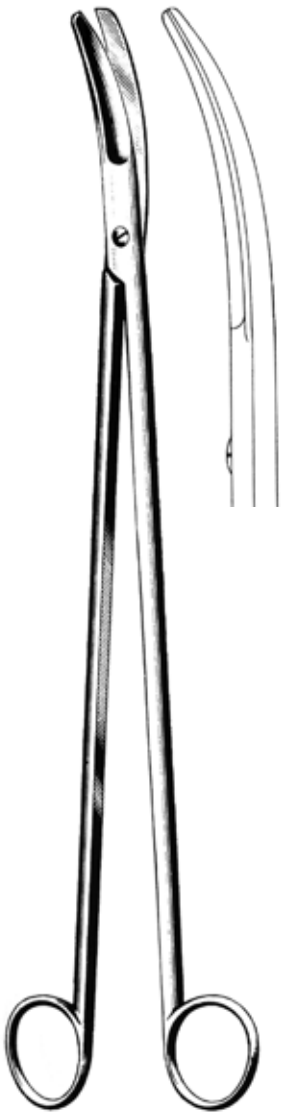

CRAFOORD

04-1621.30

30 cm, 12"

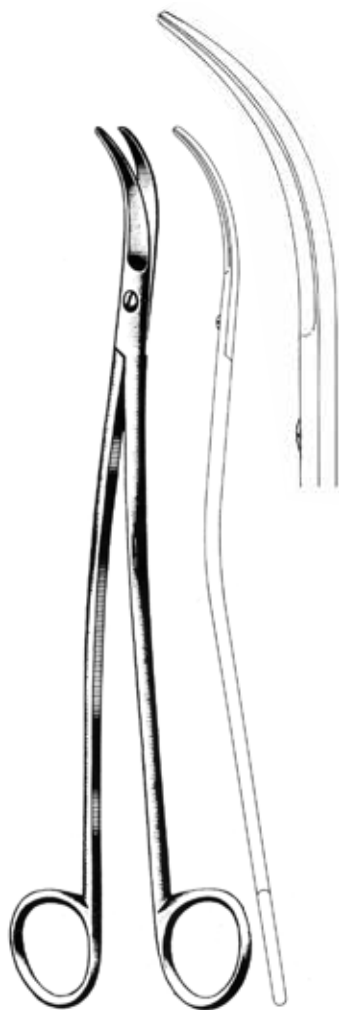

SATINSKY

04-1631.24

24,5 cm, 9 3/4"



KLINKENBERGH-LOTH

04-1641.23

23 cm, 9"

Darmscheren, Ligaturscheren
Enterotomy Scissors, Ligature Scissors
Ciseaux entérotomes, Ciseaux à ligatures
Tijeras enterótomos, Tijeras para ligaduras



04-1650.21

21 cm, 8 1/4"



04-1652.21

21 cm, 8 1/4"



04-1654.21

21 cm, 8 1/4"



SPENCER

04-1660.09

9 cm, 3 1/2"



SPENCER

04-1662.11

11 cm, 4 1/4"



NORTHBENT

04-1663.13

13 cm, 5"



LITTAUER

04-1664.14

14 cm, 5 1/2"

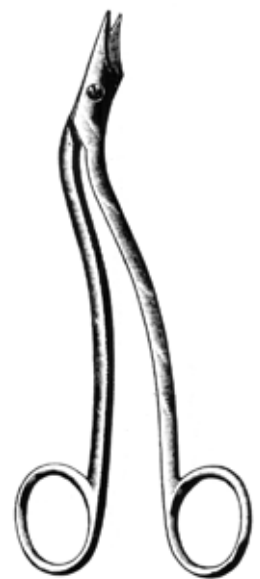

HEATH

04-1669.15

15 cm, 5 3/4"

Zahnfleischscheren
Gum Scissors
Ciseaux pour gencive
Tijeras para encías



04-1670.13
13 cm, 5"



04-1671.13
13 cm, 5"



WAGNER



04-1674.12
12 cm, 4 3/4"



04-1675.12
12 cm, 4 3/4"



QUINBY

04-1677.12

12 cm, 4 3/4"

Drahtscheren, Verbandscheren
Wire Cutting Scissors, Bandage Scissors
Ciseaux coupe-fils, Ciseaux à pansements
Tijeras corta-alambres, Tijeras para vendajes



UNIVERSAL

04-1731.12

12 cm, 4 3/4"



BEEBEE



04-1740.10

10 cm, 4"



04-1741.10

10 cm, 4



04-1742.10

10 cm, 4



04-1743.10

10 cm, 4



SMITH

04-1748.15 15 cm, 5 3/4"

04-1748.16 16 cm, 6 1/4"

04-1748.18 18 cm, 7"

04-1748.20 20 cm, 8"



LISTER

04-1751.11 11 cm, 4 1/4"

04-1751.14 14 cm, 5 1/2"

04-1751.18 18 cm, 7"

04-1751.20 20 cm, 8"



BERGMANN

04-1761.23

23 cm, 9"

Verbandscheren
Bandage Scissors
Ciseaux à pansements
Tijeras para vendajes



ESMARCH

04-1763.20 20 cm, 8"

04-1763.22 22 cm, 8 1/2"



BRUNS

04-1775.23

23 cm, 9"



BRUNS

04-1777.23

23 cm, 9"



KNOWLES

04-1770.14

14 cm, 5 1/2"



LORENZ

04-1773.23

23 cm, 9"



WALTON

04-1780.20

20 cm, 8"



UNIVERSAL

04-1782.15 15 cm, 5 3/4"

04-1782.18 18 cm, 7"

04

Scheren mit Hartmetallschneiden
Scissors with Tungsten Carbide Edges
Ciseaux avec des lames en tungstène
Tijeras con filos de carburo de tungsteno



04-1122.14 14,5 cm, 5 1/2"

04-1122.16 16,5 cm, 6 1/2"



04-1132.14 14,5 cm, 5 1/2"

04-1132.16 16,5 cm, 6 1/2"



04-1142.14 14,5 cm, 5 1/2"

04-1142.16 16,5 cm, 6 1/2"



04-1123.14 14,5 cm, 5 1/2"

04-1123.16 16,5 cm, 6 1/2"



04-1133.14 14,5 cm, 5 1/2"

04-1133.16 16,5 cm, 6 1/2"



04-1143.14 14,5 cm, 5 1/2"

04-1143.16 16,5 cm, 6 1/2"

Scheren mit Hartmetallschneiden
 Scissors with Tungsten Carbide Edges
 Ciseaux avec des lames en tungstène
 Tijeras con filos de carburo de tungsteno



04-1234.14
 14 cm, 5 1/2"



04-1235.14
 14 cm, 5 1/2"

DEAVER



04-1252.14
 14 cm, 5 1/2"



04-1253.14
 14 cm, 5 1/2"

DEAVER

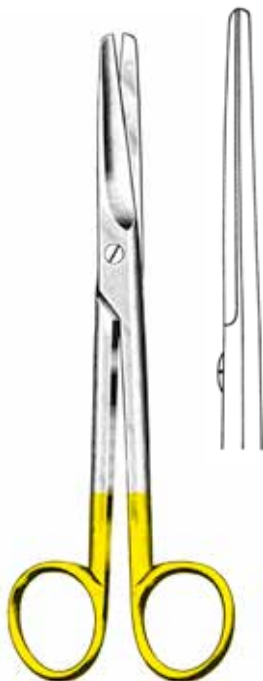

MAYO

04-1264.14 14,5 cm, 5 1/2"

04-1264.17 17 cm, 6 3/4"

04-1264.23 23 cm, 9"



MAYO

04-1265.14 14,5 cm, 5 1/2"

04-1265.17 17 cm, 6 3/4"

04-1265.23 23 cm, 9"

Scheren mit Hartmetallschneiden
Scissors with Tungsten Carbide Edges
Ciseaux avec des lames en tungstène
Tijeras con filos de carburo de tungsteno

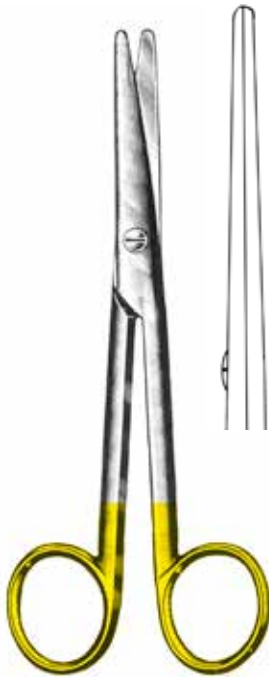

MAYO-STILLE

04-1274.15 15 cm, 5 3/4"

04-1274.17 17 cm, 6 3/4"

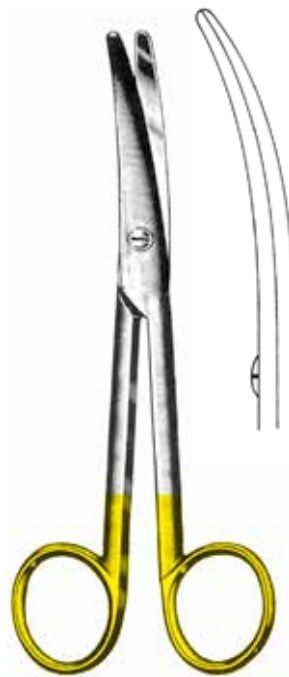

MAYO-STILLE

04-1275.15 15 cm, 5 3/4"

04-1275.17 17 cm, 6 3/4"

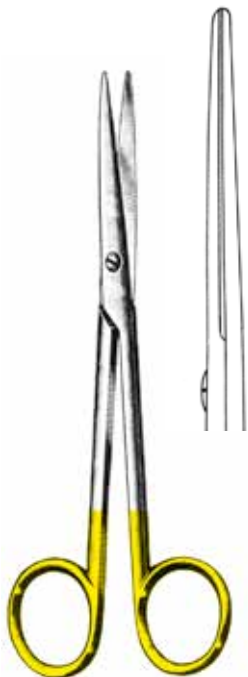

LEXER

04-1304.16 16 cm, 6 1/4"

04-1304.21 21 cm, 8 1/4"



LEXER

04-1305.16 16 cm, 6 1/4"

04-1305.21 21 cm, 8 1/4"

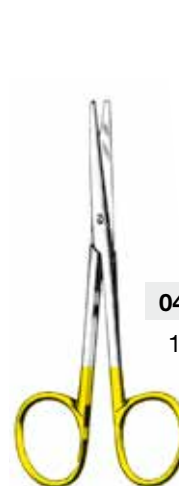

04-1314.10

10 cm, 4"



04-1315.10

10 cm, 4"

Scheren mit Hartmetallschneiden
Scissors with Tungsten Carbide Edges
Ciseaux avec des lames en tungstène
Tijeras con filos de carburo de tungsteno

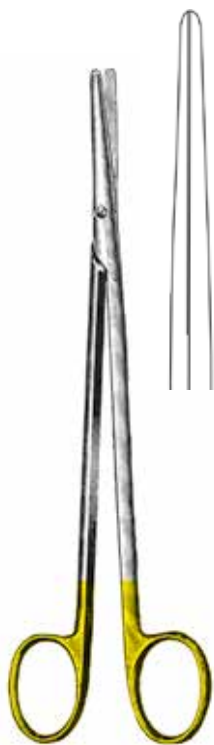

04-1324.11	10,5 cm, 4"
04-1324.15	15 cm, 5 3/4"
04-1324.18	18 cm, 7"
04-1324.20	20 cm, 8"
04-1324.23	23 cm, 9"
04-1324.25	25 cm, 10"
04-1324.28	28 cm, 11"
04-1324.30	30 cm, 12"

METZENBAUM



04-1325.11	10,5 cm, 4"
04-1325.15	15 cm, 5 3/4"
04-1325.18	18 cm, 7"
04-1325.20	20 cm, 8"
04-1325.23	23 cm, 9"
04-1325.25	25 cm, 10"
04-1325.28	28 cm, 11"
04-1321.30	30 cm, 12"

METZENBAUM



04-1336.15	15 cm, 5 3/4"
04-1336.18	18 cm, 7"
04-1336.20	20 cm, 8"
04-1336.23	23 cm, 9"
04-1336.25	25 cm, 10"
04-1336.28	28 cm, 11"

METZENBAUM-FINO

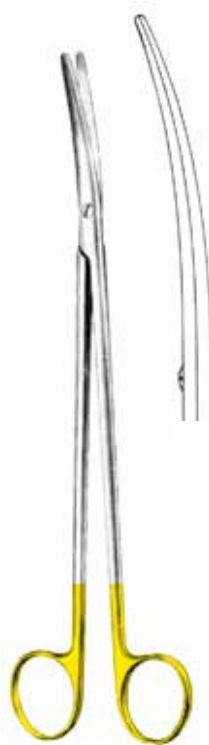

04-1337.15	15 cm, 5 3/4"
04-1337.18	18 cm, 7"
04-1337.20	20 cm, 8"
04-1337.23	23 cm, 9"
04-1337.25	25 cm, 10"
04-1337.28	28 cm, 11"

METZENBAUM-FINO

Scheren mit Hartmetallschneiden
Scissors with Tungsten Carbide Edges
Ciseaux avec des lames en tungstène
Tijeras con filos de carburo de tungsteno



METZENBAUM-S

04-1345.18

18 cm, 7"

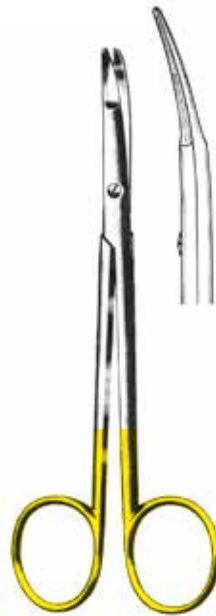

KILNER

04-1364.12 12 cm, 4 3/4"

04-1364.15 15 cm, 5 3/4"

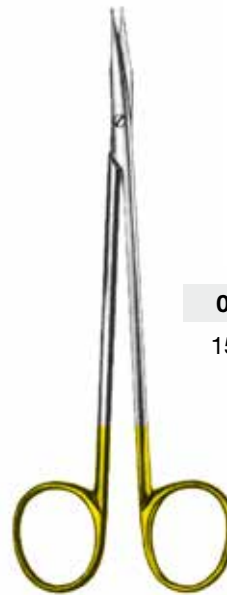

REYNOLDS

04-1374.15

15 cm, 5 3/4"



04-1375.15

15 cm, 5 3/4"

04



Irisscheren
 Iris Scissors
 Ciseaux à iris
 Tijeras para iris

04-1384.11

11 cm, 4 1/4"



04-1385.11

11 cm, 4 1/4"



04-1404.11

11 cm, 4 1/4"



04-1405.11

11 cm, 4 1/4"

Strabismusscheren
 Strabismus Scissors
 Ciseaux à strabisme
 Tijeras para estrabismo

Scheren mit Hartmetallschneiden
 Scissors with Tungsten Carbide Edges
 Ciseaux avec des lames en tungstène
 Tijeras con filos de carburo de tungsteno



POTTS-SMITH

19 cm, 7 1/2"



04-1494.25

25°



04-1494.40

40°

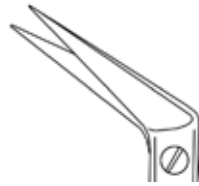

04-1494.60

60°



04-1525.22

22,5 cm, 8 3/4"



04-1527.22

22,5 cm, 8 3/4"

Parametriumscheren
 Parametrium Scissors
 Ciseaux à parametrium
 Tijeras para parametrio



SIMS



04-1534.23

23 cm, 9"



04-1525.23

23 cm, 9"

Scheren mit Hartmetallschneiden
Scissors with Tungsten Carbide Edges
Ciseaux avec des lames en tungstène
Tijeras con filos de carburo de tungsteno



UNIVERSAL

04-1735.12

12 cm, 4 3/4"



LISTER

04-1755.18

18 cm, 7"



BRUNS

04-1779.23

23 cm, 9"

Scheren mit Hartmetallschneiden
Scissors with Tungsten Carbide Edges
Ciseaux avec des lames en tungstène
Tijeras con filos de carburo tungsteno

04

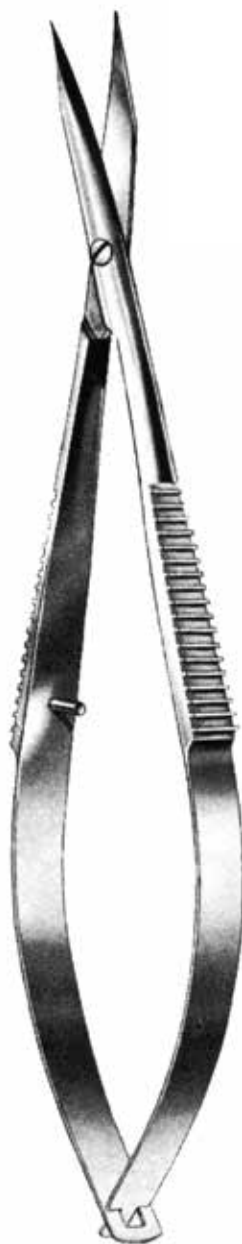

Augen- und Mikroscheren
Ophthalmic and Micro Scissors
Ciseaux oculaires et pour microchirurgie
Tijeras para oftalmología y microcirugía



WESTCOTT

05-1120.11

11 cm, 4 1/4"



WESTCOTT

05-1122.11

11 cm, 4 1/4"



NOYES

05-1124.12

12 cm, 4 3/4"



BARRAQUER

05-1131.10

5,5 cm, 2 1/4"



MC GUIRE

05-1133.10

10 cm, 4"



WECKER

05-1125.11

11 cm, 4 1/4"



WECKER

05-1127.11

11 cm, 4 1/4"



WECKER

05-1129.11

11 cm, 4 1/4"

05

Augen- und Mikroscheren
Ophthalmic and Micro Scissors
Ciseaux oculaires et pour microchirurgie
Tijeras para oftalmología y microcirugía



CASTROVIEJO

05-1135.10

10 cm, 4"



CASTROVIEJO

05-1137.10

10 cm, 4"



VANNAS

05-1140.08

8 cm, 3 1/4"



VANNAS

05-1141.08

8 cm, 3 1/4"



CASTROVIEJO

05-1143.11

11 cm, 4 1/4"



CASTROVIEJO

05-1145.11

11 cm, 4 1/4"



CASTROVIEJO

05-1147.11

11 cm, 4 1/4"

Augen- und Mikroscheren
Ophthalmic and Micro Scissors
Ciseaux oculaires et pour microchirurgie
Tijeras para oftalmología y microcirugía

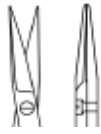

05-1152.18

18 cm, 7"



05-1153.18

18 cm, 7"

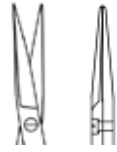

05-1156.18

18 cm, 7"



05-1157.18

18 cm, 7"

05

Pinzetten
Thumb and Tissue Forceps
Pincés à dissection
Pinzas de disección



06

Anatomische Pinzetten
Dissecting Forceps
Pinces à dissection
Pinzas de disección



06-0200.10	10,5 cm, 4 1/2"
06-0200.11	11,5 cm, 4 1/2"
06-0200.13	13 cm, 5"
06-0200.14	14,5 cm, 5 1/2"
06-0200.16	16 cm, 6 1/4"
06-0200.18	18 cm, 7"
06-0200.20	20 cm, 8"
06-0200.25	25 cm, 10"
06-0200.30	30 cm, 12"



06-0208.11	11,5 cm, 4 1/2"
06-0208.13	13 cm, 5"
06-0208.14	14,5 cm, 5 1/2"
06-0208.16	16 cm, 6 1/4"
06-0208.18	18 cm, 7"
06-0208.20	20 cm, 8"
06-0208.25	25 cm, 10"
06-0208.30	30 cm, 12"



USA-MODELL

06-0312.12	12 cm, 4 3/4"
06-0312.13	13 cm, 5"
06-0312.14	14,5 cm, 5 1/2"
06-0312.15	15,5 cm, 6"
06-0312.18	18 cm, 7"
06-0312.21	21 cm, 8 1/4"
06-0312.25	25 cm, 10"



STILLE

06-0320.15	15 cm, 5 3/4"
06-0320.17	17 cm, 6 3/4"



SEMKEN

06-0350.12	12,5 cm, 5"
06-0350.15	15 cm, 5 3/4"

06-0351.12	12,5 cm, 5"
06-0351.15	15 cm, 5 3/4"



MC INDOE

06-0360.15	15 cm, 5 3/4"
-------------------	---------------

Anatomische Pinzetten
Dissecting Forceps
Pinces à dissection
Pinzas de disección

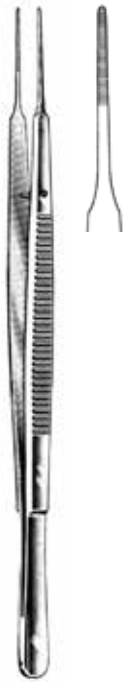

GERALD
06-0370.18
 18 cm, 7"



GERALD
06-0371.18
 18 cm, 7"



GERALD
06-0373.18
 18 cm, 7"



CUSHING
06-0390.17
 17 cm, 6 3/4"



ADSON
06-0380.12 12 cm, 4 3/4"
06-0380.15 15 cm, 5 3/4"



ADSON-MICRO
06-0386.12
 12 cm, 4 3/4"



POTTS-SMITH
06-0420.18 18 cm, 7"
06-0420.21 21 cm, 8 1/4"
06-0420.25 25 cm, 10"

Pinzetten mit Hartmetalleinlagen
Forceps with Tungsten Carbide Inserts
Pinces à dissection avec mors en tungstène
Pinzas de disección con bocas de carburo de tungsteno

06



06-0212.14 14,5 cm, 5 1/2"

06-0212.16 16 cm, 6 1/4"



ADSON

06-0384.12 12 cm, 4 3/4"

06-0384.15 15 cm, 5 3/4"



POTTS-SMITH

06-0424.18 18 cm, 7"

06-0424.21 21 cm, 8 1/4"

06-0424.25 25 cm, 10"

Chirurgische Pinzetten
Tissue Forceps
Pinces chirurgicales
Pinzas quirúrgicas



06-1200.10	10,5 cm, 4 3/4"
06-1200.11	11,5 cm, 4 1/2"
06-1200.13	13 cm, 5"
06-1200.14	14,5 cm, 5 1/2"
06-1200.16	16 cm, 6 1/4"
06-1200.18	18 cm, 7"
06-1200.20	20 cm, 8"
06-1200.25	25 cm, 10"
06-1200.30	30 cm, 12"



06-1208.11	11,5 cm, 4 1/2"
06-1208.13	13 cm, 5"
06-1208.14	14,5 cm, 5 1/2"
06-1208.16	18 cm, 6 1/4"
06-1208.18	16 cm, 7"
06-1208.20	20 cm, 8"
06-1208.25	25 cm, 10"



USA-MODELL	
06-1312.12	12 cm, 4 3/4"
06-1312.13	13 cm, 5"
06-1312.14	14,5 cm, 5 1/2"
06-1312.15	15,5 cm, 6"
06-1312.18	18 cm, 7"
06-1312.21	21 cm, 8 1/4"
06-1312.25	25 cm, 10"



06-1223.13	13 cm, 5"
06-1223.14	14,5 cm, 5 1/2"
06-1223.16	16 cm, 6 1/4"
06-1223.18	18 cm, 7"
06-1223.20	20 cm, 8"
06-1223.25	25 cm, 10"



06-1234.13	13 cm, 5"
06-1234.14	14,5 cm, 5 1/2"
06-1234.16	16 cm, 6 1/4"



06-1245.13	13 cm, 5"
06-1245.14	14,5 cm, 5 1/2"
06-1245.16	16 cm, 6 1/4"

Chirurgische Pinzetten
Tissue Forceps
Pincers chirurgicales
Pinzas quirúrgicas



STILLE

06-1320.15

15 cm, 5 3/4"



LANE

06-1332.14

14,5 cm, 5 1/2"



LANE

06-1334.14

14,5 cm, 5 1/2"



GILLIES

06-1366.15

15,5 cm, 6"



FERRIS-SMITH

06-1342.18

18 cm, 7"



FERRIS-SMITH

06-1344.18

18 cm, 7"

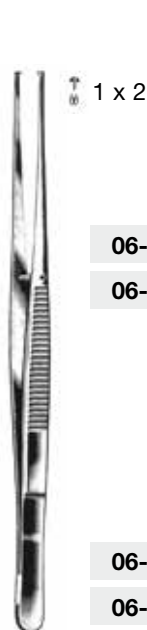

SEMKEN

06-1350.12 12,5 cm, 5"

06-1350.15 15 cm, 5 3/4"

06-1351.12 12,5 cm, 5"

06-1351.15 15 cm, 5 3/4"

Chirurgische Pinzetten
Tissue Forceps
Pinces chirurgicales
Pinzas quirúrgicas

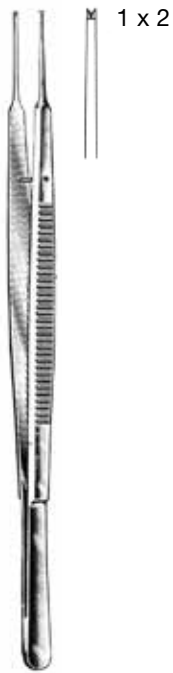

GERALD
06-1370.18
 18 cm, 7"



GERALD
06-1371.18
 18 cm, 7"

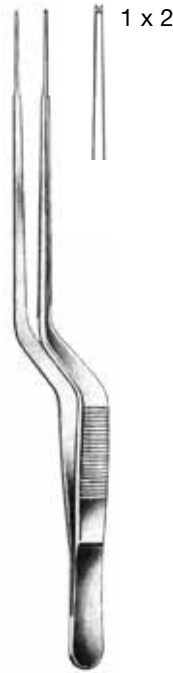

GERALD
06-1373.18
 18 cm, 7"



CUSHING
06-1390.17
 17 cm, 6 3/4"



ADSON
06-1380.12 12 cm, 4 3/4"
06-1380.15 15 cm, 5 3/4"



ADSON-MICRO
06-1386.12
 12 cm, 4 3/4"



POTTS-SMITH
06-1420.18 18 cm, 7"
06-1420.21 21 cm, 8 1/4"
06-1420.25 25 cm, 10"

Faßpinzetten
Grasping Forceps
Pinces pour saisir les tissus
Pinzas para agarrar



GRAEFE

06-5020.10

10,5 cm, 4"



LERCHE

06-5146.15

15 cm, 5 3/4"



ADLERKREUTZ

06-5110.15 15 cm, 5 3/4"

06-5110.20 20 cm, 8"



RUSS. MODELL

06-5210.15 15 cm, 5 3/4"

06-5210.20 20 cm, 8"

06-5210.25 25 cm, 10"

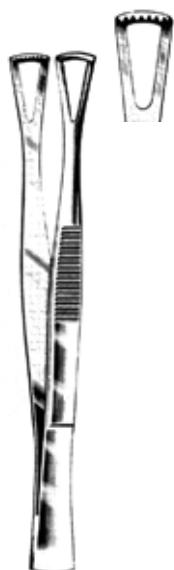

DUVAL

06-5314.07

14,5 cm, 5 1/2"



DUVAL-COLLIN

06-5320.20

20 cm, 8"



BROWN-ADSON

06-5340.12

12 cm, 4 3/4"



BROWN

06-5344.16 16 cm, 6 1/4"

06-5344.20 20 cm, 8"

06-5344.25 25 cm, 10"

Faßpinzetten
Grasping Forceps
Pinces pour saisir les tissus
Pinzas para agarrar



SINGLEY
06-5260.23
23 cm, 9"



NELSON
06-5270.23
23 cm, 9"



WANGENSTEEN
06-5330.23
23 cm, 9"

Splitterpinzetten
Splinter Forceps
Pinces à échardes
Pinzas para espinas

No. 3



MOD SWITZERLAND

06-5862.11

11,5 cm, 4 1/4"

No. 4



MOD SWITZERLAND

06-5864.11

11,5 cm, 4 1/4"

No. 5



MOD SWITZERLAND

06-5866.11

11,5 cm, 4 1/4"

No. 7



MOD SWITZERLAND

06-5867.11

11,5 cm, 4 1/4"



06-5920.09 9 cm, 3 1/2"

06-5920.11 11 cm, 4 1/4"



FEILCHENFELD

06-5902.07 7 cm, 2 3/4"

06-5902.09 9 cm, 3 1/2"

06-5902.11 11,5 cm, 4 1/2"



06-5906.10

10,5 cm, 4"



06-5907.10

10,5 cm, 4"



06-5908.10

10,5 cm, 4"



06-5909.10

10,5 cm, 4"



CARMALT

Splitterzangen
Splinter Forceps
Pinces à échardes
Pinzas para espinas



PEET
06-5935.11
 11,5 cm, 4 1/4"



STIEGLITZ



06-5932.13
 13,5 cm, 5 1/4"



06-5933.13
 13,5 cm, 5 1/4"



ARCHER



06-5934.14
 14 cm, 5 1/2"



06-5935.14
 14 cm, 5 1/2"



RALK
06-5938.15
 15 cm, 5 3/4"

Pinzetten für die Mikrochirurgie, Atraumatische Pinzetten
Microsurgery Forceps, Atraumatic Forceps
Pinces à microchirurgie, Pinces atraumatiques
Pinzas para microcirugía, Pinzas atraumáticas



06-7022.12	12 cm, 4 3/4"
06-7022.15	15 cm, 5 3/4"
06-7022.18	18 cm, 7"



06-7023.12	12 cm, 4 3/4"
06-7023.15	15 cm, 5 3/4"
06-7023.18	18 cm, 7"

2,0 mm



06-8032.16	16 cm, 6 1/4"
06-8032.20	20 cm, 8"



COOLEY

1,5 mm



06-8016.16	16 cm, 6 1/4"
06-8016.20	20 cm, 8"
06-8016.24	24 cm, 9 1/2"

2,0 mm



06-8028.16	16 cm, 6 1/4"
06-8028.20	20 cm, 8"
06-8028.24	24 cm, 9 1/2"
06-8028.30	30 cm, 12"

2,0 mm



06-8029.16	16 cm, 6 1/4"
06-8029.20	20 cm, 8"
06-8029.24	24 cm, 9 1/2"
06-8029.30	30 cm, 12"



DE BAKEY

2,7 mm



06-8014.16	16 cm, 6 1/4"
06-8014.20	20 cm, 8"
06-8014.24	24 cm, 9 1/2"
06-8014.30	30 cm, 12"

3,5 mm



06-8030.16	16 cm, 6 1/4"
06-8030.20	20 cm, 8"
06-8030.24	24 cm, 9 1/2"
06-8030.30	30 cm, 12"

Klemmen
Forceps
Pinces
Pinzas

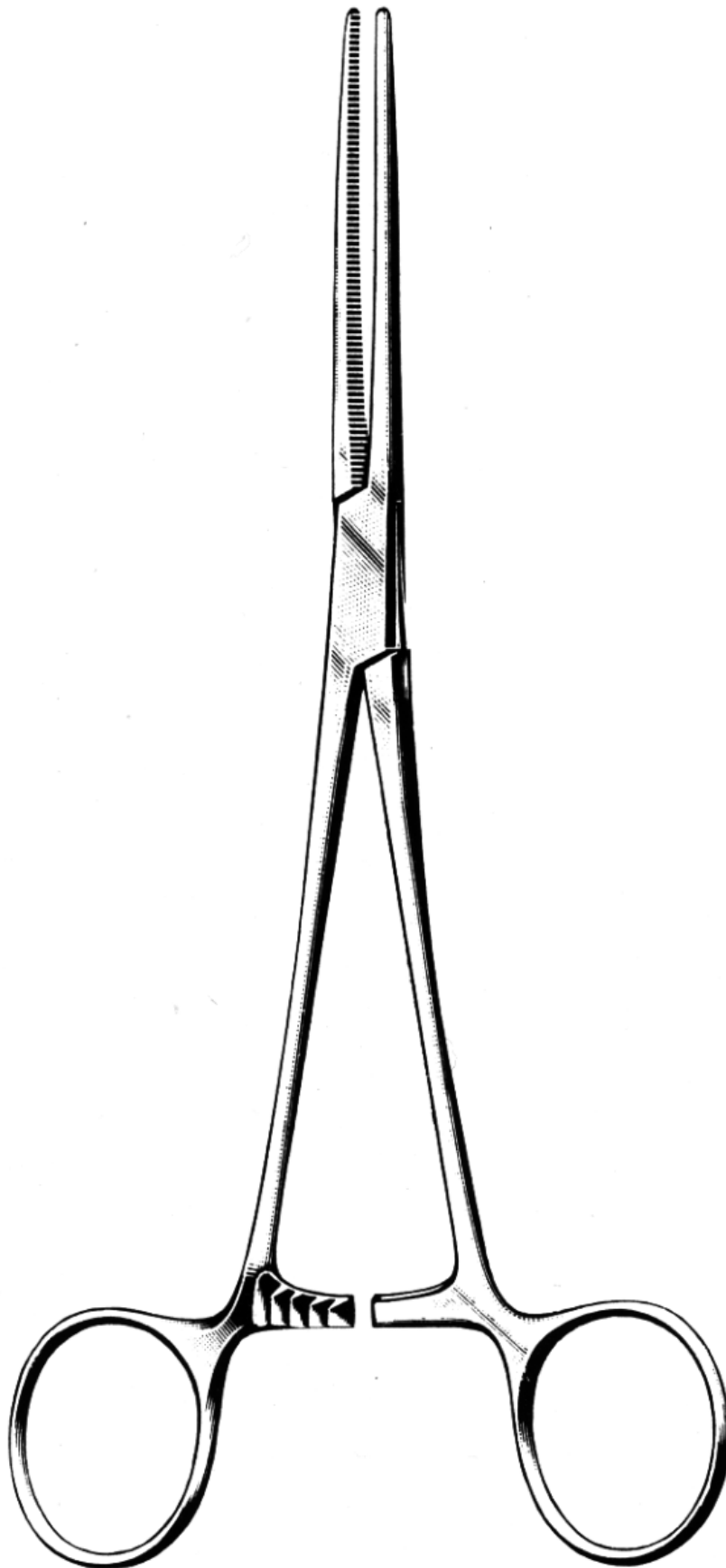

07

Atraumatische Bulldogklemmen
Atrauma Bulldog Clamps
Clamps Bulldog atraumatiques
Clamps Bulldog atraumáticos



DE BAKEY



07-0070.07

7,5 cm, 3"



07-0070.08

8,5 cm, 3 1/2"



07-0070.10

10,5 cm, 4"



07-0070.12

12 cm, 4 3/4"



07-0071.07

7,5 cm, 3"



07-0071.08

8,5 cm, 3 1/2"



07-0071.10

10,5 cm, 4"



07-0071.12

12 cm, 4 3/4"



GLOVER



07-0150.06

6 cm, 2 1/2"



07-0150.07

7 cm, 2 3/4"



07-0150.09

9 cm, 3 1/2"



07-0150.11

11 cm, 4 1/4"



07-0151.06

5,5 cm, 2 1/4"



07-0151.07

6,5 cm, 2 3/4"



07-0151.09

8,5 cm, 3 1/2"



07-0151.11

10,5 cm, 4"

07

Arterienklemmen
Hemostatic Forceps
Pinces hémostatiques
Pinzas hemostáticas



07-0160.04

3,5 cm, 1 1/2"

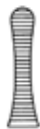

07-0160.05

5,5 cm, 2 1/4"



07-0161.04

3,5 cm, 1 1/2"



07-0161.05

5,5 cm, 2 1/4"



DIEFFENBACH



07-0170.50

5 cm, 2"



07-0170.55

5,5 cm, 2 1/4"

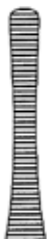

07-0170.65

6,5 cm, 2 3/4"



07-0170.70

7 cm, 3"



07-0170.75

7,5 cm, 3 1/4"



07-0170.90

9 cm, 3 1/2"



07-0171.50

5 cm, 2"



07-0171.55

5,5 cm, 2 1/4"



07-0171.65

6,5 cm, 2 3/4"



07-0171.70

7 cm, 3"



07-0171.75

7,5 cm, 3 1/4"



07-0171.90

9 cm, 3 1/2"



JOHNS-HOPKINS

Arterienklemmen
Hemostatic Forceps
Pinces hémostatiques
Pinzas hemostáticas



07-0520.10
10 cm, 4"



07-0521.10
10 cm, 4"



HARTMANN



07-0522.10
10 cm, 4"



07-0523.10
10 cm, 4"

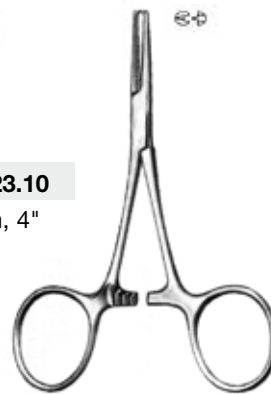

HARTMANN



07-0600.12
12,5 cm, 5"



07-0601.12
12,5 cm, 5"

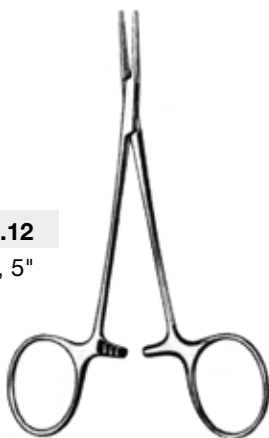

MICRO-MOSQUITO



07-0602.12
12,5 cm, 5"



07-0603.12
12,5 cm, 5"



MICRO-MOSQUITO

Arterienklemmen
 Hemostatic Forceps
 Pinces hémostatiques
 Pinzas hemostáticas



HALSTEAD-MOSQUITO

07-0620.12	12,5 cm, 5"
07-0620.14	14 cm, 5 1/2"
07-0620.18	18 cm, 7"
07-0620.21	21 cm, 8 1/4"



HALSTEAD-MOSQUITO

07-0621.12	12,5 cm, 5"
07-0621.14	14 cm, 5 1/2"
07-0621.18	18 cm, 7"
07-0621.21	21 cm, 8 1/4"



HALSTEAD-MOSQUITO

07-0622.12	12,5 cm, 5"
07-0622.14	14 cm, 5 1/2"
07-0622.18	18 cm, 7"
07-0622.21	21 cm, 8 1/4"



HALSTEAD-MOSQUITO

07-0623.12	12,5 cm, 5"
07-0623.14	14 cm, 5 1/2"
07-0623.18	18 cm, 7"
07-0623.21	21 cm, 8 1/4"

Arterienklemmen
 Hemostatic Forceps
 Pinces hémostatiques
 Pinzas hemostáticas



07-0800.14
 14 cm, 5 1/2"



07-0801.14
 14 cm, 5 1/2"

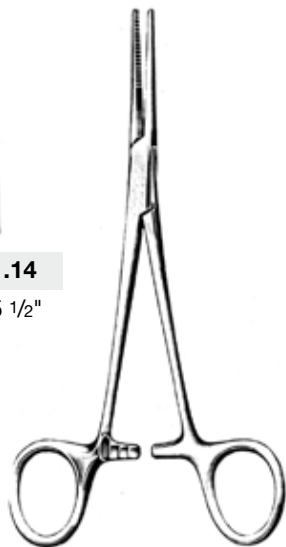

KELLY



07-0802.16
 16 cm, 6 1/2"



07-0803.16
 16 cm, 6 1/2"



KELLY-RANKIN



07-0820.14
 14 cm, 5 1/2"



07-0821.14
 14 cm, 5 1/2"

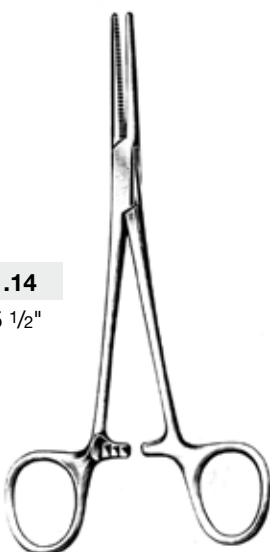

CRILE



07-0822.14
 14 cm, 5 1/2"



07-0823.14
 14 cm, 5 1/2"



CRILE

Arterienklemmen
 Hemostatic Forceps
 Pinces hémostatiques
 Pinzas hemostáticas



07-0826.16
 16 cm, 6 1/2"



07-0827.16
 16 cm, 6 1/2"



CRILE-RANKIN



07-0828.16
 16 cm, 6 1/2"



07-0829.16
 16 cm, 6 1/2"



CRILE-RANKIN



07-0726.14
 14 cm, 5 1/2"



07-0727.14
 14 cm, 5 1/2"

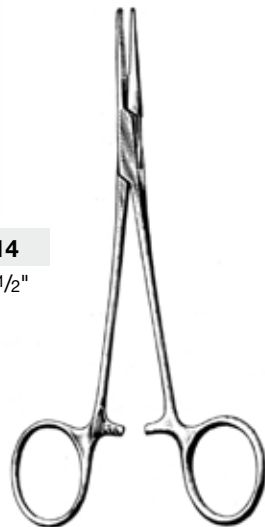

PROVIDENCE-HOSPITAL



07-0930.14
 14 cm, 5 1/2"



07-0931.14
 14 cm, 5 1/2"



PEAN

Arterienklemmen
Hemostatic Forceps
Pincas hémostatiques
Pinzas hemostáticas

07



07-0940.13

13 cm, 5"



07-0940.14

14 cm, 5 1/2"



07-0940.16

16 cm, 6 1/2"



07-0940.18

18 cm, 7"



07-0940.20

20 cm, 8"



07-0940.22

22 cm, 8 1/2"



07-0940.24

24 cm, 9 1/2"



07-0940.26

26 cm, 10 1/4"



07-0940.28

28 cm, 11"



07-0940.30

30 cm, 12"



ROCHESTER-PEAN

Arterienklemmen
Hemostatic Forceps
Pinces hémostatiques
Pinzas hemostáticas

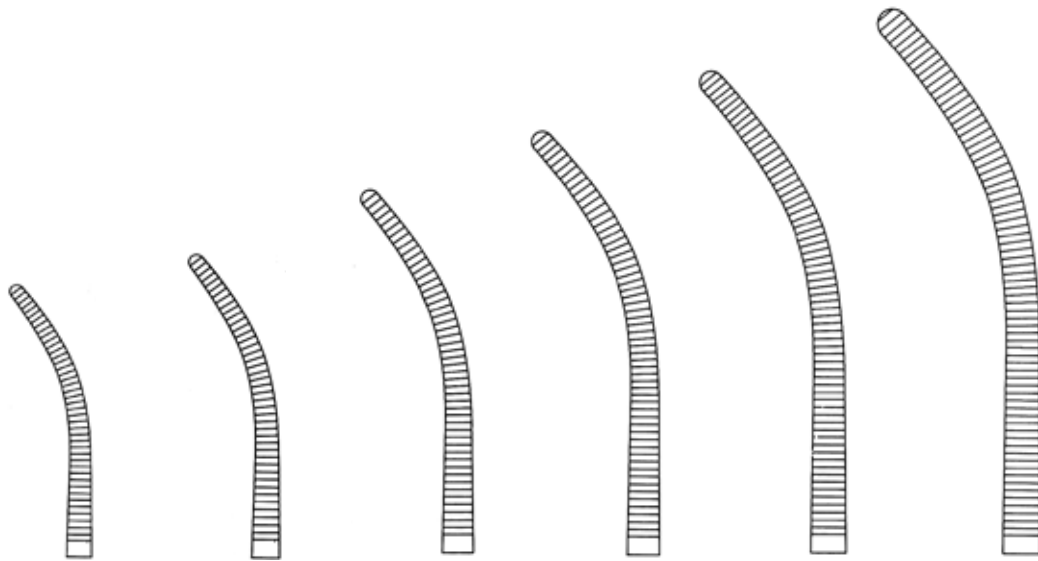

07-0941.13

13 cm, 5"

07-0941.14

14 cm, 5 1/2"

07-0941.16

16 cm, 6 1/2"

07-0941.18

18 cm, 7"

07-0941.20

20 cm, 8"

07-0941.22

22 cm, 8 1/2"

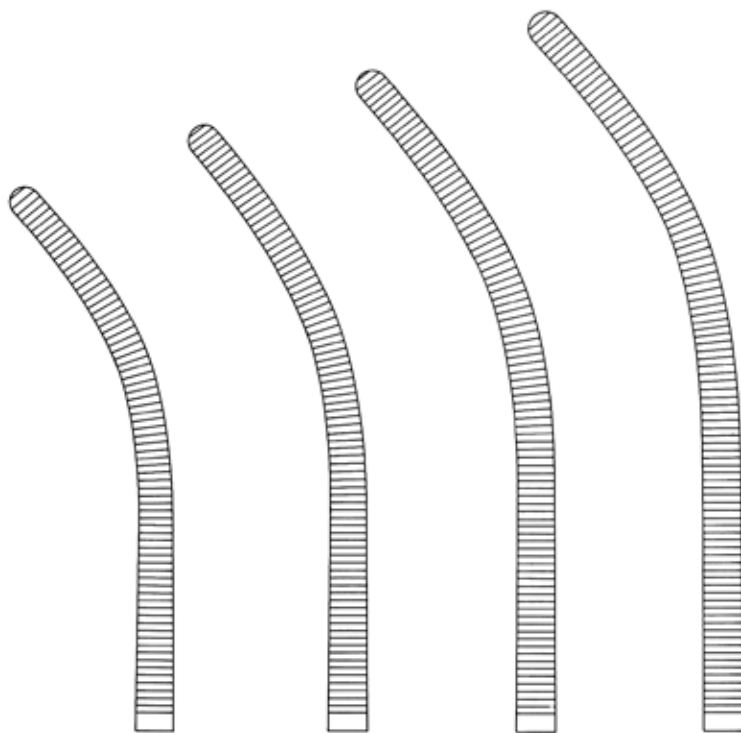

07-0941.24

24 cm, 9 1/2"

07-0941.26

26 cm, 10 1/4"

07-0941.28

28 cm, 11"

07-0941.30

30 cm, 12"



ROCHESTER-PEAN

Arterienklemmen
 Hemostatic Forceps
 Pincas hémostatiques
 Pinzas hemostáticas

07



07-1030.13

13 cm, 5"



07-1030.14

14 cm, 5 1/2"



07-1030.16

16 cm, 6 1/2"



07-1030.18

18 cm, 7"



07-1030.20

20 cm, 8"



07-1030.22

22 cm, 8 1/2"



07-1030.24

24 cm, 9 1/2"



07-1030.26

26 cm, 10 1/4"



07-1030.28

28 cm, 11"



07-1030.30

30 cm, 12"



ROCHESTER-OGHSNER

Arterienklemmen
Hemostatic Forceps
Pinces hémostatiques
Pinzas hemostáticas

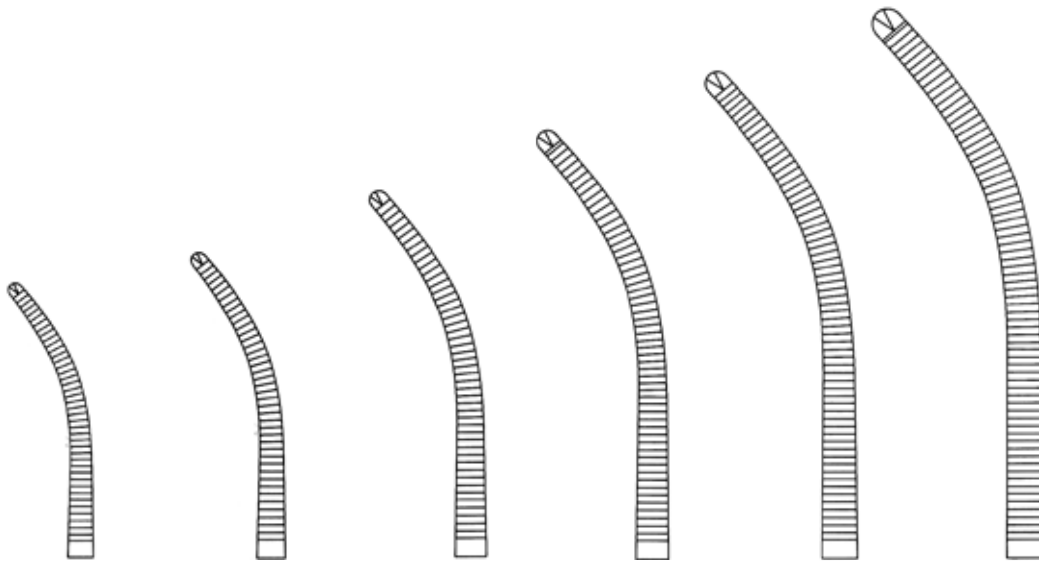

07-1031.13

13 cm, 5"

07-1031.14

14 cm, 5 1/2"

07-1031.16

16 cm, 6 1/2"

07-1031.18

18 cm, 7"

07-1031.20

20 cm, 8"

07-1031.22

22 cm, 8 1/2"

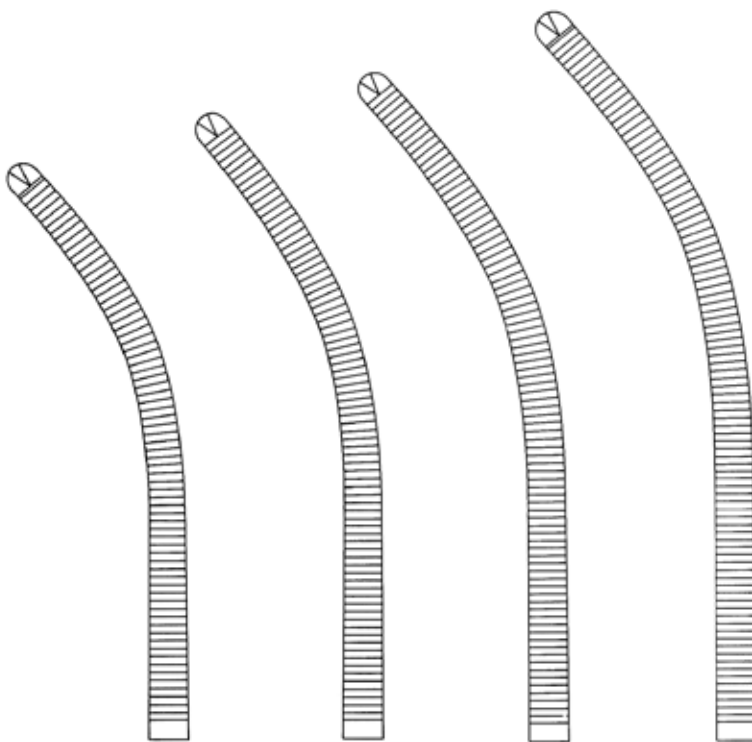

07-1031.24

24 cm, 9 1/2"

07-1031.26

26 cm, 10 1/4"

07-1031.28

28 cm, 11"

07-1031.30

30 cm, 12"



ROCHESTER-OGHSNER

Arterienklemmen
 Hemostatic Forceps
 Pincas hémostatiques
 Pinzas hemostáticas



07-1028.14
 14 cm, 5 1/2"



07-1029.14
 14 cm, 5 1/2"



KOCHER



07-1050.14
 14 cm, 5 1/2"



07-1051.14
 14 cm, 5 1/2"



SPENCER-WELLS



07-0860.16
 16 cm, 6 1/2"



07-0861.16
 16 cm, 6 1/2"



07-0860.20
 20 cm, 8"



07-0861.20
 20 cm, 8"



ROCHESTER-CARMALT

07

Arterienklemmen
Hemostatic Forceps
Pinces hémostatiques
Pinzas hemostáticas

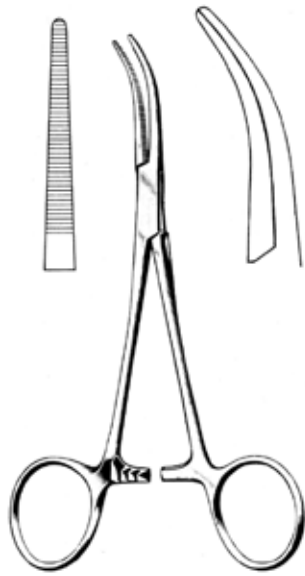

DANDY

07-0671.14

14 cm, 5 1/2"

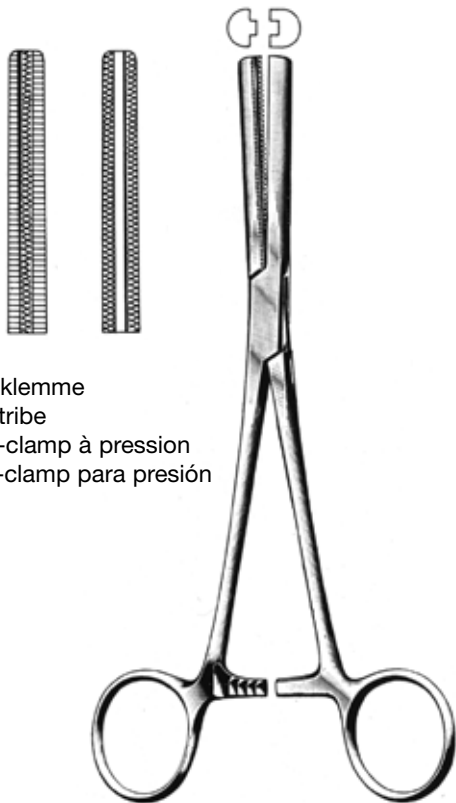

Druckklemme
 Angiotribe
 Pince-clamp à pression
 Pinza-clamp para presión

FERGUSON

07-4524.16

16 cm, 6 1/2"

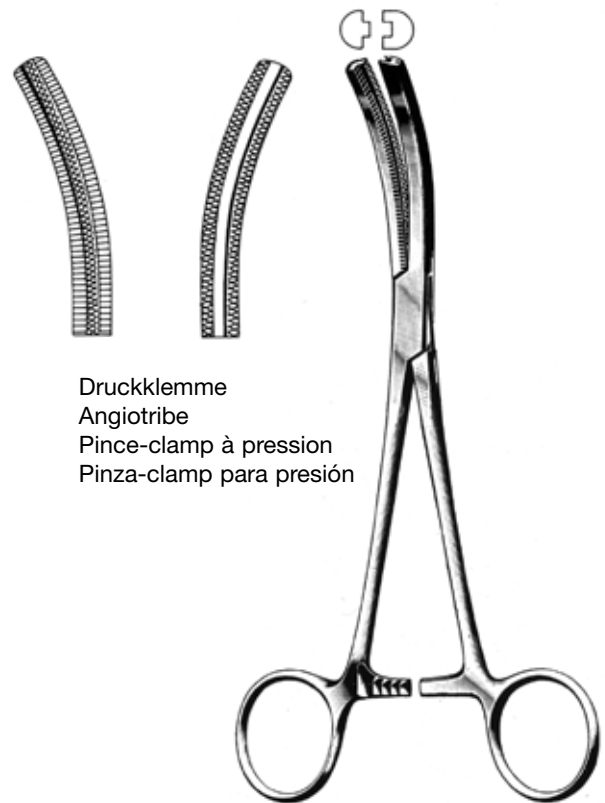

Druckklemme
 Angiotribe
 Pince-clamp à pression
 Pinza-clamp para presión

FERGUSON

07-4525.16

16 cm, 6 1/2"

Arterienklemmen, Gewebefäßzangen
 Hemostatic Forceps, Intestinal Tissue Forceps
 Pincés hémostatiques, Pincés pour saisir le tissu
 Pinzas hemostáticas, Pinzas para coger tejidos

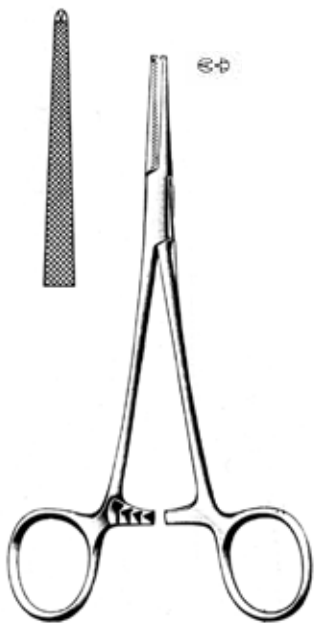

LOVELACE
 07-4377.15
 15,5 cm, 6"



PENNINGTON
 07-4372.15
 15 cm, 5 3/4"



PRATT
 07-4504.15
 15 cm, 5 3/4"

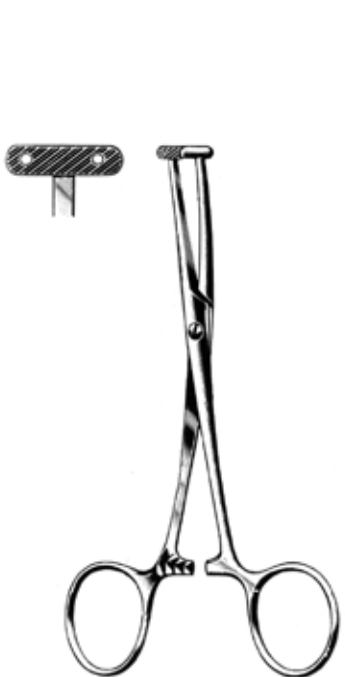

DeMARTEL
 07-4501.14
 14 cm, 5 1/2"



WILLET-MARTEL
 07-4501.19
 19 cm, 7 1/2"

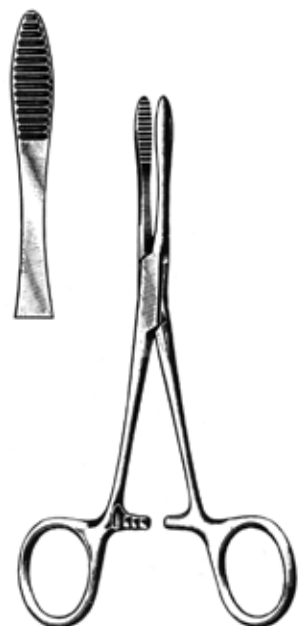

PEAN
 07-0920.14
 14 cm, 5 1/2"

07

Arterienklemmen
Hemostatic Forceps
Pincès hémostatiques
Pinzas hemostáticas

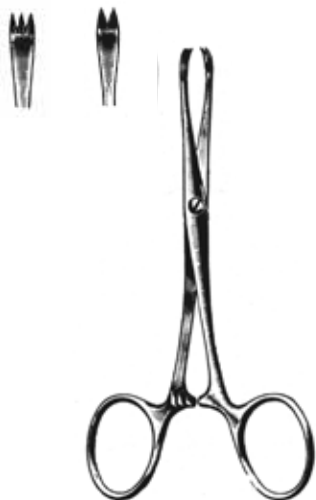

CHAPUT

07-4312.13

13 cm, 5"



TUFFIER

07-4310.13

13 cm, 5"



COLLIN

07-4350.14

14 cm, 5 1/2"



COLLIN

07-4542.16

16 cm, 6 1/2"

Arterienklemmen
 Hemostatic Forceps
 Pinces hémostatiques
 Pinzas hemostáticas

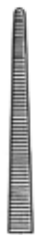

07-0710.15

15 cm, 5 3/4"



07-0711.15

15 cm, 5 3/4"



LERICHE



07-0712.15

15 cm, 5 3/4"



07-0713.15

15 cm, 5 3/4"



LERICHE



07-0774.20

20 cm, 8"



07-0775.20

20 cm, 8"



BENGOLEA



07-0776.20

20 cm, 8"



07-0777.20

20 cm, 8"



BENGOLEA

07-0774.26

26 cm, 10 1/4"

07-0775.26

26 cm, 10 1/4"

07-0776.26

26 cm, 10 1/4"

07-0777.26

26 cm, 10 1/4"

Arterienklemmen
Hemostatic Forceps
Pincès hémostatiques
Pinzas hemostáticas



07-0730.20

20 cm, 8"



07-0731.20

20 cm, 8"



07-0733.20

20 cm, 8"



HEISS



07-0650.19

19 cm, 7 1/2"



07-0651.19

19 cm, 7 1/2"



ADSON

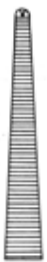

07-0652.19

19 cm, 7 1/2"

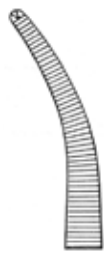

07-0653.19

19 cm, 7 1/2"



ADSON



ADSON-BABY

07-0655.18

18,5 cm, 7 1/4"

Präparier- und Ligaturklemmen
Dissecting and Ligature Forceps
Pinces à dissection et à ligatures
Pinzas para disección y ligaduras

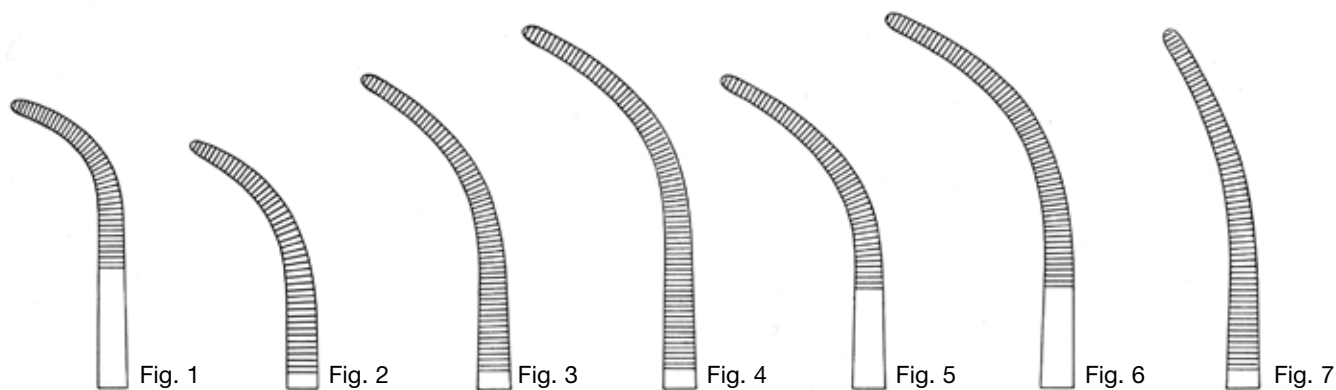

07-1711.01

21 cm, 8 1/4"

07-1711.02

21 cm, 8 1/4"

07-1711.03

21 cm, 8 1/4"

07-1711.04

21 cm, 8 1/4"

07-1711.05

21 cm, 8 1/4"

07-1711.06

21 cm, 8 1/4"

07-1711.07

21 cm, 8 1/4"

07-1713.01

27 cm, 10 1/2"

07-1713.02

27 cm, 10 1/2"

07-1713.03

27 cm, 10 1/2"

07-1713.04

27 cm, 10 1/2"

07-1713.05

27 cm, 10 1/2"

07-1713.06

27 cm, 10 1/2"

07-1713.07

27 cm, 10 1/2"



OVERHOLT-GEISSENDOERFER

07

Präparier- und Ligaturklemmen
Dissecting and Ligature Forceps
Pinces à dissection et à ligatures
Pinzas para disección y ligaduras

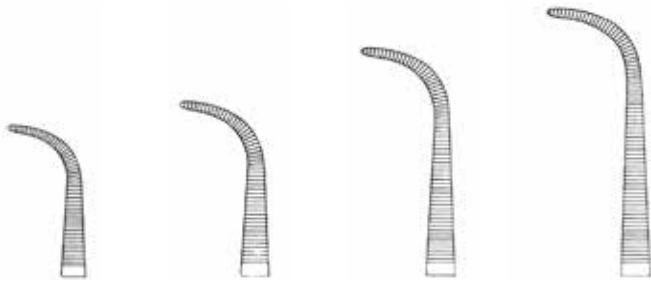

07-1743.13

13 cm, 5"



07-1743.16

16 cm, 6 1/4"



07-1743.18

18 cm, 7"



07-1743.20

20 cm, 8"

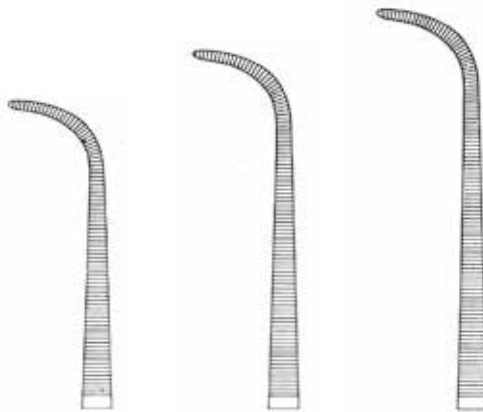

07-1743.23

23 cm, 9"



07-1743.25

25 cm, 10"



07-1743.28

28 cm, 11"



GEMINI

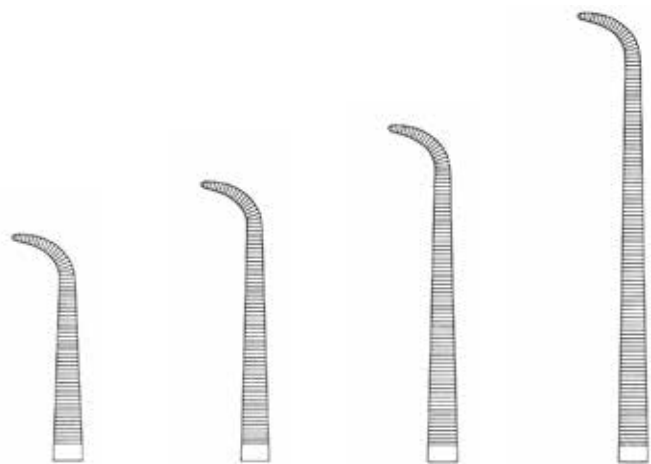

07-1745.18

18 cm, 7"

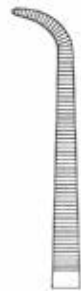

07-1745.22

22 cm, 8 1/2"



07-1745.25

25 cm, 10"



07-1745.28

28 cm, 11"



GEMINI (MIXTER)

Präparier- und Ligaturklemmen
Dissecting and Ligature Forceps
Pinces à dissection et à ligatures
Pinzas para disección y ligaduras

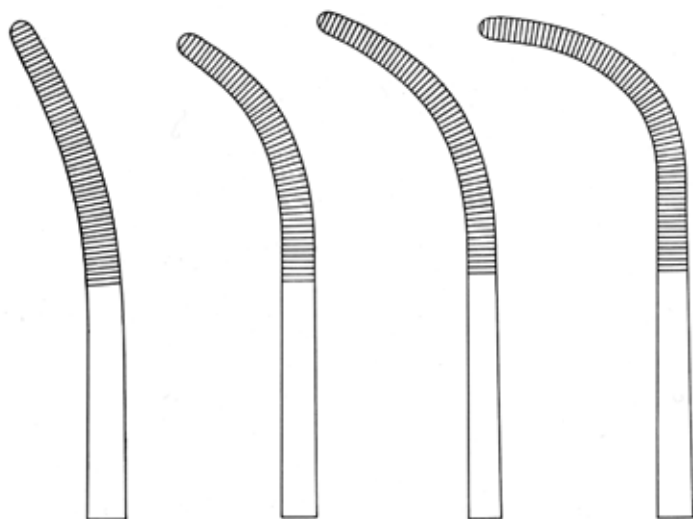

07-1701.01

23 cm, 9"

07-1701.02

23 cm, 9"

07-1701.03

23 cm, 9"

07-1701.04

23 cm, 9"



RUMMEL

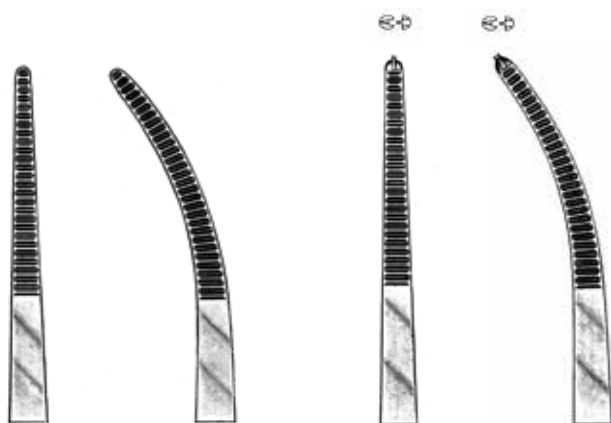

07-1080.21

21 cm, 8 1/4"

07-1081.21

21 cm, 8 1/4"

07-1082.21

21 cm, 8 1/4"

07-1083.21

21 cm, 8 1/4"



TOENNIS

07

Präparier- und Ligaturklemmen
Dissecting and Ligature Forceps
Pinces à dissection et à ligatures
Pinzas para disección y ligaduras

Bronchusklemmen
Bronchus Forceps
Pinces-clamps bronchiques
Pinzas-clamps para bronquios

07



07-1070.22
22 cm, 8 1/2"



07-1071.22
22 cm, 8 1/2"



ROBERTS



07-1066.24
24 cm, 9 1/2"



07-1067.24
24 cm, 9 1/2"



SAROT



CRAFOORD

07-0751.24

24 cm, 9 1/2"

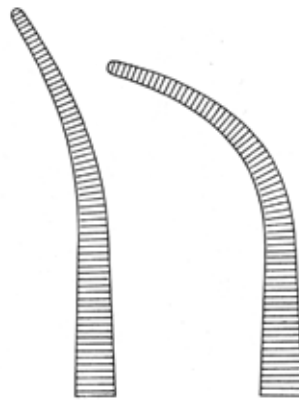

07-1059.01

07-1059.02

29,5 cm, 11 1/2" 29,5 cm, 11 1/2"



ZENKER

Präparier- und Ligaturklemmen
Dissecting and Ligature Forceps
Pinces à dissection et à ligatures
Pinzas para disección y ligaduras

07



LAWRENCE

07-1115.28

28 cm, 11"



MEEKER

07-1109.28

28 cm, 11"

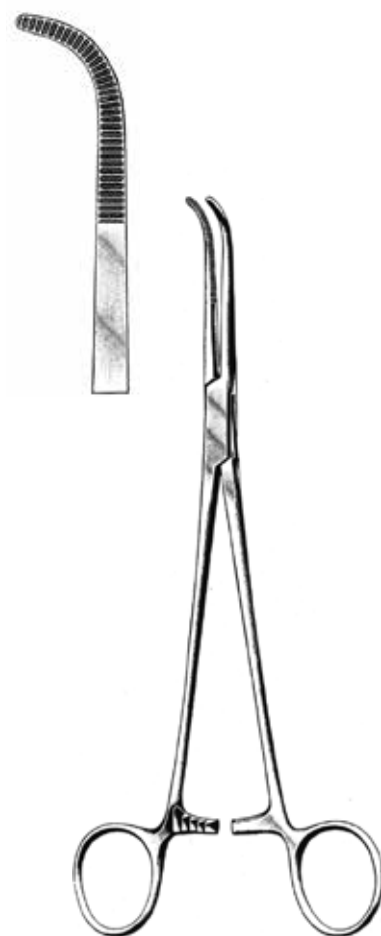

MIXTER

07-1573.22

22 cm, 8 1/2"

Arterien-, Gallenkanal-, Nierenstiellklemmen
Hemostatic, Gall Duct and Kidney Pedicle Forceps
Pinces hémostatiques, pédicule renal et voies biliaires
Pinzas hemostáticas, pedículo renal y vías biliaires

07



MIXTER

07-1583.14	14 cm, 5 1/2"
07-1583.16	16 cm, 6 1/4"
07-1583.18	18 cm, 7"
07-1583.23	23 cm, 10"



MIXTER-BABY

07-1521.14	14 cm, 5 1/2"
-------------------	---------------



MIXTER-BABY

07-1521.18	18 cm, 7"
-------------------	-----------



MIXTER-O'SHAUGNESSY

07-1523.15	15,5 cm, 6"
-------------------	-------------

07-1523.18	18 cm, 7"
-------------------	-----------

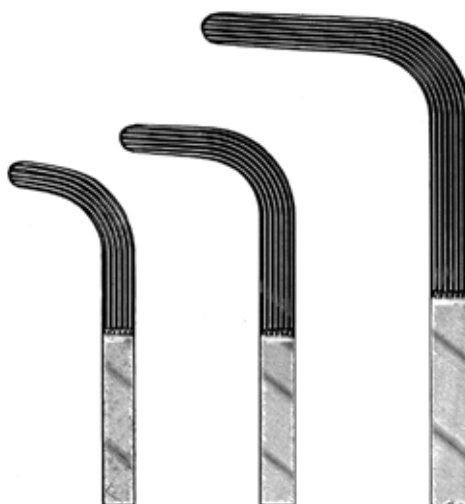

07-1563.22	22 cm, 8 1/2"
-------------------	---------------

07-1563.25	25 cm, 10"
-------------------	------------

07-1563.28	28 cm, 11"
-------------------	------------



MIXTER

Arterien-, Gallenkanal-, Nierenstielklemmen
Hemostatic, Gall Duct and Kidney Pedicle Forceps
Pincas hémostatiques, pédicule renal et voies biliaires
Pinzas hemostáticas, pedículo renal y vías biliares



07-0840.15
15 cm, 5 3/4"



07-0841.15
15 cm, 5 3/4"



BAINBRIDGE

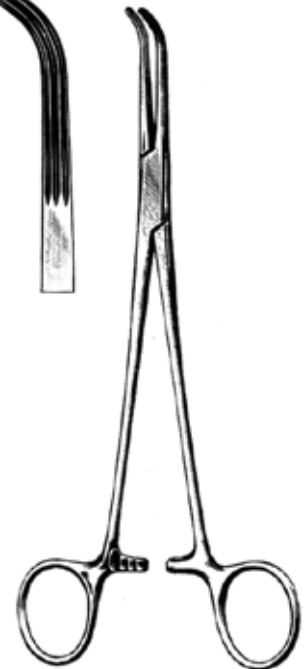

LAHEY

07-1551.19
19 cm, 7 1/2"



LAHEY

07-1551.23
23 cm, 9"

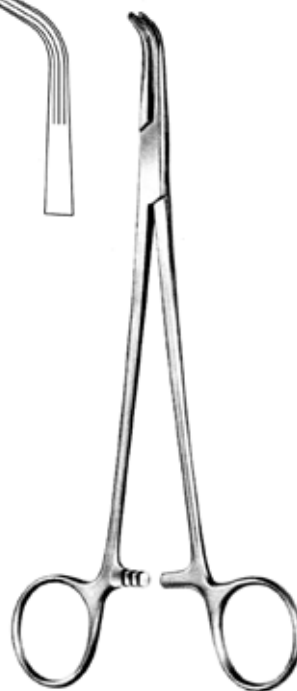

LOWER

07-4825.18
18 cm, 7"



JOHNS-HOPKINS

07-1559.20
20 cm, 8"

Arterien-, Gallenkanal-, Nierenstiellklemmen
Hemostatic, Gall Duct and Kidney Pedicle Forceps
Pinces hémostatiques, pédicule renal et voies biliaires
Pinzas hemostáticas, pedículo renal y vías biliaires

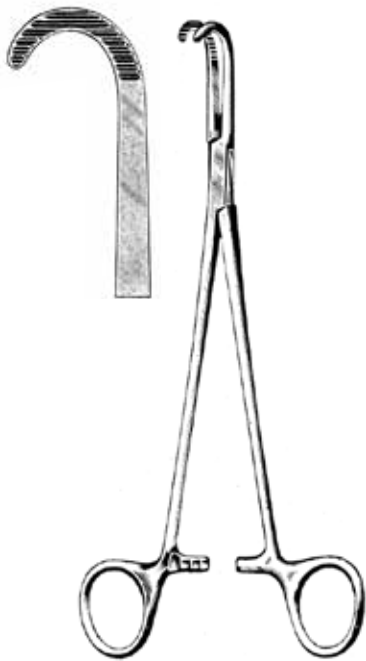

DESJARDINS

07-4837.21

21 cm, 8 1/4"



DESJARDINS

07-4841.21

21 cm, 8 1/4"



MIXTER

07-1539.26

16,5 cm, 6 1/2"



MOYNIHAN

07-4865.23

23 cm, 9"



STILLE

07-4601.23

23 cm, 9"

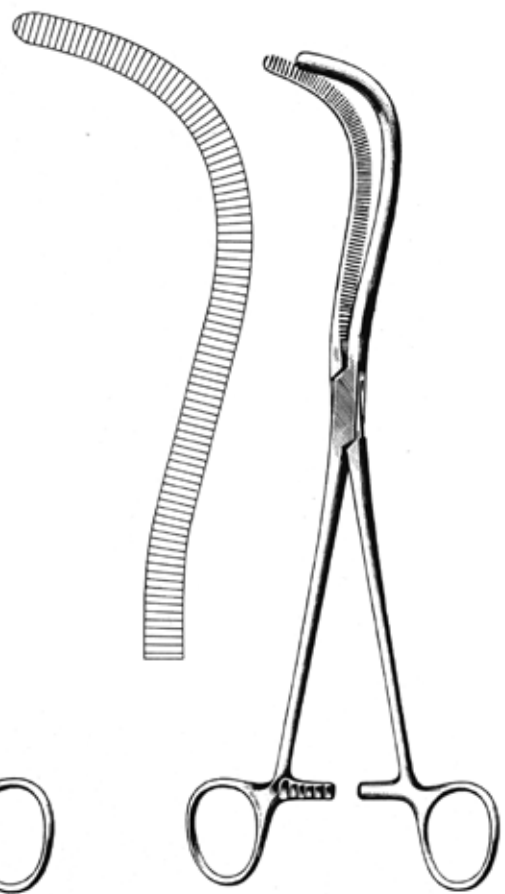

MAYO-GUYON

07-4627.23

23 cm, 9"

07

Arterien-, Gallenkanal-, Nierenstielklemmen
Hemostatic, Gall Duct and Kidney Pedicle Forceps
Pinces hémostatiques, pédicule renal et voies biliaires
Pinzas hemostáticas, pedículo renal y vías biliares

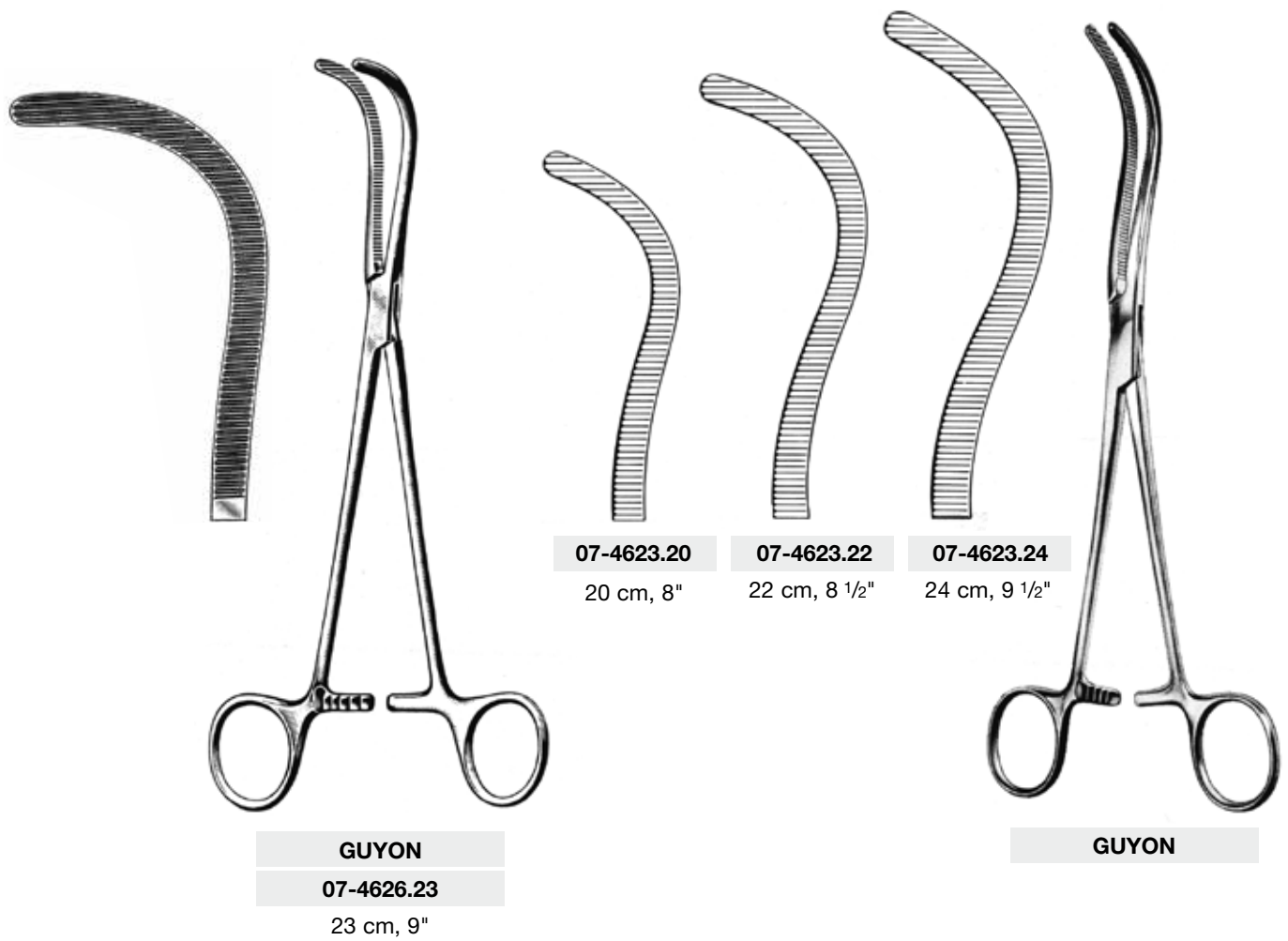

07-4623.20
20 cm, 8"

07-4623.22
22 cm, 8 1/2"

07-4623.24
24 cm, 9 1/2"

GUYON
07-4626.23
23 cm, 9"

GUYON

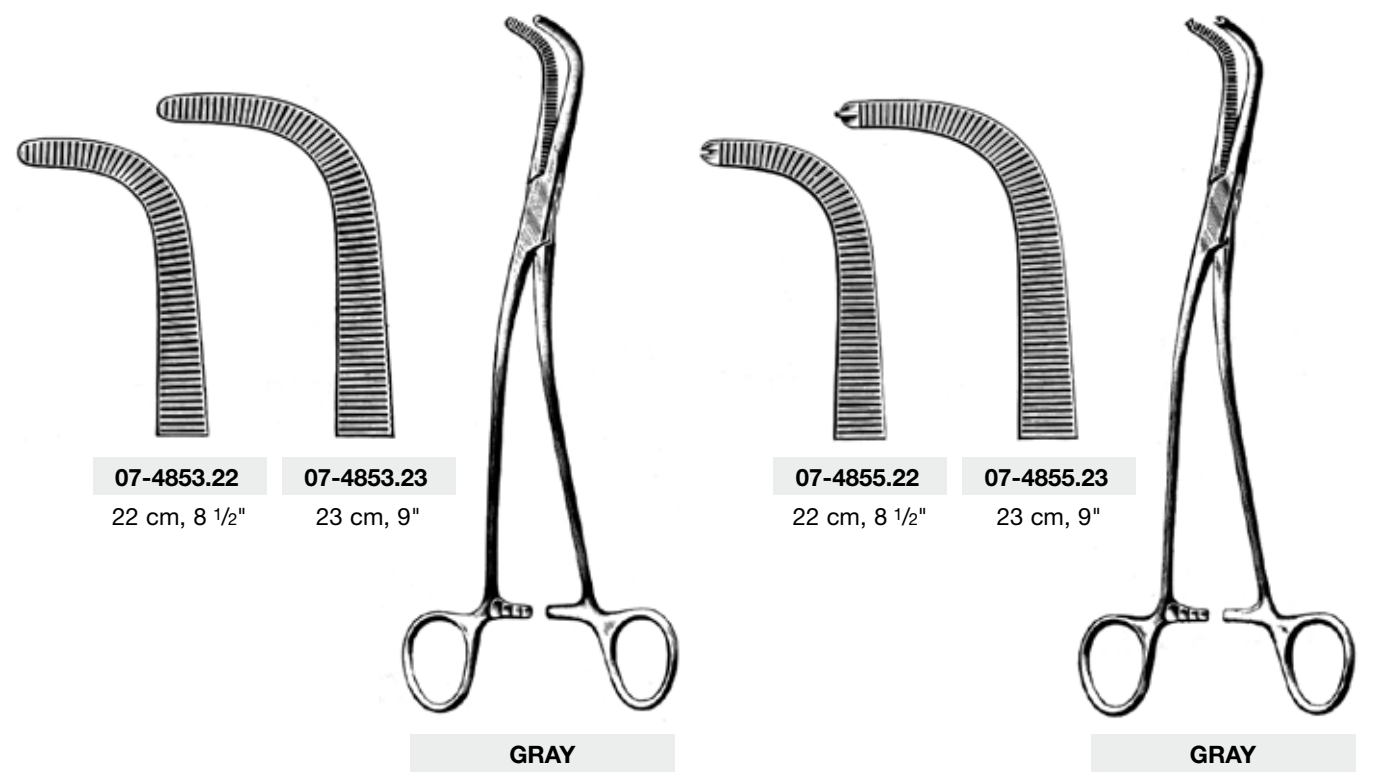

07-4853.22
22 cm, 8 1/2"

07-4853.23
23 cm, 9"

07-4855.22
22 cm, 8 1/2"

07-4855.23
23 cm, 9"

GRAY

GRAY

Nierenstielklemmen, Peritoneumklemmen, Hyterektomieklemmen
Kidney Pedicle Forceps, Peritoneum Forceps, Hyterectomy Forceps
Clamps rénaux, Pincas-clamps pour le péritoine, Pincas à hystérectomie
Pinzas-clamps renales, Pinzas-clamps para peritoneo, Pinzas-clamps para histerectomía

07

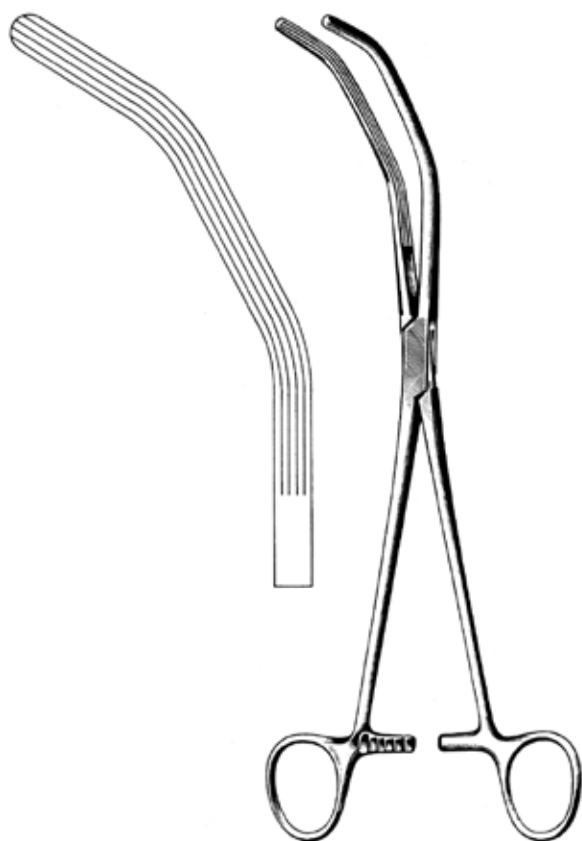

HERRICK
07-4621.23
 23 cm, 9"

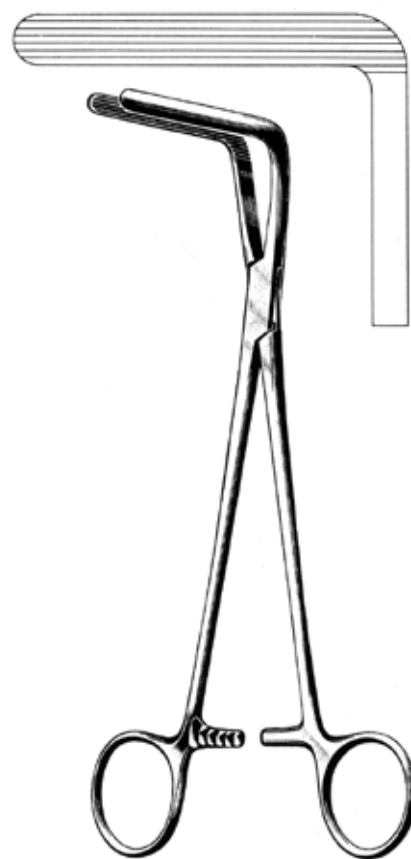

WERTHEIM-CULLEN
07-6127.21
 21,5 cm, 8 1/4"



07-6100.21
 21 cm, 8 1/4"

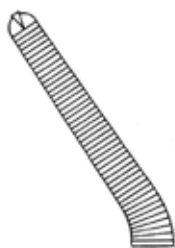

07-6101.21
 21 cm, 8 1/4"



PHANEUF



07-6135.23
 23 cm, 9"



07-6136.23
 23 cm, 9"



WERTHEIM

Nierenstielklemmen, Peritoneumklemmen, Hyterektomieklemmen
Kidney Pedicle Forceps, Peritoneum Forceps, Hyterectomy Forceps
Clamps rénaux, Pincas-clamps pour le péritoine, Pincas à hystérectomie
Pinzas-clamps renales, Pinzas-clamps para peritoneo, Pinzas-clamps para histerectomía



MICULICZ
07-6223.20
 20 cm, 8"



07-6243.20
 20 cm, 8"



07-6245.20
 20 cm, 8"



FAURE



WERTHEIM
07-4613.25
 25 cm, 10"



HEANEY
07-6321.20
 20 cm, 8"



HEANEY
07-6323.20
 20 cm, 8"

Schlauchklemmen
 Tubing Clamps
 Pincas serre-tubes
 Pinzas-clamps para tubos

07



MOD. BERLIN
 07-9906.14
 14,5 cm, 5 1/2"

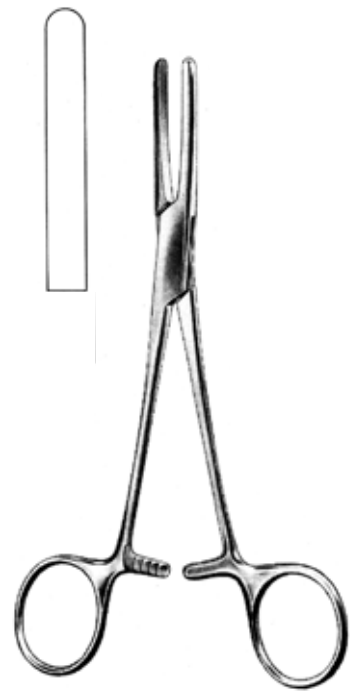

PRESBYTERIAN-HOSPITAL
 07-9912.16
 16 cm, 6 1/4"



07-9900.15
 15 cm, 5 3/4"



07-9900.18
 18 cm, 7"



07-9900.20
 20 cm, 8"

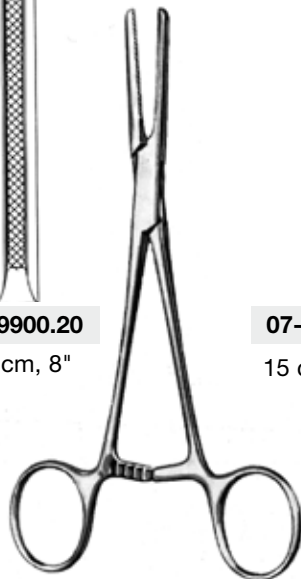

07-9902.15
 15 cm, 5 3/4"



07-9902.18
 18 cm, 7"



07-9902.20
 20 cm, 8"



Tuchklemmen
Towel clamps
Pinces à champs
Pinzas de campo

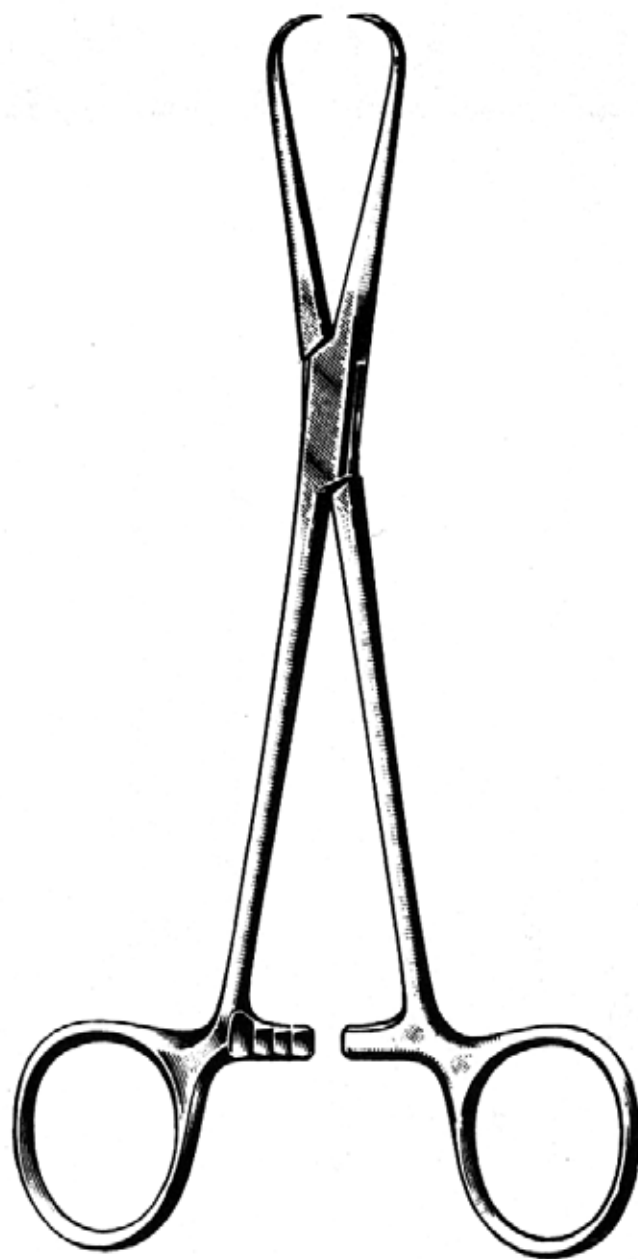

08



SCHAEDEL

08-9021.09

9 cm, 3 1/2"



JONES

08-9013.09

9 cm, 3 1/2"



JONES-CLIP

08-9015.09

9 cm, 3 1/2"



BACKHAUS

08-9065.09 9 cm, 3 1/2"

08-9065.11 11 cm, 4 1/2"

08-9065.13 13 cm, 5"

08-9065.15 15 cm, 5 3/4"

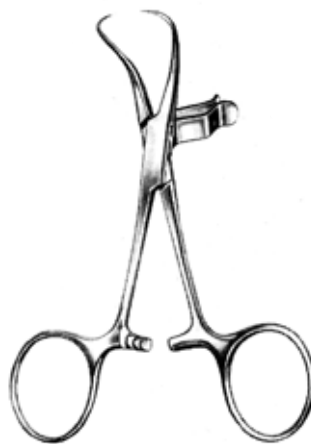

BACKHAUS-CLIP

08-9067.11

11 cm, 4 1/2"



ROEDER

08-9069.13

13 cm, 5"

Tuchklemmen
Towel clamps
Pinces à champs
Pinzas de campo

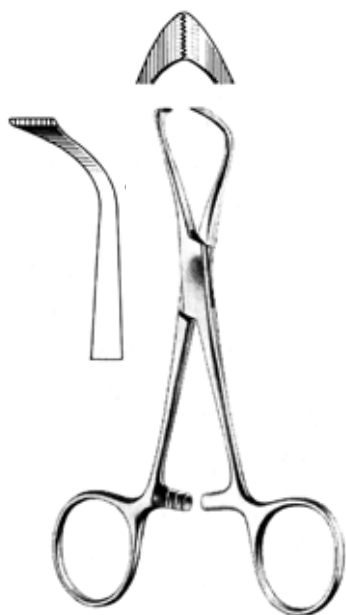

LORNA

08-9111.11 11 cm, 4 1/2"

08-9111.13 13 cm, 5"



BALL AND SOCKET

08-9121.13

13 cm, 5"



BERNHARD

08-9101.16

16,5 cm, 6 1/2"



MOYNIHAN

08-9103.19

19 cm, 7 1/2"



DOYEN

08-9043.18

18 cm, 7"

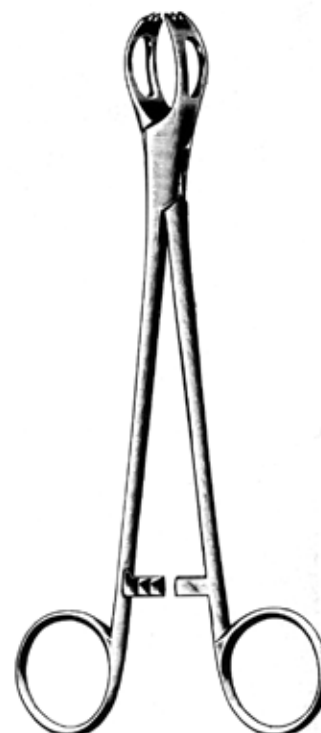

LANE

08-9050.20

20 cm, 8"

Tupferzangen
 Dressing Forceps
 Pincès à pansement
 Pinzas para tapones



GROSS-MAIER

08-9380.20 20 cm, 8"

08-9380.25 25 cm, 10"



GROSS-MAIER

08-9381.20 20 cm, 8"

08-9381.25 25 cm, 10"



ULRICH

08-9510.22 22 cm, 8 1/2"

08-9510.25 25 cm, 10"



ULRICH

08-9511.22 22 cm, 8 1/2"

08-9511.25 25 cm, 10"

08

Schwammzangen
Sponge Holding Forceps
Pinces porte-éponges
Pinzas porta-esponjas

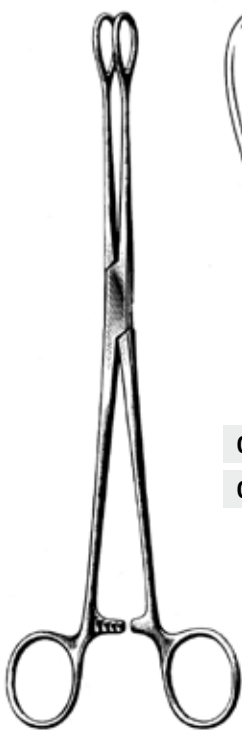

FOERSTER



08-9520.18 18 cm, 7" **08-9521.18**

08-9520.25 25 cm, 10" **08-9521.25**

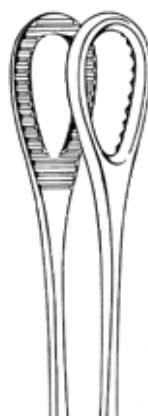
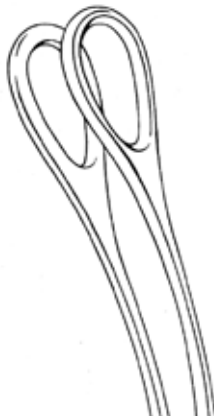

08-9522.18 18 cm, 7" **08-9523.18**

08-9522.20 20 cm, 8" **08-9523.20**

08-9522.25 25 cm, 10" **08-9523.25**

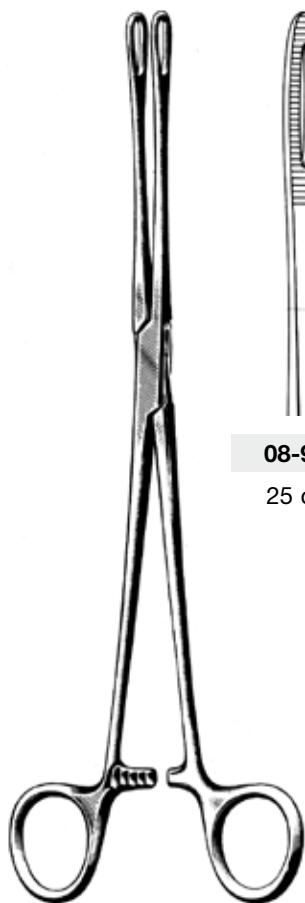
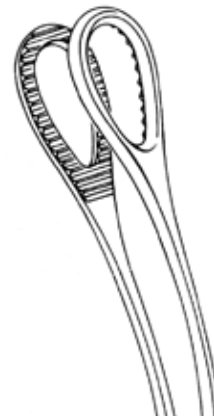

FOERSTER



08-9544.25

25 cm, 10"

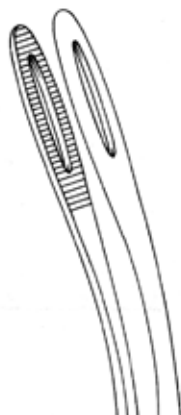

08-9545.25

25 cm, 10"



RAMPLEY

08-9546.25

25 cm, 10"

Schwammzangen
Sponge Holding Forceps
Pinces porte-éponges
Pinzas porta-esponjas



BRYANT

08-9547.13

13 cm, 5"



LISTER

08-9306.13

13 cm, 5"

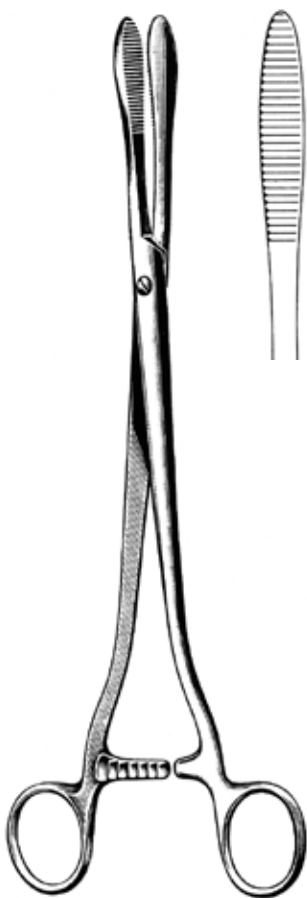

COLLIN

08-9500.25

25 cm, 10"

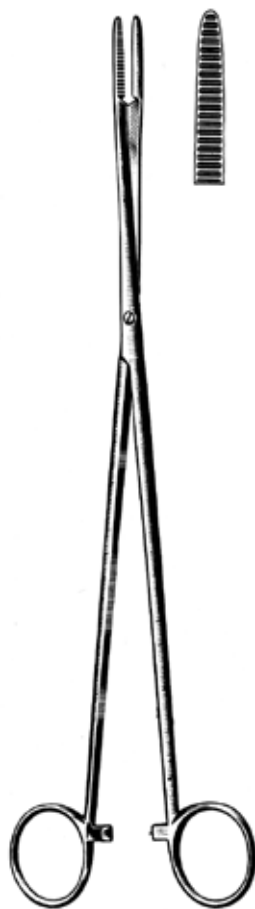

PELKMANN

08-9346.25

25 cm, 10"



CHERON

08-9503.25

25 cm, 10"

08

Schwammzangen
Sponge Holding Forceps
Pinces porte-éponges
Pinzas porta-esponjas

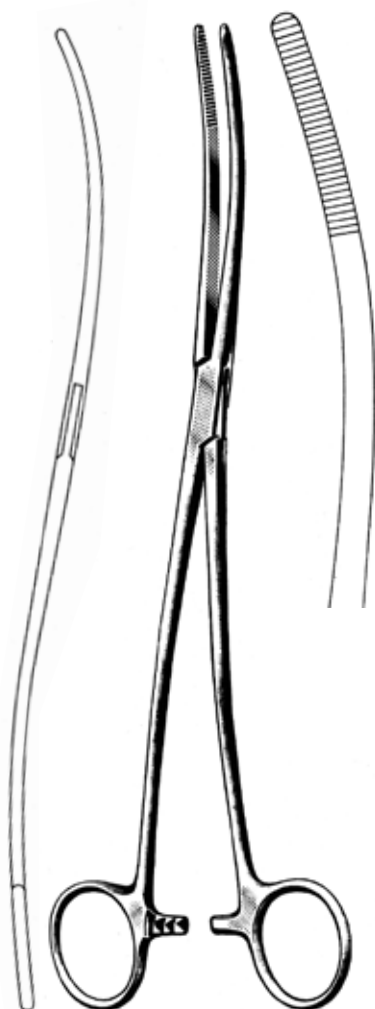

BOZEMANN

08-9570.26

26 cm, 10 1/4"

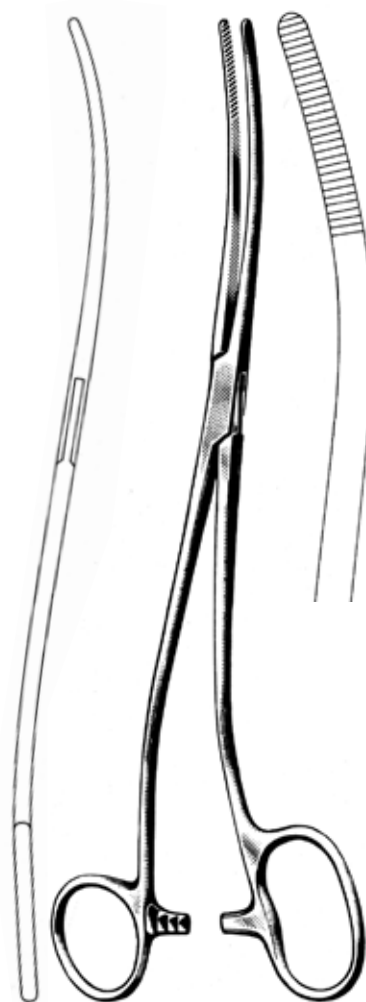

BOZEMANN-DOUGLAS

08-9579.26

26 cm, 10 1/4"

Schwammzangen
Sponge Holding Forceps
Pinces porte-éponges
Pinzas porta-esponjas

08



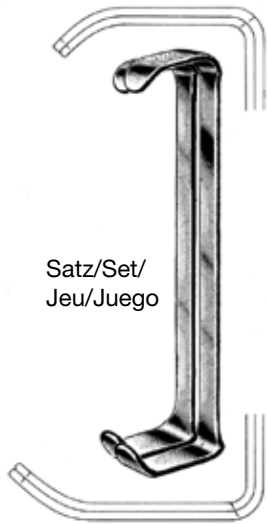

Satz/Set/
Jeu/Juego

FARABEUF

09-2543.00



Satz/Set/
Jeu/Juego

FARABEUF

09-2545.00

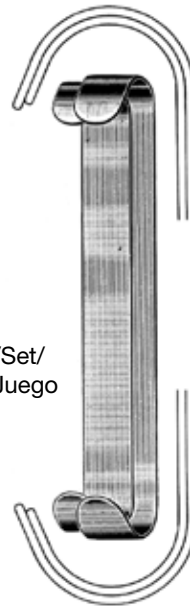

Satz/Set/
Jeu/Juego

PARKER

09-2563.00

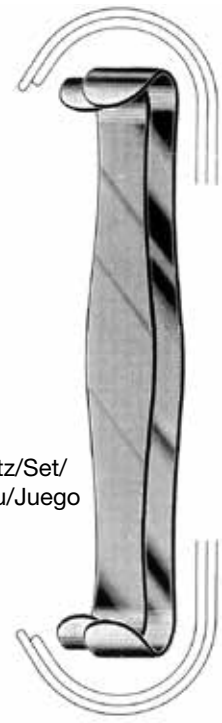

Satz/Set/
Jeu/Juego

PARKER

09-2568.00



Satz/Set/
Jeu/Juego

MATHIEU

09-2589.00

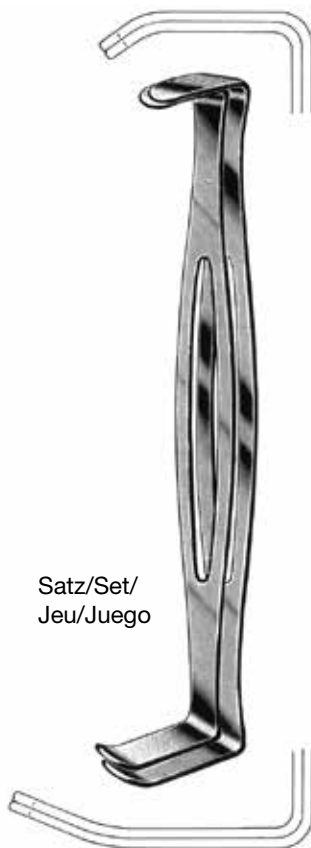

Satz/Set/
Jeu/Juego

PARKER-LANGENBECK

(US-ARMY)

09-2591.00

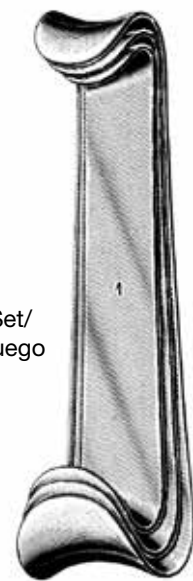

Satz/Set/
Jeu/Juego

ROUX

09-2516.00

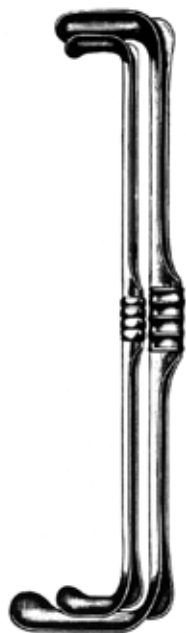

RICHARDSON-EASTMAN
 09-2075.00



RICHARDSON



09-2074.28
 28 x 20 mm



09-2074.36
 36 x 28 mm



09-2074.44
 44 x 38 mm



52 x 22 mm

RICHARDSON
 09-2074.52



65 x 50 mm

KELLY
 09-2076.65
 26 cm, 10 1/4"

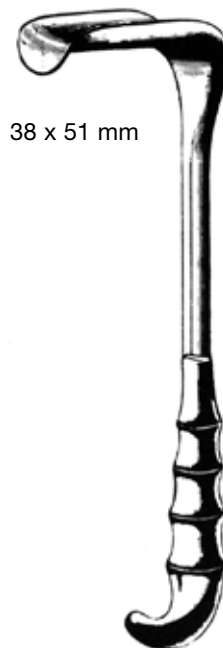

38 x 51 mm

KELLY
 09-2078.38
 26 cm, 10 1/4"



BABY-ROUX

09-2516.13

13 cm, 5"

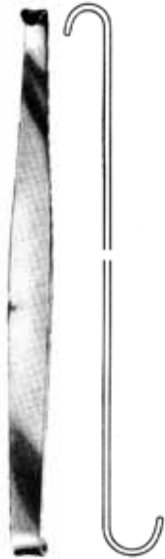

ROUX-MINI

09-2516.25

15 cm, 5 3/4"



CRILE

09-2517.11

11,5 cm, 4 1/2"



COLLIN-HARTMANN

09-2395.16

16 cm, 6 1/4"

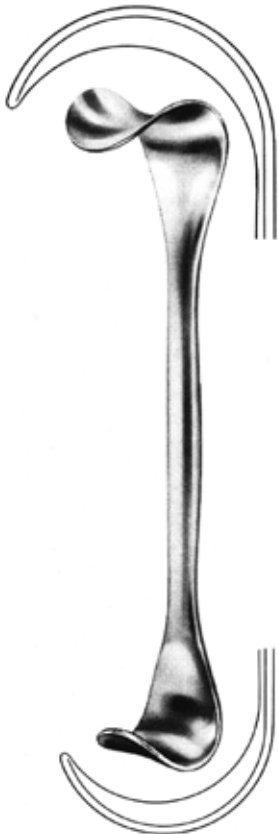

GOELET

09-2500.19

19 cm, 7 1/2"

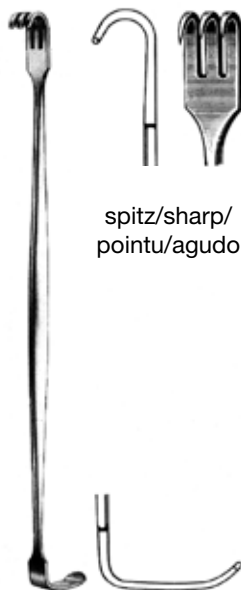

spitz/sharp/
pointu/agudo

SENN

09-0610.16

16 cm, 6 1/4"

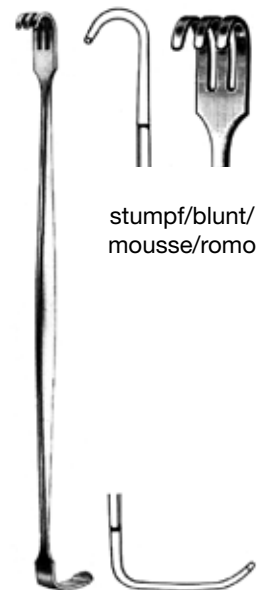

stumpf/blunt/
mousse/romo

SENN

09-0611.16

16 cm, 6 1/4"



09-2780.12 12 x 200 mm

09-2780.17 17 x 200 mm

09-2780.25 25 x 250 mm



09-2763.25 25 x 330 mm

09-2763.32 32 x 330 mm

09-2763.40 40 x 330 mm

09-2763.50 50 x 330 mm



HABERER

09-2766.18 17/25 x 200 mm

09-2766.30 25/30 x 250 mm

09-2766.37 37/45 x 300 mm



REVERDIN

09-2751.28

28 cm, 11"



HARRINGTON

09-2232.25 25 x 320 mm

09-2232.40 40 x 320 mm

09-2232.62 62 x 320 mm



DEAVER

09-2241.25 25 x 310 mm

09-2241.38 38 x 310 mm

09-2241.50 50 x 310 mm

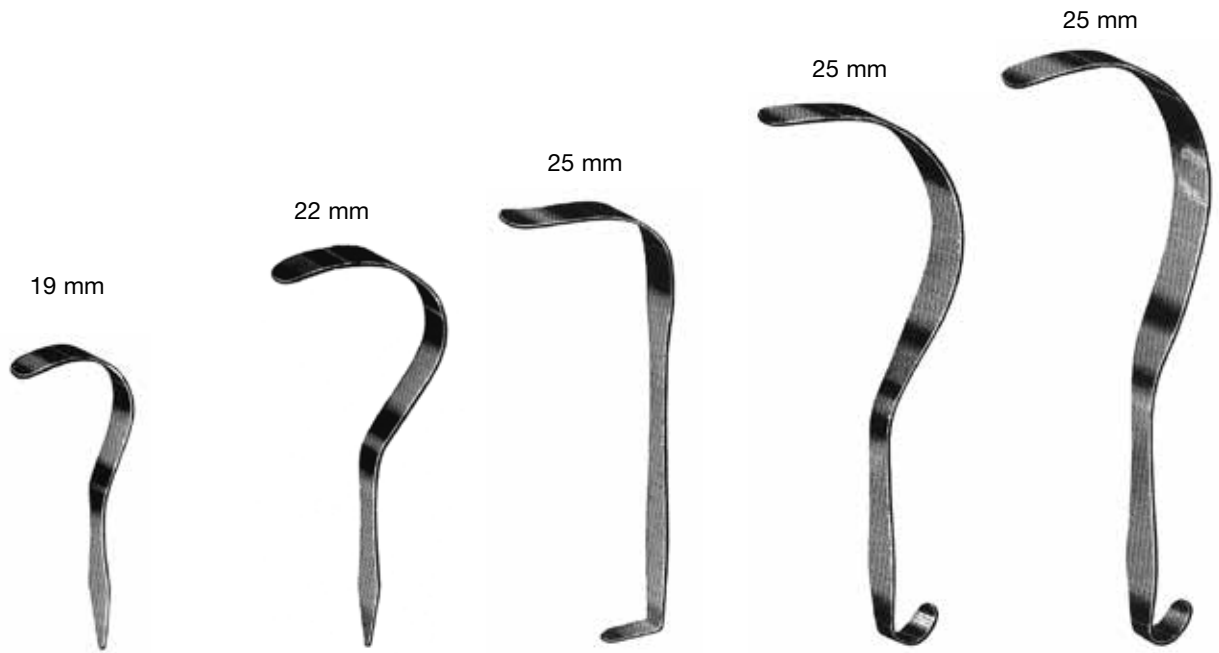

DEAVER
09-2240.01
18 cm, 7"

DEAVER
09-2240.02
21,5 cm, 8 1/4"

DEAVER
09-2240.03
23 cm, 9"

DEAVER
09-2240.04
30 cm, 12"

DEAVER
09-2240.05
33 cm, 13"



DEAVER
09-2240.06
36 cm, 14"

DEAVER
09-2240.07
30 cm, 12"

DEAVER
09-2240.08
30 cm, 12"

DEAVER
09-2240.09
30 cm, 12"

**Wundhaken
Retractors
Ecarteurs
Separadores**



09-0350.12

12 cm, 4 3/4"

spitz
sharp
pointu
agudo

Irishäkchen
Iris Hooks
Crochets à iris
Ganchos para iris

GRAEFE



09-0351.12

12 cm, 4 3/4"

stumpf
blunt
mousse
romo



09-0362.01

12 cm, 4 3/4"

Fig. 1

Irishäkchen
Iris Hooks
Crochets à iris
Ganchos para iris

GUTHRIE



09-0362.02

12 cm, 4 3/4"

Fig.2



FRAZIER

09-0136.13 13 cm, 5"

09-0136.18 18 cm, 7"



JOSEPH

09-0516.01

16 cm, 6 1/4"

2 mm

09-0516.02

16 cm, 6 1/4"

5 mm

09-0516.05

16 cm, 6 1/4"

7 mm

09-0516.07

16 cm, 6 1/4"

10 mm

09-0516.10

16 cm, 6 1/4"



09-0556.01

16 cm, 6 1/4"



09-0556.02

16 cm, 6 1/4"



09-0556.03

16 cm, 6 1/4"



09-0556.04

16 cm, 6 1/4"

spitz
sharp
pointu
agudo



09-0556.11

16 cm, 6 1/4"



09-0556.12

16 cm, 6 1/4"



09-0556.13

16 cm, 6 1/4"



09-0556.14

16 cm, 6 1/4"

stumpf
blunt
mousse
romo



09-0586.02

16 cm, 6 1/4"



09-0586.03

16 cm, 6 1/4"



09-0586.04

16 cm, 6 1/4"

spitz
sharp
pointu
agudo



09-0586.12

16 cm, 6 1/4"



09-0586.13

16 cm, 6 1/4"



09-0586.14

16 cm, 6 1/4"

stumpf
blunt
mousse
romo

Wundhaken
Retractors
Ecarteurs
Separadores

12 mm



09-0856.12

16 cm, 6 1/4"

14 mm



09-0856.14

16 cm, 6 1/4"

16 mm



09-0856.16

16 cm, 6 1/4"

18 mm



09-0856.18

16 cm, 6 1/4"

DESMARRES

8 mm



09-0940.08

20 cm, 8"

10 mm



09-0940.10

20 cm, 8"

12 mm



09-0940.12

20 cm, 8"

14 mm



09-0940.14

20 cm, 8"

16 mm



09-0940.16

20 cm, 8"

18 mm



09-0940.18

20 cm, 8"

CUSHING



CUSHING

09-0850.20

20 cm, 8"



CUSHING

09-0850.21

21,5 cm, 8 1/4"

09

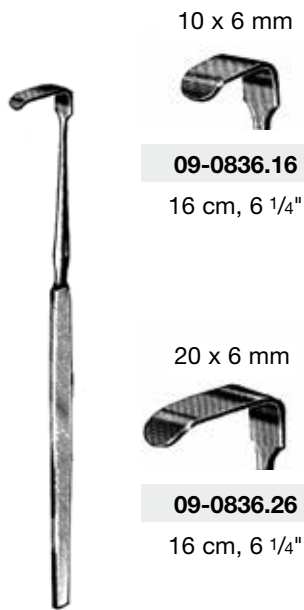

10 x 6 mm

09-0836.16

16 cm, 6 1/4"



20 x 6 mm

09-0836.26

16 cm, 6 1/4"

SENN-GREEN



18 x 7 mm

09-1071.01

18 cm, 7"

7 x 4 mm

09-1071.04

18 cm, 7"

16 x 5 mm

09-1071.02

18 cm, 7"

10 x 3 mm

09-1071.05

18 cm, 7"

7 x 4 mm

09-1071.03

18 cm, 7"

7 x 9 mm

09-1071.06

18 cm, 7"

MEYERDING

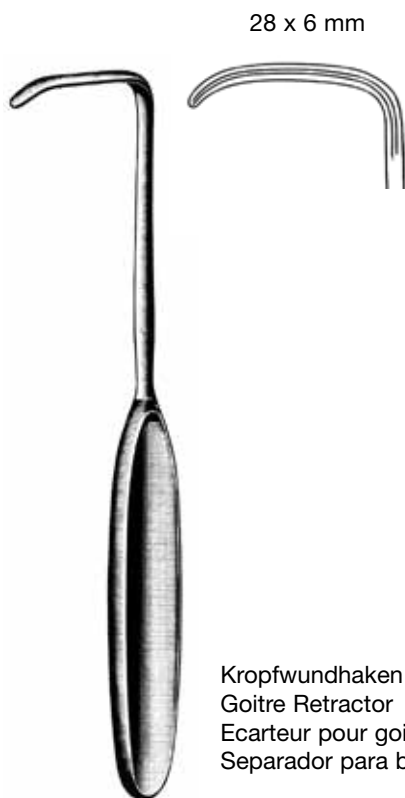

28 x 6 mm

LAHEY

09-1239.28

19 cm, 7 1/2"

Kropfwundhaken
Goitre Retractor
Ecarteur pour goitre
Separador para bocio



12 x 14 mm

LITTLE

09-1242.12

20 cm, 8"

Wundhaken
Retractors
Ecarteurs
Separadores



09-0591.02

11,5 cm, 4 1/2"



09-0591.12

11,5 cm, 4 1/2"



09-0591.03

11,5 cm, 4 1/2"



09-0591.13

11,5 cm, 4 1/2"



09-0591.04

11,5 cm, 4 1/2"



09-0591.14

11,5 cm, 4 1/2"



09-0591.06

11,5 cm, 4 1/2"



09-0591.16

11,5 cm, 4 1/2"



VOLKMANN



09-1061.01

21,5 cm, 8 1/4"



09-1061.11

21,5 cm, 8 1/4"



09-1061.02

21,5 cm, 8 1/4"



09-1061.12

21,5 cm, 8 1/4"



09-1061.03

21,5 cm, 8 1/4"



09-1061.13

21,5 cm, 8 1/4"



09-1061.04

21,5 cm, 8 1/4"



09-1061.14

21,5 cm, 8 1/4"



09-1061.06

21,5 cm, 8 1/4"



09-1061.16

21,5 cm, 8 1/4"



VOLKMANN



09-1172.01
30 x 11 mm



09-1181.01
30 x 11 mm



09-1172.02
30 x 14 mm



09-1181.02
30 x 14 mm



09-1172.03
30 x 16 mm



09-1181.03
30 x 16 mm



09-1172.04
40 x 11 mm



09-1181.04
40 x 11 mm

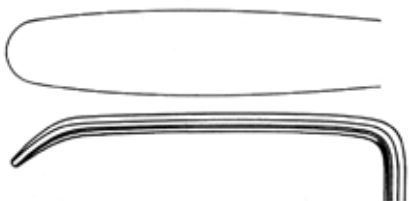

09-1172.05
50 x 11 mm

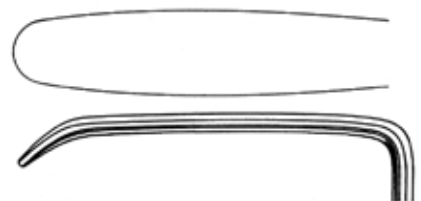

09-1181.05
50 x 11 mm



LANGENBECK
22 cm, 8 1/2"



LANGENBECK
21 cm, 8 1/4"

09

Wundhaken
Retractors
Ecarteurs
Separadores



LANGENBECK

21 cm, 8 1/4"



09-1261.10

35 x 10 mm



09-1261.07

35 x 7 mm



09-1261.20

60 x 20 mm



09-1261.15

35 x 15 mm

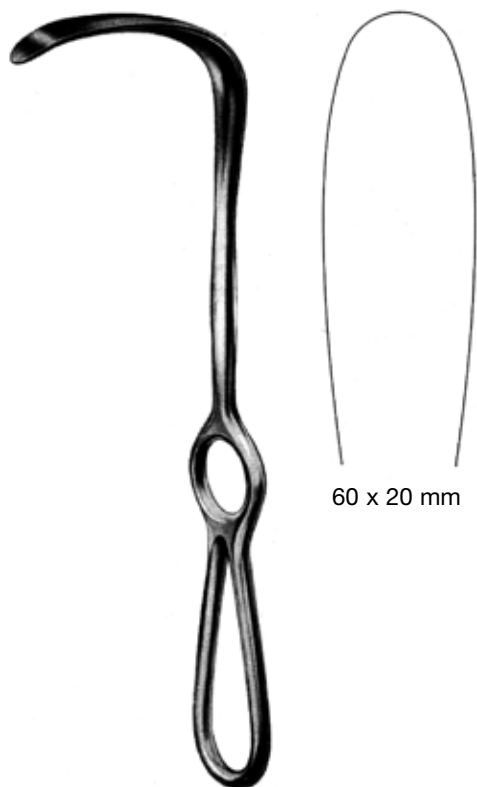

60 x 20 mm

LANGENBECK

09-1191.60

21 cm, 8 1/4"

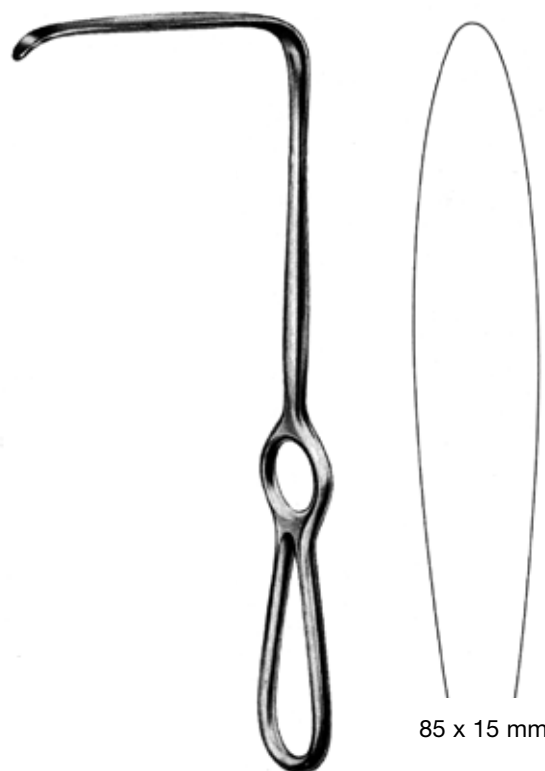

85 x 15 mm

LANGENBECK

09-1221.85

21 cm, 8 1/4"



23 cm, 9"



09-1253.40
40 x 18 mm



09-1253.57
57 x 25 mm

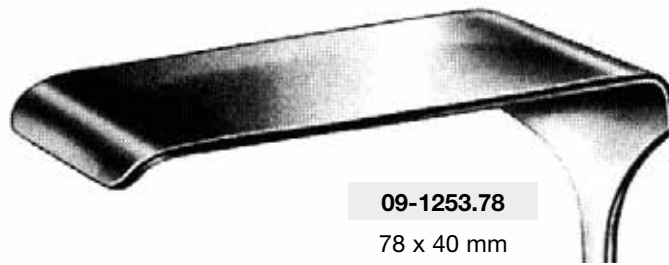

09-1253.78
78 x 40 mm



KOCHER

19 cm, 7 1/2"

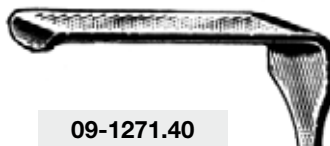

09-1271.40
40 x 12 mm

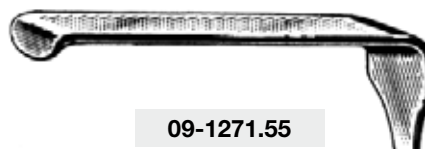

09-1271.55
55 x 11 mm



KOCHER

19 cm, 7 1/2"



09-1273.19
19 x 12 mm



09-1273.21
21 x 14 mm

Wundhaken
Retractors
Ecarteurs
Separadores



09-1275.10 40 x 10 mm

09-1275.15 40 x 15 mm

09-1275.20 40 x 20 mm

KOCHER

22 cm, 8 1/2"



GREEN

09-2050.22

22 cm, 8 1/2"

Schilddrüsenhaken
Thyroid Gland Retractor
Ecarteur pour la thyroïde
Separador para glándula tiroidea



MIDDELDORPF

14 x 17 mm



09-2010.14

21,5 cm, 8 1/4"

20 x 22 mm



09-2010.20

22 cm, 8 1/2"

26 x 30 mm



09-2010.26

23,5 cm, 9 1/4"



09-1155.40

40 x 40 mm



09-1155.50

45 x 50 mm



OLLIER

09-1145.08

22,5 cm, 8 3/4"



ISRAEL

25 cm, 10"

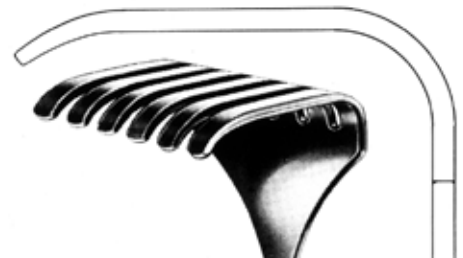

09-1155.60

50 x 60 mm

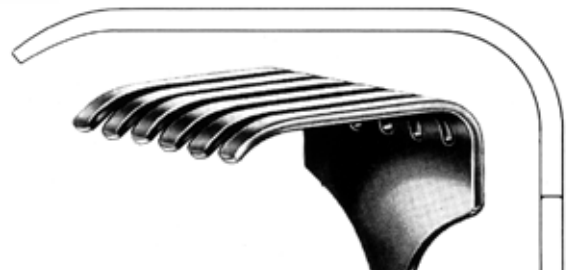

09-1155.70

70 x 70 mm

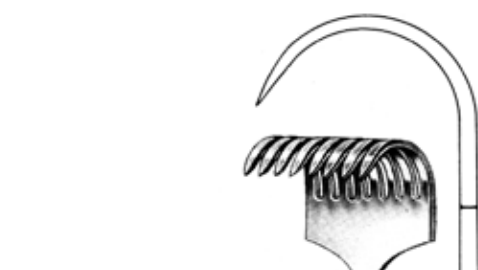

09-1124.08

40 x 30 mm

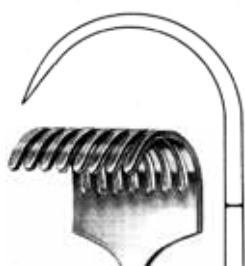

09-1124.18

40 x 30 mm



KOERTE

23,5 cm, 9 1/4"



FRITSCH

24 cm, 9 1/2"



09-2324.40 45 x 40 mm

09-2324.50 45 x 50 mm

09-2324.60 45 x 60 mm

09-2324.70 45 x 70 mm



KOCHER

- 09-2345.45 80 x 45 mm
- 09-2345.55 80 x 55 mm
- 09-2345.65 80 x 65 mm

25 cm, 10"

70 x 25 mm



KOCHER

09-2342.25
 22,5 cm, 8 3/4"

50 x 85 mm



DOYEN

09-2335.85
 25 cm, 10"

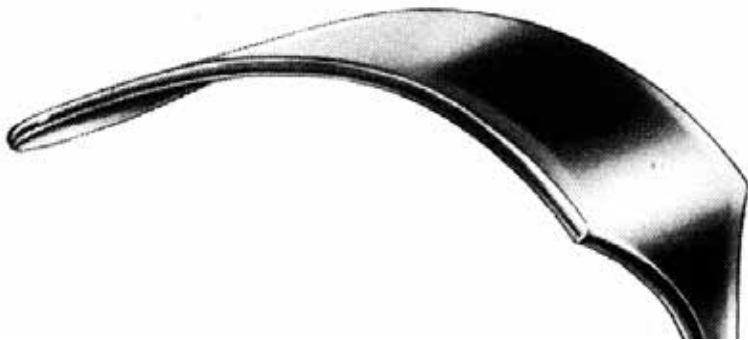

09-2361.35

95 x 35 mm



MIKULICZ

26 cm, 10 1/4"

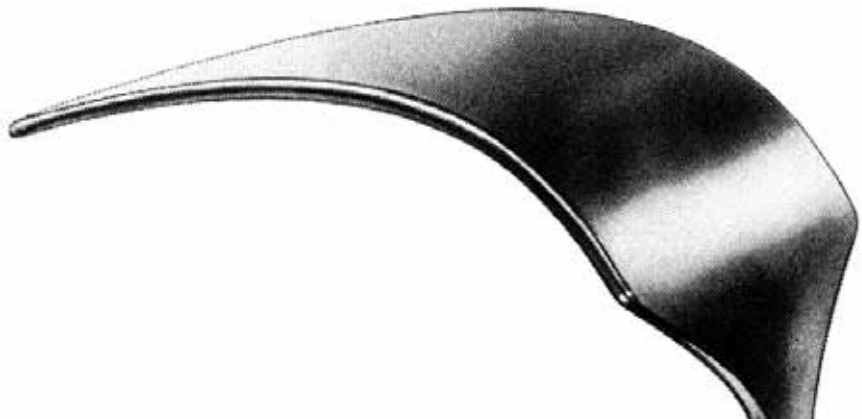

09-2361.50 120 x 50 mm

09-2361.55 150 x 50 mm



09-2361.60

90 x 50 mm

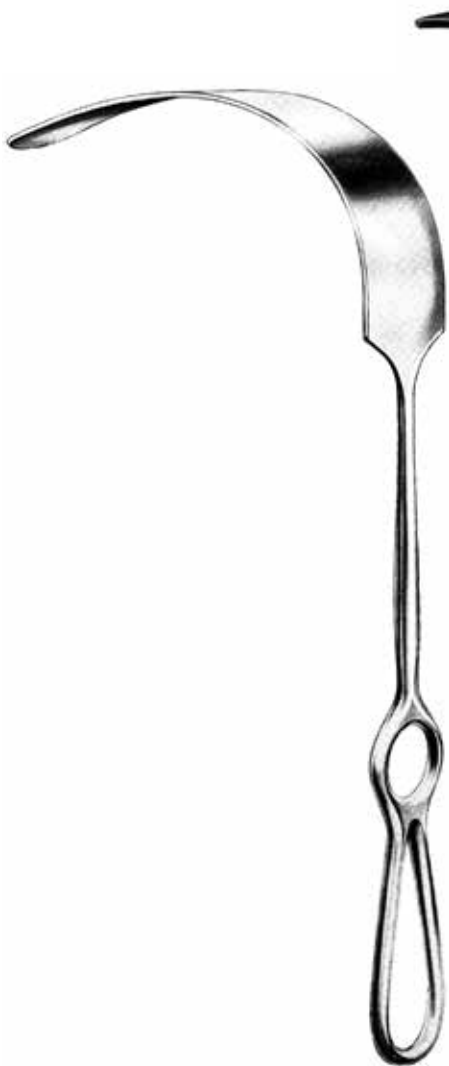

KELLY

09-2371.38 160 x 38 mm

09-2371.57 160 x 57 mm

27 cm, 10 1/2"

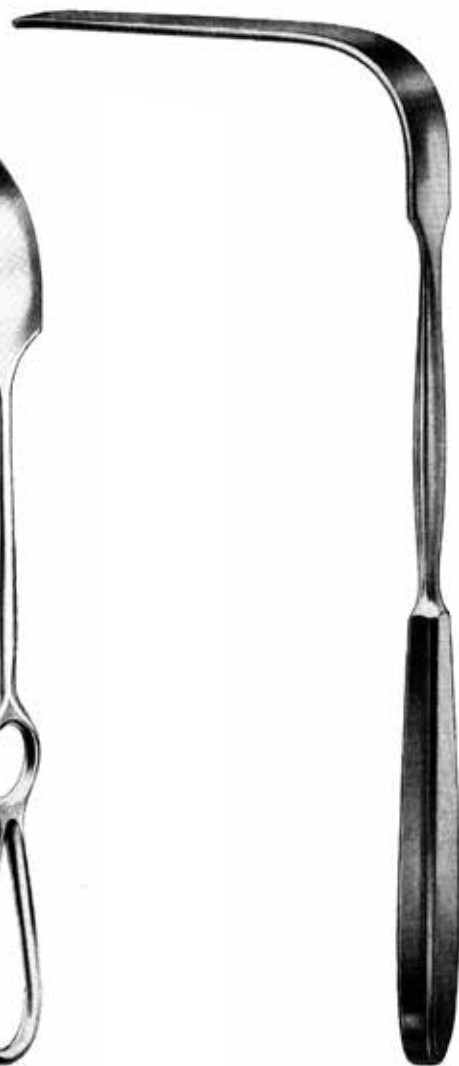

SIMON

09-2268.22 115 x 22 mm

09-2268.27 117 x 27 mm

28 cm, 11"

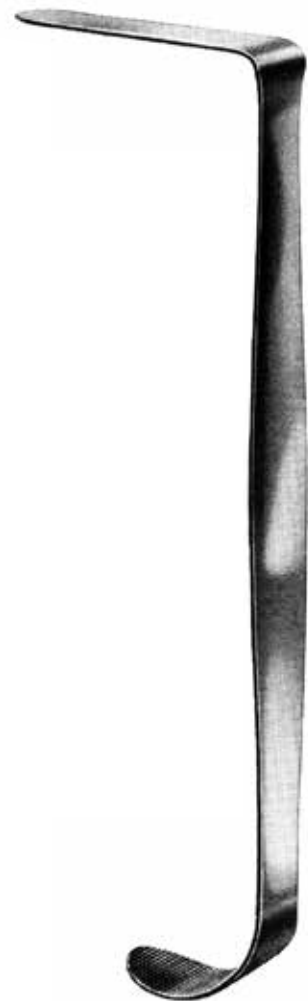

HEANEY

09-2269.45 45 x 25 mm

09-2269.73 73 x 28 mm

09-2269.82 82 x 28 mm

27 cm, 10 1/2"



CORYLLOS

09-2252.22 82 x 22 mm

09-2252.38 115 x 38 mm

09-2252.45 108 x 45 mm

09-2252.65 115 x 65 mm

22,5 cm, 8 3/4"



SAUERBRUCH

09-2255.45 45 x 15 mm

09-2255.60 60 x 23 mm

09-2255.75 75 x 20 mm

25 cm, 10"



125 x 37 mm

SAUERBRUCH

09-2255.25

25 cm, 10"



Scapula-Haken
Scapula Retractor
Ecarteur à omoplate
Separador para escápula

DAVIDSON

09-2061.50

75 x 50 mm



Scapula-Haken
Scapula Retractor
Ecarteur à omoplate
Separador para escápula

DAVIDSON

09-2061.90

75 x 90 mm

Wundspreizer, selbsthaltend
Self-retaining Retractors
Ecarteurs autostatiques
Separadores autostáticos

stumpf
 blunt
 mousse
 romo

scharf
 sharp
 pointu
 agudo



FINSEN

09-5134.34

09-5134.44

7 cm, 2 3/4"



ALM

09-5107.04

09-5107.14

7 cm, 2 3/4"

4 x 4



ALM

09-5110.04

09-5110.14

10 cm, 3 3/4"



JANSEN

09-5312.03

09-5312.13

10 cm, 3 3/4"



KAUPP

09-5130.04

09-5130.14

10 cm, 3 3/4"

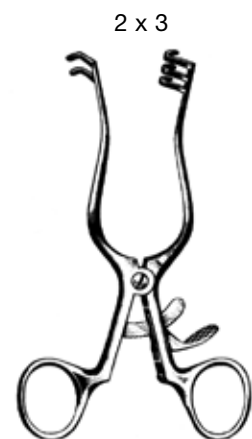

WEITLANER

09-5211.23

09-5211.43

11,5 cm, 4 1/2"

09

Wundspreizer, selbsthaltend
Self-retaining Retractors
Ecarteurs autostatiques
Separadores autostáticos

stumpf
blunt
mousse
romo

scharf
sharp
pointu
agudo

3 x 4

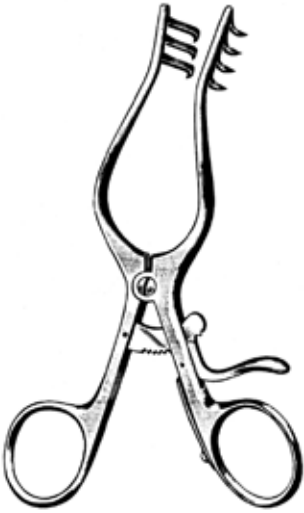

WEITLANER-WULLSTEIN

09-5213.34 

09-5213.44 

13 cm, 5"



PLESTER

09-5363.11

11 cm, 4 1/4"



PLESTER

09-5364.11

11 cm, 4 1/4"

3 x 4



WEITLANER

09-5214.34 

09-5214.44 

14 cm, 5 1/2"

3 x 4



WEITLANER

09-5216.34 

09-5216.44 

16 cm, 6 1/4"

3 x 4



WEITLANER

09-5220.34 

09-5220.44 

20 cm, 8"

09

Wundspreizer, selbsthaltend
Self-retaining Retractors
Ecarteurs autostatiques
Separadores autostáticos

stumpf
 blunt
 mousse
 romo

scharf
 sharp
 pointu
 agudo



3 x 4



4 x 4

ADSON

09-5620.44 

09-5620.84 

19 cm, 7 1/2"



ADSON

09-5626.44 

09-5626.84 

26,5 cm, 10 1/2"



5 x 4

ADSON

09-5693.45

32 cm, 12 3/4"

09

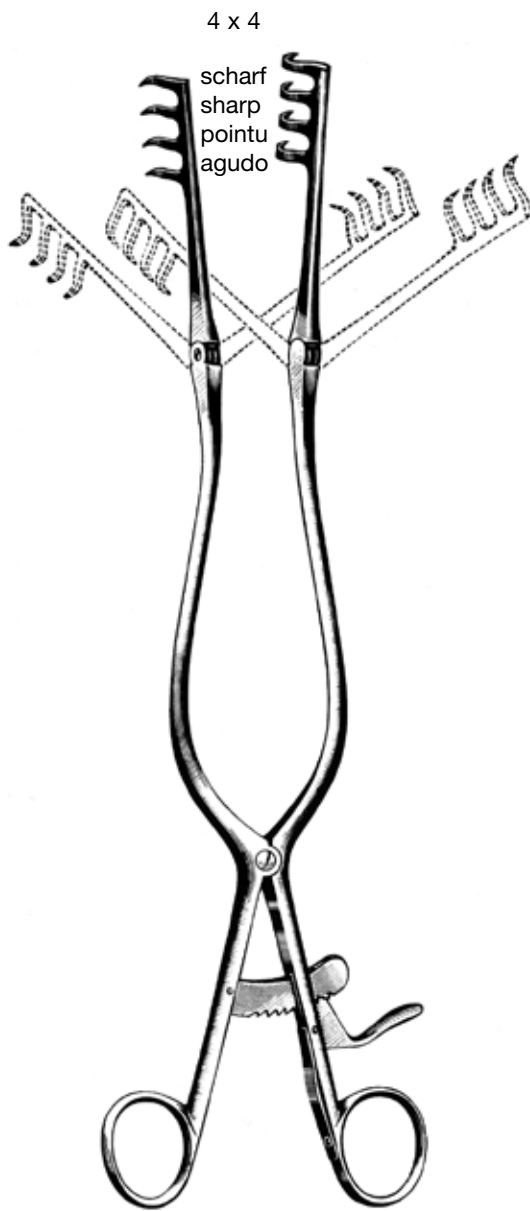

BECKMANN

09-5681.44

31 cm, 12 1/2"



BECKMANN-EATON

09-5702.77

32 cm, 12 3/4"

Wundspreizer, selbsthaltend
Self-retaining Retractors
Ecarteurs autostatiques
Separadores autostáticos

stumpf
blunt
mousse
romo

scharf
sharp
pointu
agudo

09



MOLLISON

09-5445.44

15 cm, 5 3/4"



DARLING

09-5854.18

18 cm, 7"



DARLING

09-5855.18

18 cm, 7"

Wundspreizer, selbsthaltend
Self-retaining Retractors
Ecarteurs autostatiques
Separadores autostáticos

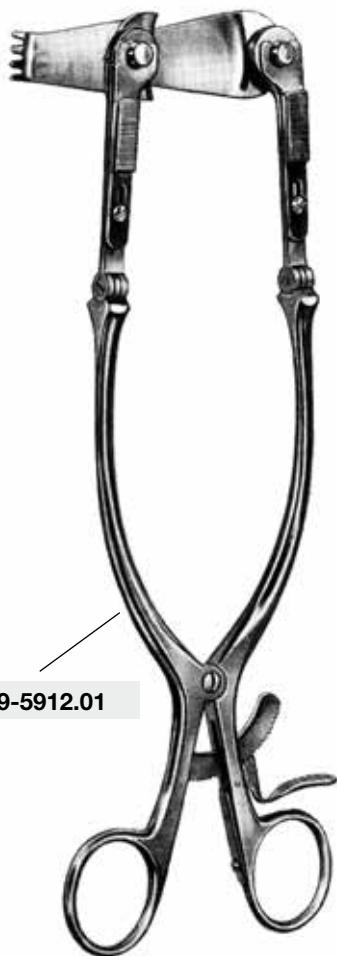

09-5912.01

CLOWARD

25 cm, 10"



09-5912.40

40 mm



09-5912.45

45 mm



09-5912.50

50 mm



09-5912.55

55 mm



09-5912.60

60 mm

09-5912.00

Satz / Set / Jeu / Juego

09-5912.01 - 09-5912.60

09-5912.95

Satz / Set / Jeu / Juego

09-5912.40 - 09-5912.60



09-5910.01

CLOWARD

17 cm, 6 3/4"



09-5910.40

40 mm



09-5910.45

45 mm



09-5910.50

50 mm



09-5910.55

55 mm



09-5910.60

60 mm

09-5910.00

Satz / Set / Jeu / Juego

09-5910.01 - 09-5910.60

09-5910.95

Satz / Set / Jeu / Juego

09-5910.40 - 09-5910.60

Vulvaspreizer
Vaginal Retractors
Ecarteurs vulvaires
Separadores para vulva



GELPI

09-6830.09 9 cm, 3 1/2"

09-6830.14 14 cm, 5 1/2"

09-6830.16 16 cm, 6 1/4"

09-6830.18 18 cm, 7"



GELPI

09-6832.18

18 cm, 7"



RIGBY

09-6831.18

18 cm, 7"

Bauchdeckenhalter
Abdominal Retractors
Ecarteurs abdominaux
Separadores abdominales

38 x 60 mm

38 x 60 mm

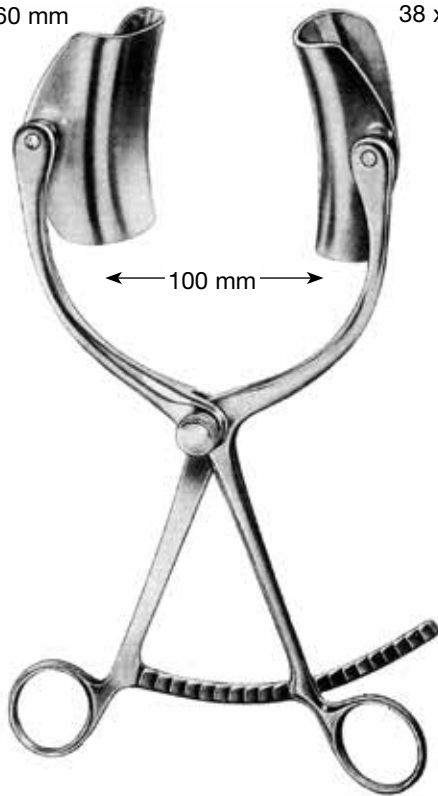

COLLIN

09-6040.10

38 x 60 mm

38 x 60 mm

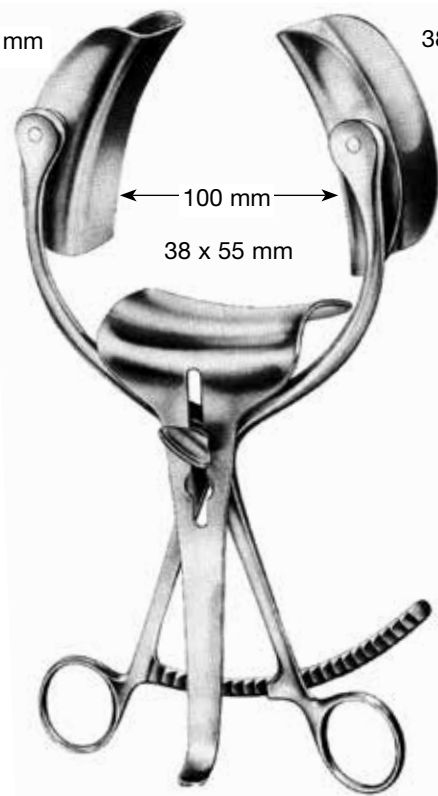

COLLIN

09-6041.60

38 x 60 mm

38 x 60 mm

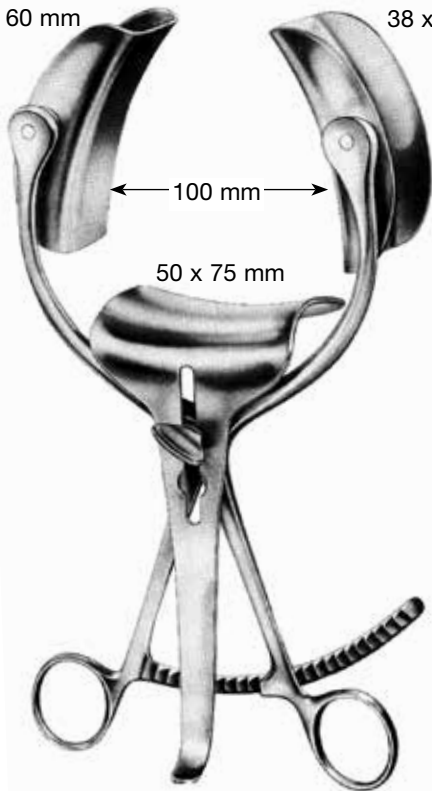

COLLIN

09-6041.80

60 x 80 mm

60 x 80 mm

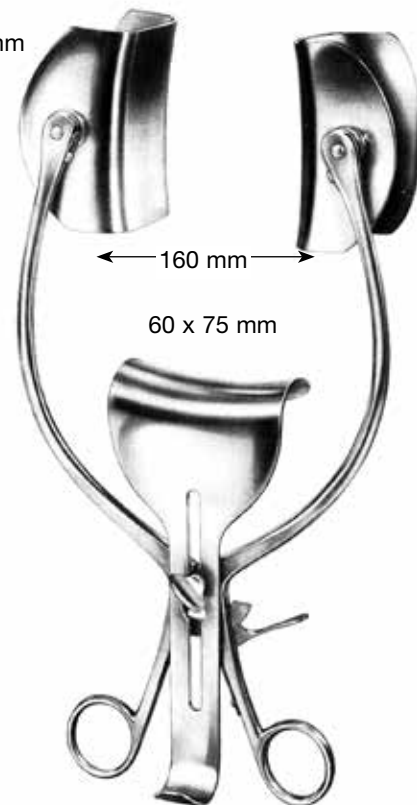

COLLIN-LOKTITE

09-6050.10

09

Bauchdeckenhalter
Abdominal Retractors
Ecarteurs abdominaux
Separadores abdominales

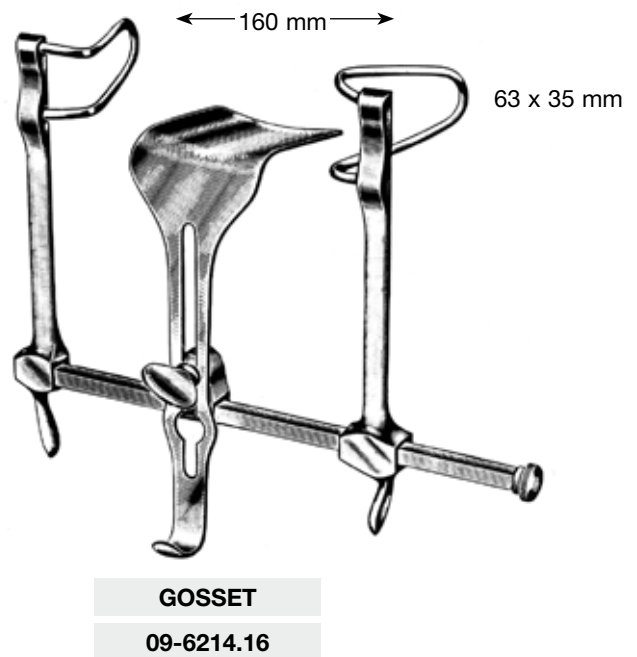
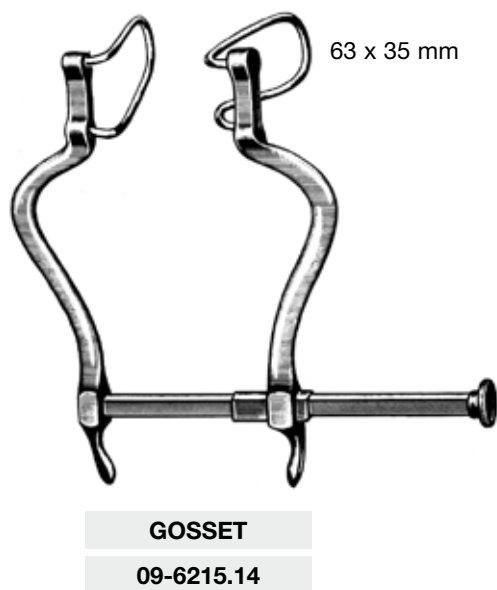
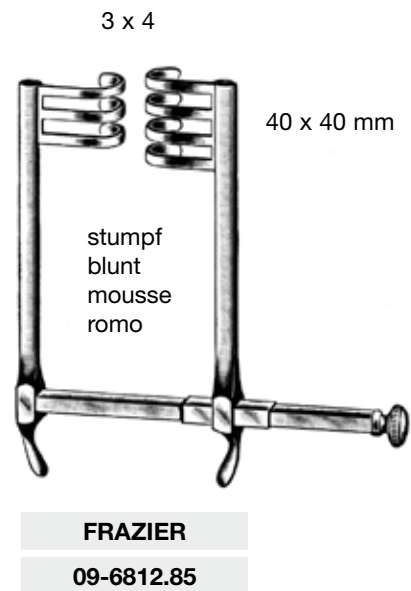
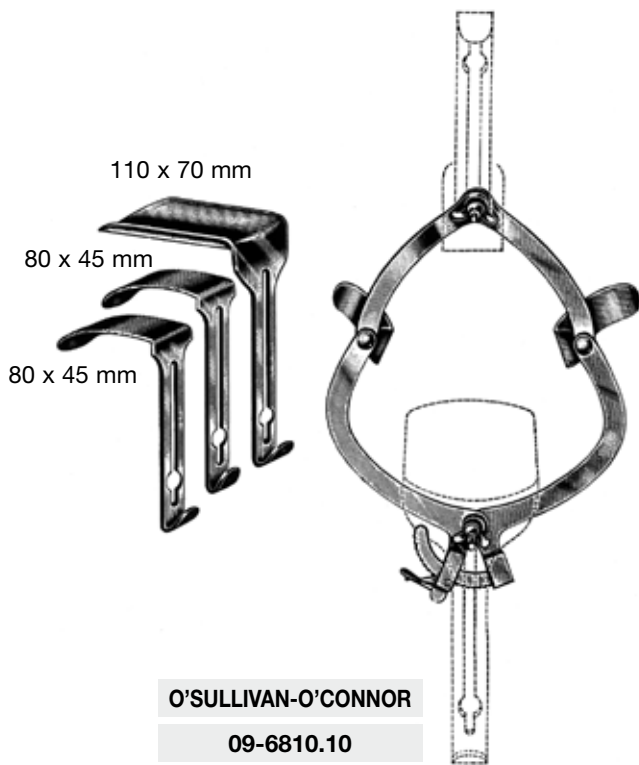

Bauchdeckenhalter
Abdominal Retractors
Ecarteurs abdominaux
Separadores abdominales

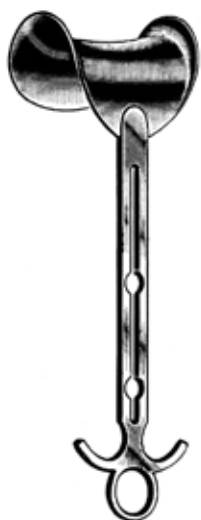

BALFOUR

09-6230.45 45 x 80 mm

09-6230.70 70 x 85 mm

09-6230.80 80 x 90 mm

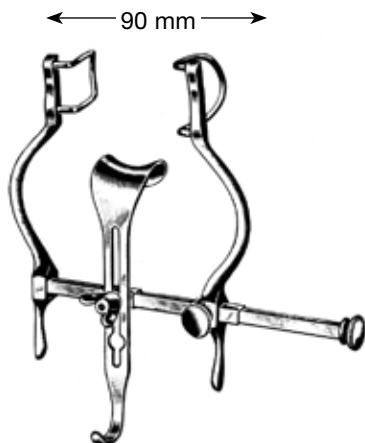

BALFOUR-BABY

09-6232.09

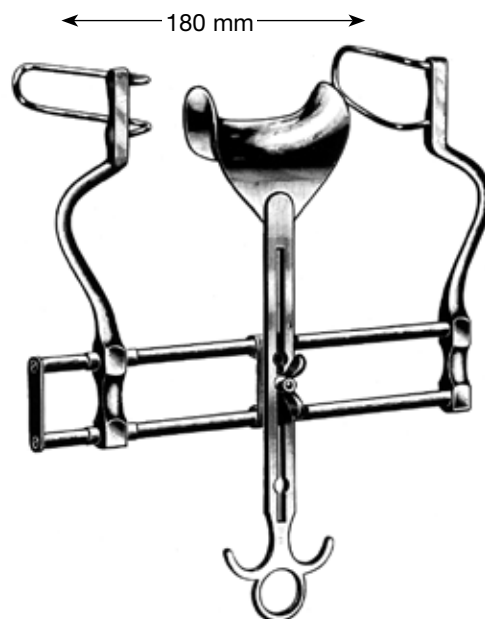

BALFOUR

09-6240.18



BALFOUR

09-6244.20

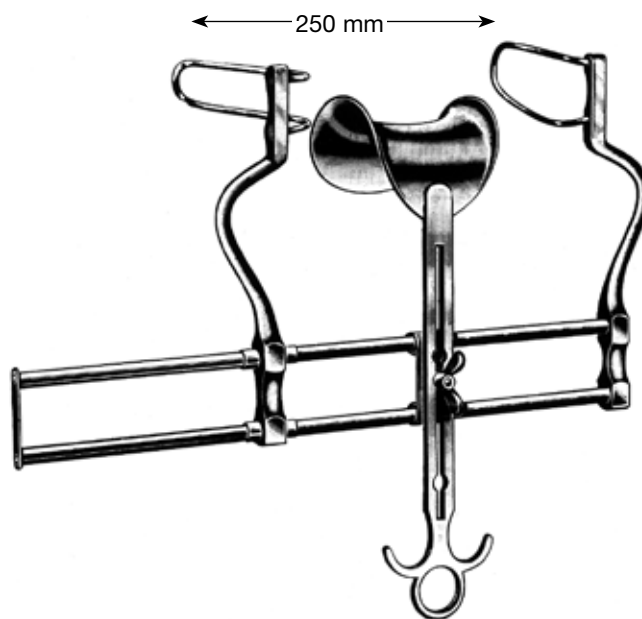

BALFOUR

09-6244.25

09

Bauchdeckenhalter
Abdominal Retractors
Ecarteurs abdominaux
Separadores abdominales



KIRSCHNER

09-6330.10

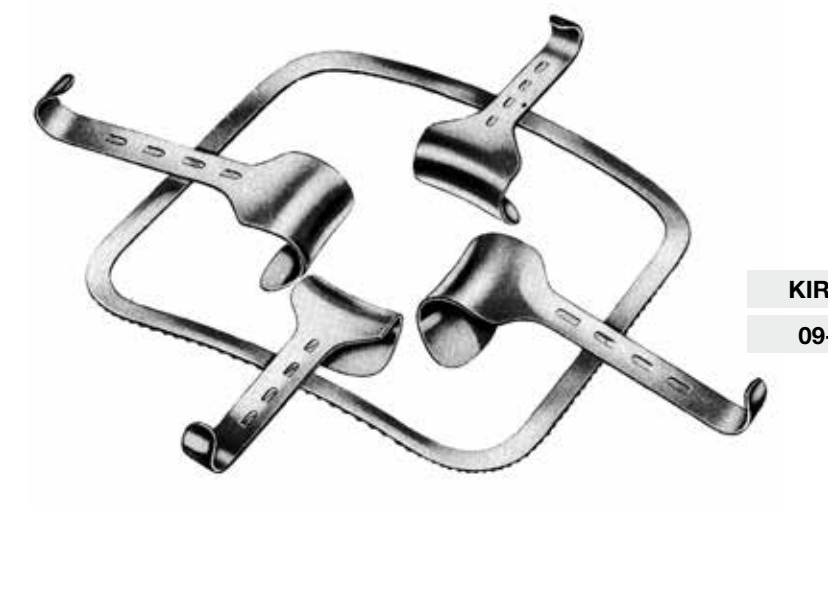

KIRSCHNER

09-6320.10



KIRSCHNER

09-6324.10

105 x 35 mm



KIRSCHNER

09-6324.98

98 x 50 mm



KIRSCHNER

09-6320.55

40 x 55 mm



KIRSCHNER

09-6320.65

50 x 65 mm



Muskelhaken
Muscle Hooks
Ecarteurs musculaires
Ganchos musculares

09-7924.10

10,5 cm, 4 1/4"



Muskelhaken
Muscle Hooks
Ecarteurs musculaires
Ganchos musculares

09-7915.03

09



Sonden
Probes, Directors
Stylets, sondes
Estiletos, sondas

Ø 2 mm



10-0010.11 11,5 cm, 4 1/2"

10-0010.13 13 cm, 5"

10-0010.14 14,5 cm, 5 1/2"

10-0010.16 16 cm, 6 1/4"

10-0010.18 18 cm, 7"

10-0010.20 20 cm, 8"

10-0010.25 25 cm, 10"

Ø 1 mm



10-0052.11 11,5 cm, 4 1/2"

10-0052.13 13 cm, 5"

10-0052.14 14,5 cm, 5 1/2"

10-0052.16 16 cm, 6 1/4"

10-0052.18 18 cm, 7"

10-0052.20 20 cm, 8"

10-0052.25 25 cm, 10"

Ø 2 mm



10-0053.11 11,5 cm, 4 1/2"

10-0053.13 13 cm, 5"

10-0053.14 14,5 cm, 5 1/2"

10-0053.16 16 cm, 6 1/4"

10-0053.18 18 cm, 7"

10-0053.20 20 cm, 8"

10-0053.25 25 cm, 10"



10-0065.14 14,5 cm, 5 1/2"

10-0065.16 16 cm, 6 1/4"



10-0100.13 13 cm, 5"

10-0100.14 14,5 cm, 5 1/2"

10-0100.16 16 cm, 6 1/4"

10-0100.18 18 cm, 7"

10-0100.20 20 cm, 8"



10-0110.13 13 cm, 5"

10-0110.14 14,5 cm, 5 1/2"

10-0110.16 16 cm, 6 1/4"

10-0110.18 18 cm, 7"

10

Sonden
Probes, Directors
Stylets, sondes
Estiletos, sondas



DOYEN
10-0101.14
 14,5 cm, 5 1/2"



silber
 silver
 argent
 plata
STACKE
10-0082.10
 10 cm, 4 1/4"



10-0502.13 13 cm, 5"
10-0502.14 14 cm, 5 1/2"

Varizenbesteck
 Varicose vein probe set
 Trousse à varices
 Juego para várices

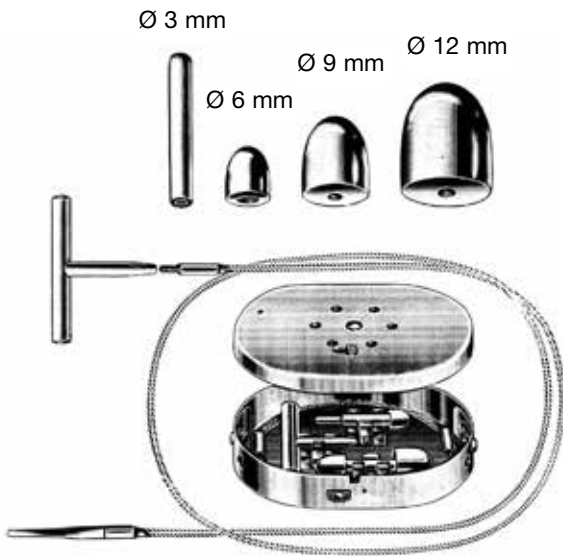

NABATOFF
10-5650.00
 Satz / Set / Jeu / Juego



10-5650.03
 Ø 3 mm



10-5650.06
 Ø 6 mm



10-5650.09
 Ø 9 mm



10-5650.12
 Ø 12 mm



10-5650.15
 Ø 15 mm



10-5650.02
 Ø 3 mm

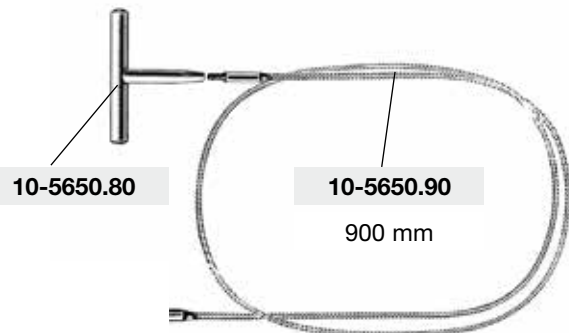

Endarterektomiestripper
Endarterectomy Stripper
Sondes à endartérectomie
Sondas para endarterectomía



4 mm



6 mm



7 mm



8 mm



10 mm



12 mm



14 mm

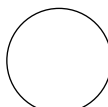

10-5681.04

4 mm

10-5681.06

6 mm

10-5681.07

7 mm

10-5681.08

8 mm

10-5681.10

10 mm

10-5681.12

12 mm

10-5681.14

14 mm

10-5682.12

für / for / pour / para

10.5681.04 - 10.5681.14

10

Watteträger
Cotton Applicators
Porte-cotons
Porta-algodones

Ø 1,2 mm



FARREL

10-0712.12	12 cm, 4 3/4"
10-0712.14	14 cm, 5 1/2"
10-0712.16	16 cm, 5 1/2"
10-0712.18	18 cm, 7"
10-0712.23	23 cm, 9"

Ø 1,2 mm



FARREL

10-0732.12	12 cm, 4 3/4"
10-0732.14	14 cm, 5 1/2"
10-0732.16	16 cm, 5 1/2"
10-0732.18	18 cm, 7"
10-0732.23	23 cm, 9"

Ø 1,5 mm



10-0815.12	12 cm, 4 3/4"
10-0815.14	14 cm, 5 1/2"
10-0815.16	16 cm, 5 1/2"
10-0815.18	18 cm, 7"

Ø 1,5 mm



10-0816.12	12 cm, 4 3/4"
10-0816.14	14 cm, 5 1/2"
10-0816.16	16 cm, 5 1/2"
10-0816.18	18 cm, 7"



UCKERMANN

10-0642.15	15 cm, 5 3/4"
-------------------	---------------



JOBSON-HORNE

10-0828.12	12 cm, 4 3/4"
10-0828.18	18 cm, 7"



10-1150.45



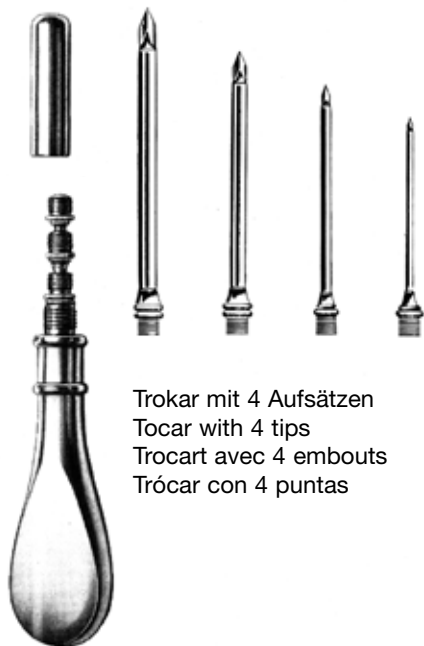

Trokar mit 4 Aufsätzen
Tocar with 4 tips
Trocart avec 4 embouts
Trócar con 4 puntas

UNIVERSAL

11-3004.00



11-2131.30 3,0 mm

11-2130.40 4,0 mm

11-2130.50 5,0 mm

PIERCE

17 cm, 6 3/4"



11-3010.30 3,0 mm

11-3010.35 3,5 mm

11-3010.40 4,0 mm

11-3010.45 4,5 mm

11-3010.50 5,0 mm

11-3010.55 5,5 mm

11-3010.60 6,0 mm

18 cm, 7"



11-3012.30 3,0 mm

11-3012.35 3,5 mm

11-3012.40 4,0 mm

11-3012.45 4,5 mm

11-3012.50 5,0 mm

11-3012.55 5,5 mm

11-3012.60 6,0 mm

18 cm, 7"



DOUGLAS

11-3115.30

Ø 1,75 mm



LICHTWITZ

11-3154.18

Ø 3 mm



COACKLEY

11-2135.30

14 cm, 5 1/2"



Ø 5 mm

FLEURANT

11-3040.00

23 cm, 9"



NELSON

11-3020.25 Charr. 25

11-3020.30 Charr. 30

11-3020.33 Charr. 33

11-3020.35 Charr. 35



Gallenblasentrokare
Gall Bladder Trocars
Trocarts pour vésicule biliaire
Trócar para vesícula biliar

11-3034.10 Charr. 10

11-3034.12 Charr. 12

11-3034.14 Charr. 14

11-3034.16 Charr. 16

11-3034.18 Charr. 18

11-3034.20 Charr. 20

11-3034.22 Charr. 22

11-3034.24 Charr. 24

11-3034.26 Charr. 26

11-3034.28 Charr. 28

OCHSNER

15 cm, 5 3/4"



VERRES

11-3851.00

2,0 x 100 mm

Kanülen für die Leberblindpunktion
Liver Blind Puncture Needles
Aiguilles pour la ponction aveugle du foie
Agujas para la punción ciega del hígado



11-3810.35 1,0 x 35 mm

11-3810.70 1,0 x 70 mm

11-3812.70 1,2 x 70 mm

11-3812.99 1,2 x 100 mm

11-3814.70 1,4 x 70 mm

11-3814.99 1,4 x 100 mm

11-3816.70 1,6 x 70 mm

11-3818.99 1,8 x 100 mm

MENGHINI



11-3830.14 1,4 x 168 mm

11-3830.18 1,8 x 168 mm



11-3830.64 1,4 mm

11-3830.68 1,8 mm

Nadelführung
Trumpet Needle Guide
Aiguille trompette guide
Aguja de guía



IOWA

11-5220.00

Kanülen zur Lumbalpunktion
Lumbar Puncture Needles
Aiguilles pour ponction lombaire
Agujas para punción lumbar

11-5230.12 1,2 x 76 mm

11-5232.12 1,2 x 89 mm

11-5230.10 1,0 x 76 mm

11-5232.10 1,0 x 89 mm

11-5230.07 0,7 x 76 mm

11-5232.07 0,7 x 89 mm



QUINKE

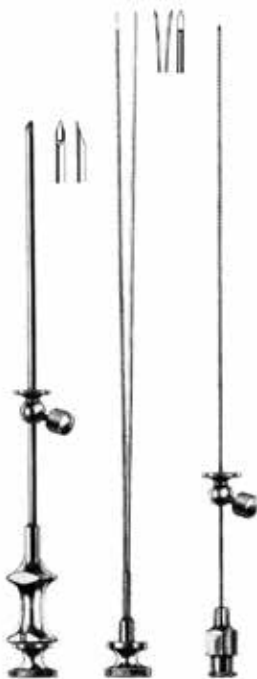

FRANKLIN-SILVERMANN

11-5270.20

2,0 x 105 mm



11-5270.14

2,0 x 130 mm



11-5240.05 5 ml

11-5240.10 10 ml

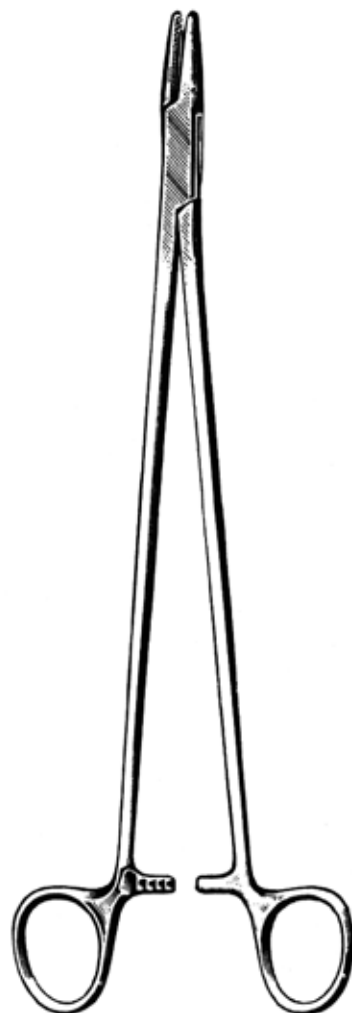



DERF

12-5024.12

12 cm, 4 3/4"



DERF

12-5028.13

12,5 cm, 5"



COLLIER

12-5030.13

12,5 cm, 5"



HALSEY

12-5032.13

13 cm, 5"



HALSEY

12-5034.13

13 cm, 5"

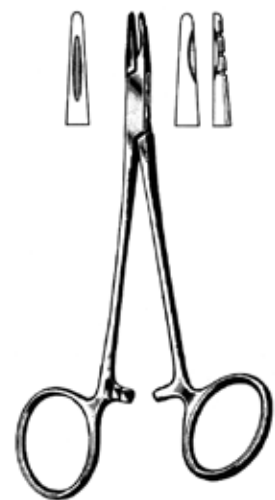

NEIVERT

12-5040.13

13 cm, 5"

Nadelhalter
Needle Holders
Porte-aiguilles
Porta-agujas



BAUMGARTNER

12-5042.13 12,5 cm, 5"

12-5042.14 14 cm, 5 1/2"



CRILE-WOOD

12-5302.15 15 cm, 6"

12-5302.18 18 cm, 7"

12-5302.20 20 cm, 8"



CRILE-MURRAY

12-5320.15

15 cm, 6"



MAYO-HEGAR

12-5220.14 14 cm, 5 1/2"

12-5220.16 16 cm, 6 1/4"

12-5220.18 18 cm, 7"

12-5220.20 20 cm, 8"

12-5220.24 24 cm, 9 1/2"

12-5220.26 26 cm, 10 1/4"

12-5220.30 30 cm, 12"



MAYO-HEGAR

12-5224.16 16 cm, 6 1/4"

12-5224.18 18 cm, 7"

12-5224.20 20 cm, 8"



JAMISON

12-2458.23

23,5 cm, 9 1/4"

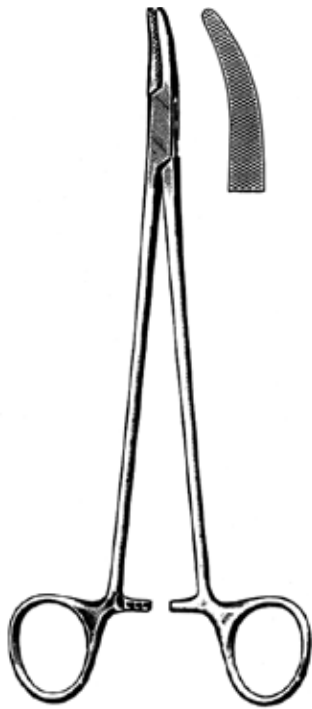

HEANEY

12-2461.21

21 cm, 8 1/2"



METZENBAUM

12-2478.18

18 cm, 7"



ADSON

12-2480.18

18 cm, 7"

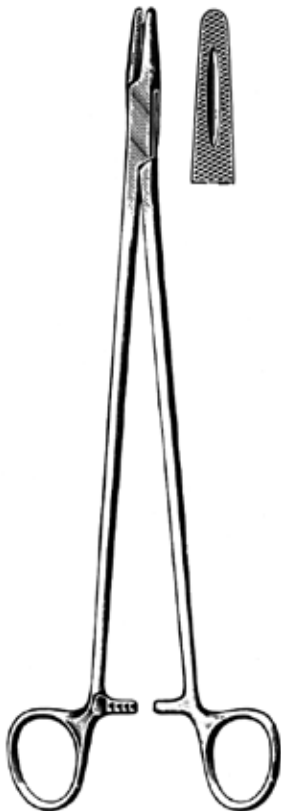

MASSON

12-2466.27

27 cm, 10 3/4"



WANGENSTEEN

12-2470.27

27 cm, 10 3/4"



WANGENSTEEN

12-2474.27

27 cm, 10 3/4"

12

Nadelhalter
Needle Holders
Porte-aiguilles
Porta-agujas



SAROT

12-2488.18 18 cm, 7"

12-2488.26 26 cm, 10 1/4"

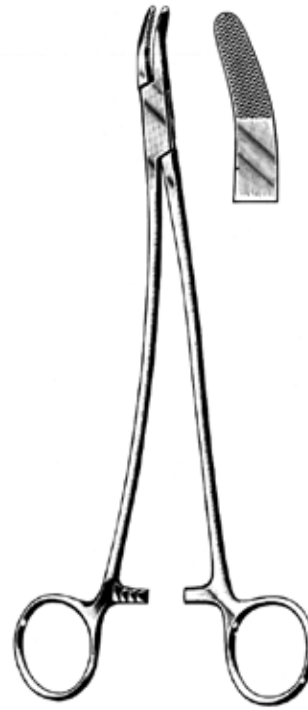

STRATTE

12-2492.23

23 cm, 9"



JOHNSON

12-2481.27

27 cm, 10 3/4"

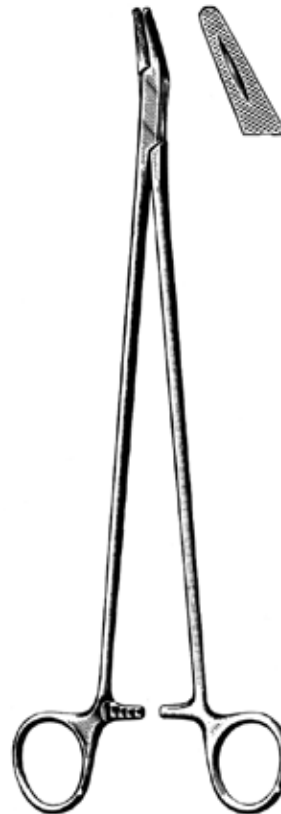

FINOCHIETTO

12-2485.20 20 cm, 8"

12-2485.27 27 cm, 10 3/4"



HOESSEL

12-2503.25

25 cm, 10"



CRILE

12-2496.15

15 cm, 6"



TOENNIS

12-2498.18

18 cm, 7"



MATHIEU

12-2504.14 14 cm, 5 1/2"

12-2504.17 17 cm, 6 3/4"

12-2504.20 20 cm, 8"

12-2504.24 24 cm, 9 1/2"



MATHIEU

12-2508.17 17 cm, 6 3/4"

12-2508.20 20 cm, 8"



MATHIEU

12-2512.14 14 cm, 5 1/2"

12-2512.17 17 cm, 6 3/4"



OLSEN-HEGAR

12-2516.14 14 cm, 5 1/2"

12-2516.18 18 cm, 7"

Nadelhalter
Needle Holders
Porte-aiguilles
Porta-agujas



OLSEN-HEGAR

12-2520.17

17 cm, 6 3/4"

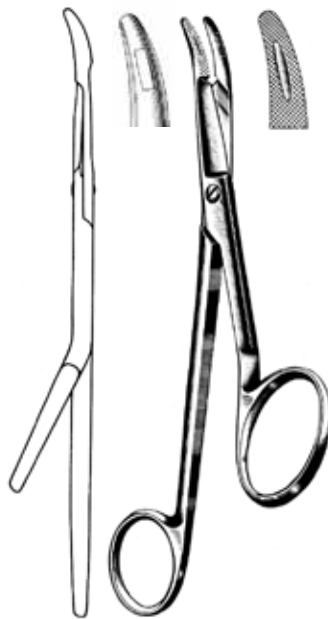

GILLIES

12-2524.16

16 cm, 6 1/4"



STEVENS

12-2532.11

11 cm, 4 1/4"



STEVENS

12-2534.13 13 cm, 5"

12-2534.15 15 cm, 6"



BOYNTON

12-2536.12

12 cm, 4 3/4"



ARRUGA

12-2538.16

16 cm, 6 1/4"



KALT-ARRUGA

12-2541.14

14 cm, 5 1/2"



KALT

12-2544.14

14 cm, 5 1/2"



BARRAQUER

12-2546.10

10 cm, 4"



BARRAQUER

12-2547.10

10 cm, 4"



BARRAQUER

12-2549.13

13 cm, 5"



CASTROVIEJO

12-2552.14

14 cm, 5 1/2"



CASTROVIEJO

12-2553.14

14 cm, 5 1/2"



CASTROVIEJO

12-2556.13

13 cm, 5"

Nadelhalter mit Hartmetalleinlagen
Needle Holders with Tungsten Carbide Inserts
Porte-aiguilles avec mors en tungstène
Porta-agujas con bocas de carburo de tungsteno



DERF
12-5026.12
 12 cm, 4 3/4"



HALSEY
12-5036.13
 13 cm, 5"

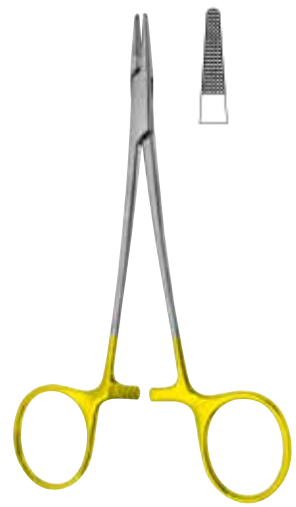

HALSEY
12-5038.13
 13 cm, 5"



BAUMGARTNER
12-5046.13 12,5 cm, 5"
12-5048.14 14 cm, 5 1/2"



CRILE-WOOD
12-5312.15 15 cm, 6"
12-5312.18 18 cm, 7"
12-5312.20 20 cm, 8"

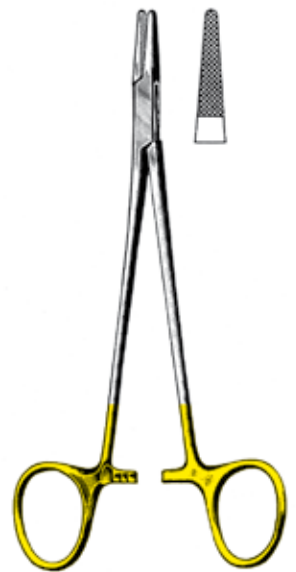

CRILE-MURRAY
12-5322.15
 15 cm, 6"

Nadelhalter mit Hartmetalleinlagen
Needle Holders with Tungsten Carbide Inserts
Porte-aiguilles avec mors en tungstène
Porta-agujas con bocas de carburo de tungsteno

12



MAYO-HEGAR

12-5222.14	14 cm, 5 1/2"
12-5222.16	16 cm, 6 1/4"
12-5222.18	18 cm, 7"
12-5222.20	20 cm, 8"
12-5222.24	24 cm, 9 1/2"
12-5222.26	26 cm, 10 1/4"
12-5222.30	30 cm, 12"



MAYO-HEGAR

12-5228.16	16 cm, 6 1/4"
12-5228.18	18 cm, 7"
12-5228.20	20 cm, 8"

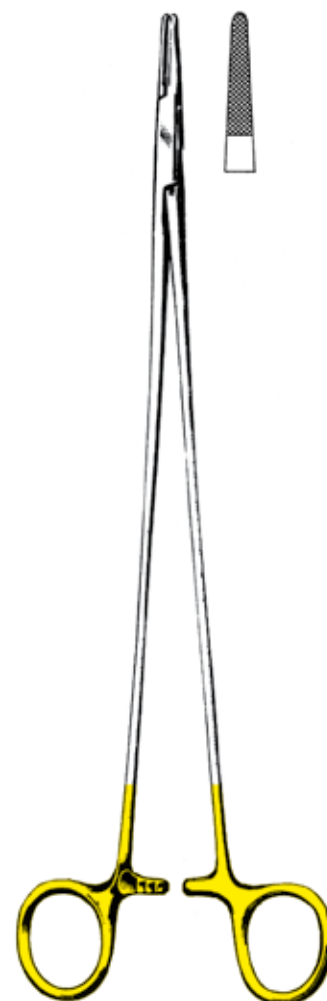

DE BAKEY

12-5450.15	15 cm, 6"
12-5450.18	18 cm, 7"
12-5450.20	20 cm, 8"
12-5450.23	23 cm, 9"
12-5450.26	26 cm, 10 1/4"
12-5450.28	28 cm, 11"
12-5450.30	30 cm, 12"

Nadelhalter mit Hartmetalleinlagen
Needle Holders with Tungsten Carbide Inserts
Porte-aiguilles avec mors en tungstène
Porta-agujas con bocas de carburo de tungsteno



RYDER

12-5456.13	13 cm, 5"
12-5456.15	15 cm, 6"
12-5456.18	18 cm, 7"
12-5456.20	20 cm, 8"
12-5456.23	23 cm, 9"



HEANEY

12-2463.21	21 cm, 8 1/2"
-------------------	---------------



SAROT

12-2490.18	18 cm, 7"
12-2490.26	26 cm, 10 1/4"



JAMISON

12-2460.23	23,5 cm, 9 1/4"
-------------------	-----------------

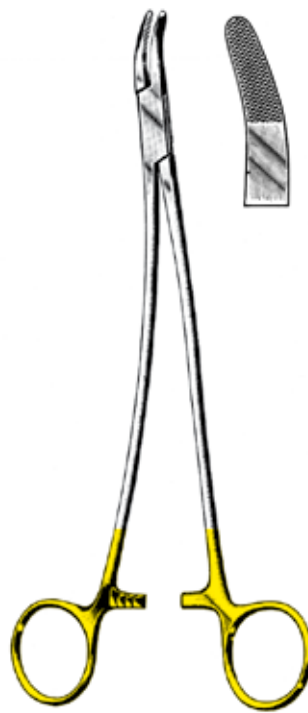

STRATTE

12-2494.23	23 cm, 9"
-------------------	-----------



BOZEMANN

12-2477.20	20 cm, 8"
12-2477.24	24 cm, 9 1/2"
12-2477.26	26 cm, 10 1/4"

Nadelhalter mit Hartmetalleinlagen
Needle Holders with Tungsten Carbide Inserts
Porte-aiguilles avec mors en tungstène
Porta-agujas con bocas de carburo de tungsteno

12

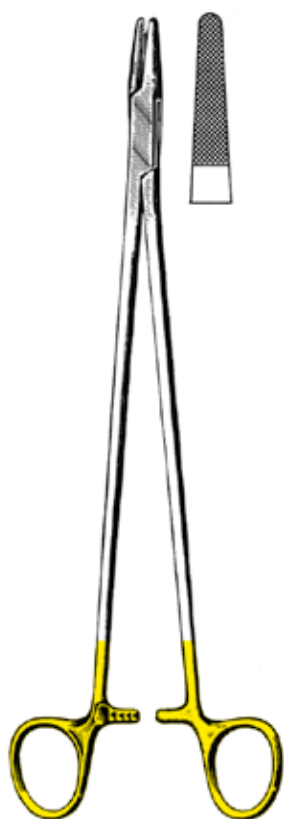

MASSON

12-2468.27

27 cm, 10 3/4"



WANGENSTEEN

12-2472.27

27 cm, 10 3/4"

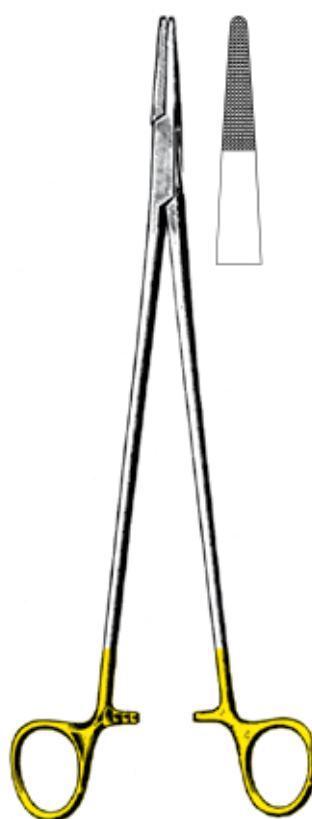

WANGENSTEEN

12-2476.27

27 cm, 10 3/4"

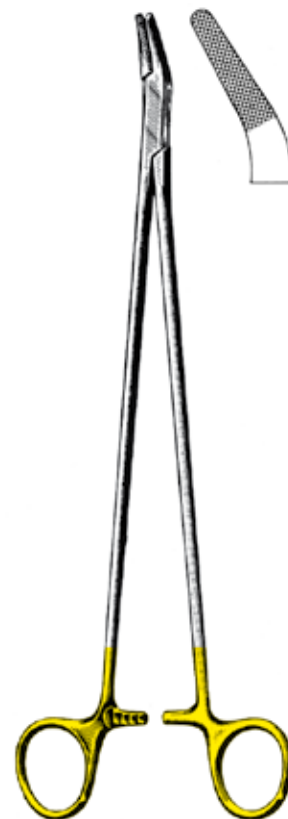

FINOCHIETTO

12-2487.20 20 cm, 8"

12-2487.27 27 cm, 10 3/4"

Nadelhalter mit Hartmetalleinlagen
Needle Holders with Tungsten Carbide Inserts
Porte-aiguilles avec mors en tungstène
Porta-agujas con bocas de carburo de tungsteno



MATHIEU

12-2506.14 14 cm, 5 1/2"

12-2506.17 17 cm, 6 3/4"

12-2506.20 20 cm, 8"

12-2506.24 24 cm, 9 1/2"



MATHIEU

12-2510.17 17 cm, 6 3/4"

12-2510.20 20 cm, 8"



MATHIEU

12-2514.14 14 cm, 5 1/2"

12-2514.17 17 cm, 6 3/4"



OLSEN-HEGAR

12-2518.14 14 cm, 5 1/2"

12-2518.18 18 cm, 7"



OLSEN-HEGAR

12-2522.17

17 cm, 6 3/4"

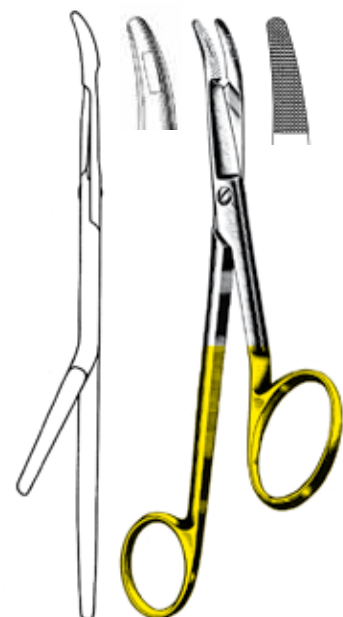

GILLIES

12-2528.16

16 cm, 6 1/4"

Nadelhalter mit Hartmetalleinlagen
Needle Holders with Tungsten Carbide Inserts
Porte-aiguilles avec mors en tungstène
Porta-agujas con bocas de carburo de tungsteno



DIETRICH

12-2530.16	16 cm, 6 1/4"
12-2530.18	18 cm, 7"
12-2530.20	20 cm, 8"
12-2530.23	23 cm, 9"
12-2530.26	26 cm, 10 1/4"



ARRUGA

12-2540.16	16 cm, 6 1/4"
-------------------	---------------



TOENNIS

12-2500.18	18 cm, 7"
-------------------	-----------



BARRAQUER

12-2549.13	13 cm, 5"
-------------------	-----------



CASTROVIEJO

12-2555.14	14 cm, 5 1/2"
-------------------	---------------



CASTROVIEJO

12-2557.14	14 cm, 5 1/2"
-------------------	---------------



CASTROVIEJO

12-2558.13	13 cm, 5"
-------------------	-----------



Unterbindungsnadeln
Ligature Needles
Aiguilles à ligatures
Agujas para ligaduras



für die rechte Hand, scharf
 for the right hand, sharp
 pour la main droite, pointue
 para la mano derecha, aguda

13-0721.21 21 cm, 8 1/4"

13-0721.24 24 cm, 9 1/2"

13-0721.27 27 cm, 10 1/2"

DESCHAMPS



für die linke Hand, scharf
 for the left hand, sharp
 pour la main gauche, pointue
 para la mano izquierda, aguda

13-0723.21 21 cm, 8 1/4"

13-0723.24 24 cm, 9 1/2"

13-0723.27 27 cm, 10 1/2"

DESCHAMPS



für die rechte Hand, stumpf
 for the right hand, blunt
 pour la main droite, mousse
 para la mano derecha, roma

13-0725.21 21 cm, 8 1/4"

13-0725.24 24 cm, 9 1/2"

13-0725.27 27 cm, 10 1/2"

DESCHAMPS



für die linke Hand, stumpf
 for the left hand, blunt
 pour la main gauche, mousse
 para la mano izquierda, roma

13-0727.21 21 cm, 8 1/4"

13-0727.24 24 cm, 9 1/2"

13-0727.27 27 cm, 10 1/2"

DESCHAMPS

Unterbindungsnadeln
Ligature Needles
Aiguilles à ligatures
Agujas para ligaduras



KRONECKER

13-0714.13

13 cm, 5"



KRONECKER

13-0715.13

13 cm, 5"



COOPER

13-0765.19

19 cm, 7 1/2"



NELSON

13-0717.24

24,5 cm, 9 3/4"



NELSON

13-0718.24

24,5 cm, 9 3/4"



YOUNG

13-1027.00

25 cm, 10"



13-1027.01

Fig. 1



13-1027.02

Fig. 2



13-1027.03

Fig. 3

**Unterbindungsnadeln
Ligature Needles
Aiguilles à ligatures
Agujas para ligaduras**



REVERDIN

Fig. 1



13-1015.01

15 cm, 6"

Fig. 2



13-1015.02

15 cm, 6"

Fig. 3



13-1015.03

15 cm, 6"

Fig. 4



13-1015.04

15 cm, 6"



REVERDIN

Fig. 1



13-1019.01

13-1021.01

13-1023.01

Fig. 2



13-1019.02

13-1021.02

13-1023.02

Fig. 3



13-1019.03

13-1021.03

13-1023.03

Fig. 4



13-1019.04

13-1021.04

13-1023.04

19,5 cm, 7 3/4"

21 cm, 8 1/4"

22,5 cm, 8 3/4"

Führungshohlsonden
Ligature Conductors
Sondes conductrices
Sondas conductoras



SCHMIEDEN

13-2068.19

19 cm, 7 1/2"

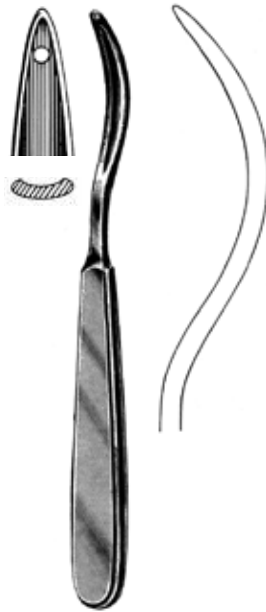

SCHMIEDEN-PAYR

13-2069.19

19 cm, 7 1/2"



PAYR

13-2110.22

22 cm, 8 3/4"



PAYR

13-2111.22

22 cm, 8 3/4"

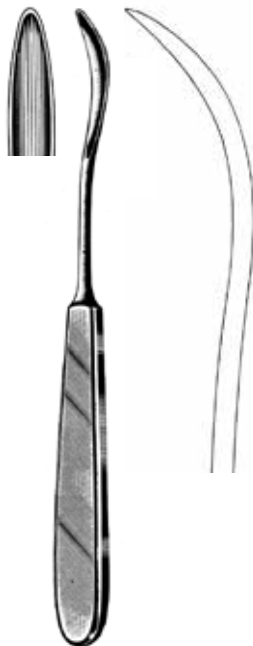

KOENIG

13-2089.20

20 cm, 8"



KIRSCHNER

13-2035.25

25,5 cm, 10"



BRUNNER

13-2030.01

30 cm, 12"

Kunststoff
 Plastic Material
 Matière plastique
 Materia plástica



BRUNNER

13-2125.18 18 cm, 7"

13-2125.27 27 cm, 10 1/2"

Nähnadeln Suturing Needles Aiguilles à sutures Agujas para suturas

alle Nadeln mit Federöhr
all the needles with spring eye
toutes les aiguilles à chas à ressort
todas la agujas con ojo de resorte

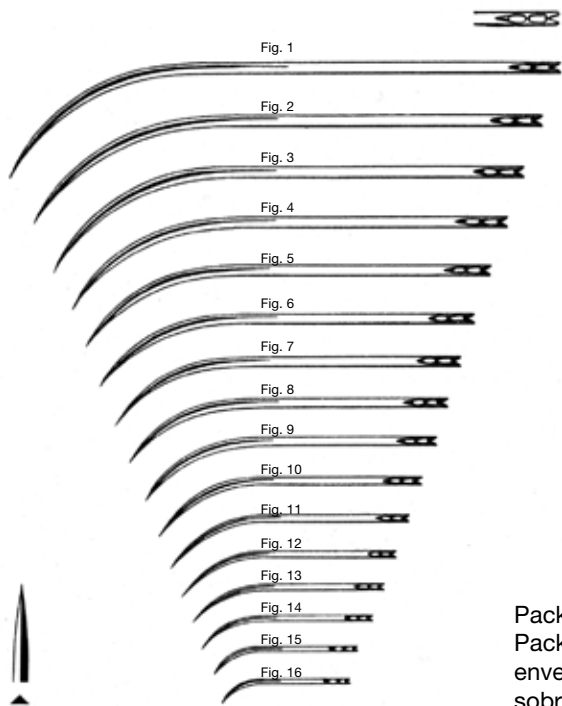

Packung 1 Dutzend
Package 1 dozen
enveloppe 1 douzaine
sobre 1 dozana

13-8010.01	Fig. 1
13-8010.02	Fig. 2
13-8010.03	Fig. 3
13-8010.04	Fig. 4
13-8010.05	Fig. 5
13-8010.06	Fig. 6
13-8010.07	Fig. 7
13-8010.08	Fig. 8
13-8010.09	Fig. 9
13-8010.10	Fig. 10
13-8010.11	Fig. 11
13-8010.12	Fig. 12
13-8010.13	Fig. 13
13-8010.14	Fig. 14
13-8010.15	Fig. 15
13-8010.16	Fig. 16

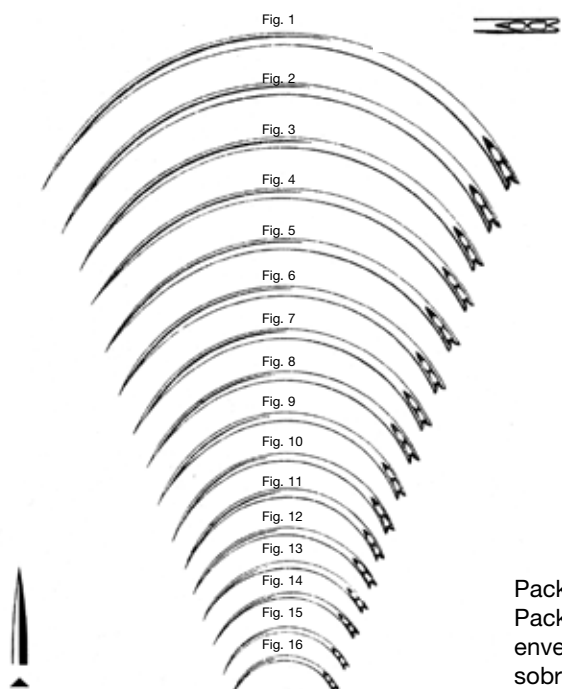

Packung 1 Dutzend
Package 1 dozen
enveloppe 1 douzaine
sobre 1 dozana

13-8011.01	Fig. 1
13-8011.02	Fig. 2
13-8011.03	Fig. 3
13-8011.04	Fig. 4
13-8011.05	Fig. 5
13-8011.06	Fig. 6
13-8011.07	Fig. 7
13-8011.08	Fig. 8
13-8011.09	Fig. 9
13-8011.10	Fig. 10
13-8011.11	Fig. 11
13-8011.12	Fig. 12
13-8011.13	Fig. 13
13-8011.14	Fig. 14
13-8011.15	Fig. 15
13-8011.16	Fig. 16

Nähnadeln

Suturing Needles

Aiguilles à sutures

Agujas para suturas

alle Nadeln mit Federöhr
 all the needles with spring eye
 toutes les aiguilles à chas à ressort
 todas la agujas con ojo de resorte

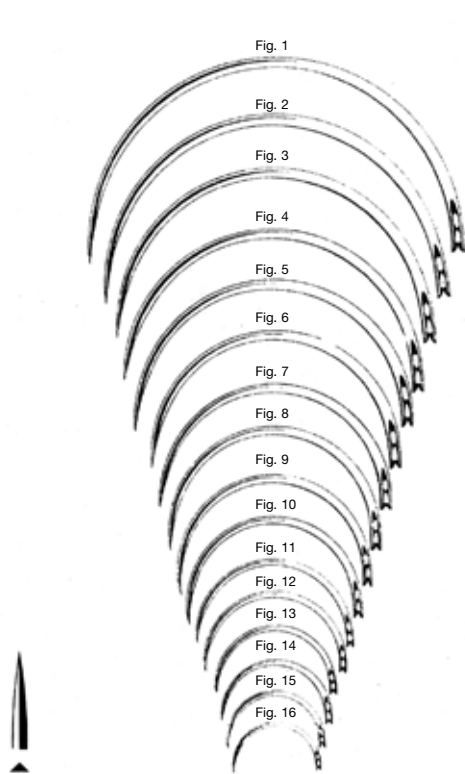

Packung 1 Dutzend
 Package 1 dozen
 enveloppe 1 douzaine
 sobre 1 dozana

13-8012.01	Fig. 1
13-8012.02	Fig. 2
13-8012.03	Fig. 3
13-8012.04	Fig. 4
13-8012.05	Fig. 5
13-8012.06	Fig. 6
13-8012.07	Fig. 7
13-8012.08	Fig. 8
13-8012.09	Fig. 9
13-8012.10	Fig. 10
13-8012.11	Fig. 11
13-8012.12	Fig. 12
13-8012.13	Fig. 13
13-8012.14	Fig. 14
13-8012.15	Fig. 15
13-8012.16	Fig. 16

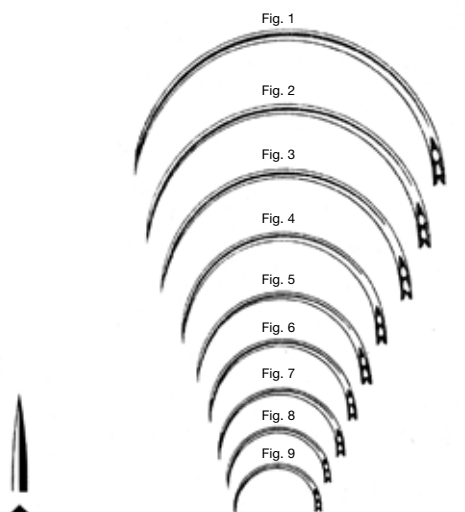

Packung 1 Dutzend
 Package 1 dozen
 enveloppe 1 douzaine
 sobre 1 dozana

13-8013.01	Fig. 1
13-8013.02	Fig. 2
13-8013.03	Fig. 3
13-8013.04	Fig. 4
13-8013.05	Fig. 5
13-8013.06	Fig. 6
13-8013.07	Fig. 7
13-8013.08	Fig. 8
13-8013.09	Fig. 9

Nähnadeln
Suturing Needles
Aiguilles à sutures
Agujas para suturas

alle Nadeln mit Federöhr
 all the needles with spring eye
 toutes les aiguilles à chas à ressort
 todas la agujas con ojo de resorte

13

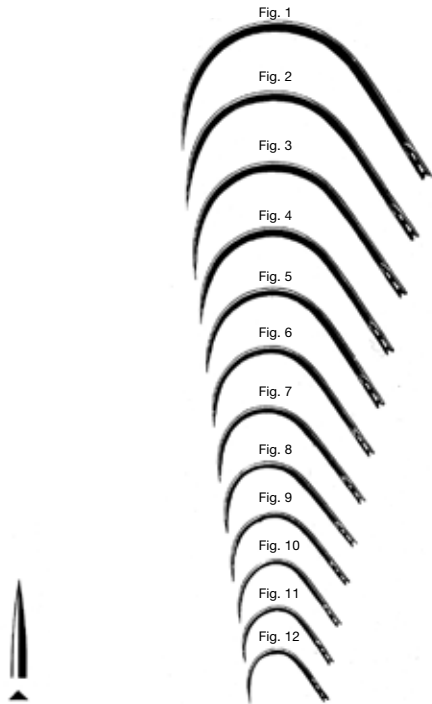

Packung 1 Dutzend
 Package 1 dozen
 enveloppe 1 douzaine
 sobre 1 dozana

KOENIG

13-8015.01	Fig. 1
13-8015.02	Fig. 2
13-8015.03	Fig. 3
13-8015.04	Fig. 4
13-8015.05	Fig. 5
13-8015.06	Fig. 6
13-8015.07	Fig. 7
13-8015.08	Fig. 8
13-8015.09	Fig. 9
13-8015.10	Fig. 10
13-8015.11	Fig. 11
13-8015.12	Fig. 12

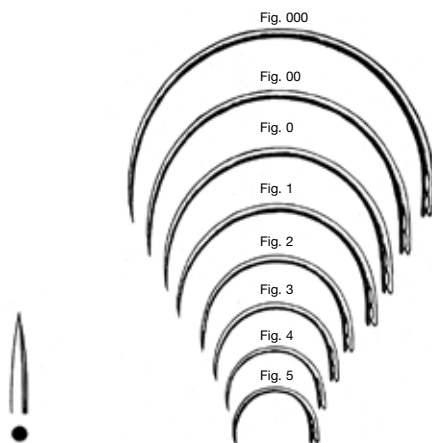

Packung 1 Dutzend
 Package 1 dozen
 enveloppe 1 douzaine
 sobre 1 dozana

13-8016.30	Fig.000
13-8016.20	Fig. 00
13-8016.10	Fig. 0
13-8016.01	Fig. 1
13-8016.02	Fig. 2
13-8016.03	Fig. 3
13-8016.04	Fig. 4
13-8016.05	Fig. 5

Nähnadeln
Suturing Needles
Aiguilles à sutures
Agujas para suturas

alle Nadeln mit Federöhr
 all the needles with spring eye
 toutes les aiguilles à chas à ressort
 todas la agujas con ojo de resorte

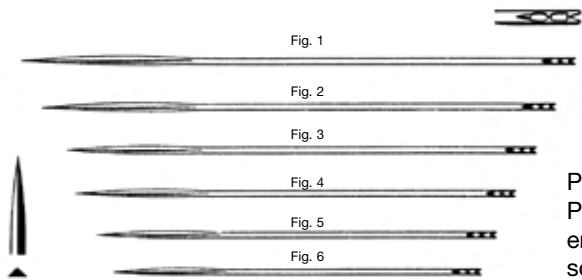

Packung 1 Dutzend
 Package 1 dozen
 enveloppe 1 douzaine
 sobre 1 dozena

KEITH

13-8018.01	Fig. 1
13-8018.02	Fig. 2
13-8018.03	Fig. 3
13-8018.04	Fig. 4
13-8018.05	Fig. 5
13-8018.06	Fig. 6

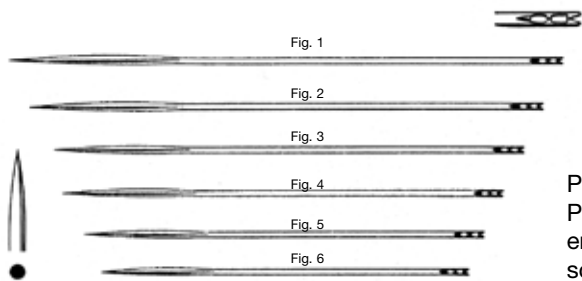

Packung 1 Dutzend
 Package 1 dozen
 enveloppe 1 douzaine
 sobre 1 dozena

KEITH

13-8020.01	Fig. 1
13-8020.02	Fig. 2
13-8020.03	Fig. 3
13-8020.04	Fig. 4
13-8020.05	Fig. 5
13-8020.06	Fig. 6

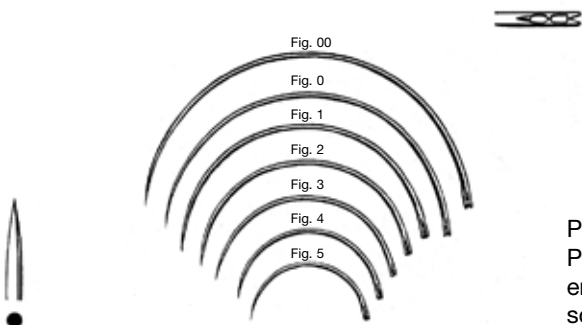

Packung 1 Dutzend
 Package 1 dozen
 enveloppe 1 douzaine
 sobre 1 dozena

13-8021.20	Fig. 00
13-8021.10	Fig. 0
13-8021.01	Fig. 1
13-8021.02	Fig. 2
13-8021.03	Fig. 3
13-8021.04	Fig. 4
13-8021.05	Fig. 5

Nähnadeln

Suturing Needles

Aiguilles à suture

Agujas para suturas

alle Nadeln mit Federöhr
 all the needles with spring eye
 toutes les aiguilles à chas à ressort
 todas la agujas con ojo de resorte

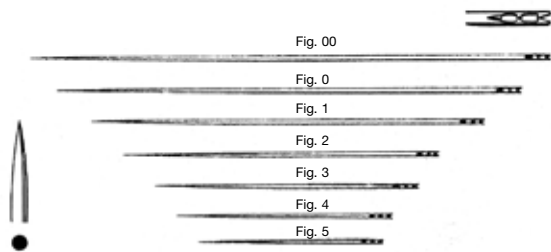

Packung 1 Dutzend
 Package 1 dozen
 enveloppe 1 douzaine
 sobre 1 dozena

13-8022.20	Fig. 00
13-8022.10	Fig. 0
13-8022.01	Fig. 1
13-8022.02	Fig. 2
13-8022.03	Fig. 3
13-8022.04	Fig. 4
13-8022.05	Fig. 5

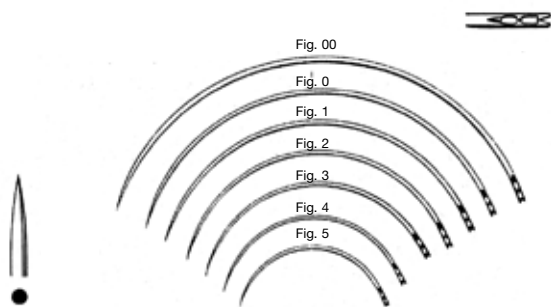

Packung 1 Dutzend
 Package 1 dozen
 enveloppe 1 douzaine
 sobre 1 dozena

13-8023.20	Fig. 00
13-8023.10	Fig. 0
13-8023.01	Fig. 1
13-8023.02	Fig. 2
13-8023.03	Fig. 3
13-8023.04	Fig. 4
13-8023.05	Fig. 5

Wundklammern, Wundinstrumente
Clips and Instruments
Agrafes et instruments
Agrafes e instrumentos



MICHEL

13-5720.12

12 cm, 4 3/4"



WACHENFELDT

13-5730.12

12 cm, 4 3/4"



WACHENFELDT

13-5732.12

12 cm, 4 3/4"



HEGENBARTH

13-5734.12

12,5 cm, 5"



CHILDE

13-5711.18

18 cm, 7"



MICHEL

13-9060.12

12 cm, 4 3/4"



MICHEL

13-9061.13

13 cm, 5"



COLLIN

13-9067.13

13 cm, 5"



RICHTER-HEATH

13-9069.14

14 cm, 5 1/2"

Wundklammern, Taschen und Nahtbestecke
Clips and Instruments, Pocket and suturing Kits
Agrafes et instruments, Trousses à poche et à suture
Agrafes e instrumentos, Estuches de bolsillo y de sutura



MICHEL

13-9510.07	7,5 x 1,75 mm
13-9510.11	11 x 2 mm
13-9510.12	12 x 3 mm
13-9510.14	14 x 3 mm
13-9510.16	16 x 3 mm
13-9510.18	18 x 3 mm
13-9510.20	20 x 3 mm
13-9510.22	22 x 3 mm



WACHENFELDT

13-9010.12	12 x 3 mm
13-9010.14	14 x 3 mm
13-9010.16	16 x 3 mm
13-9010.18	18 x 3 mm
13-9010.20	20 x 3 mm



13-9500.00

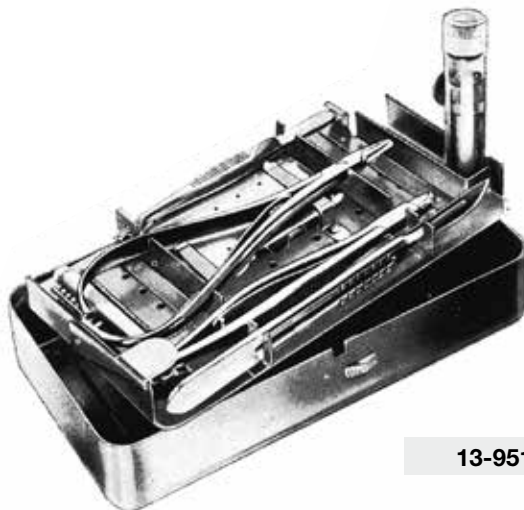

13-9514.60

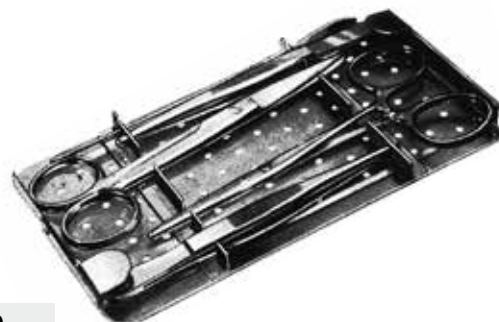

Sterilisationsinstrumente
Sterilization Instruments
Instrumentos à stérilisation
Instrumentos para la esterilización



DAVIS

13-5821.16 16 cm, 6 3/4"

13-5821.20 20 cm, 8"

13-5821.24 24 cm, 9 1/2"



UNIVERSAL

13-9956.20 20 cm, 8"

13-9956.28 28 cm, 11"



UNIVERSAL

13-9957.20 20 cm, 8"

13-9957.28 28 cm, 11"



CHEATLE

13-9955.27

27 cm, 10 1/2"



ROGGE

13-9954.23

23 cm, 9"



13-9952.20 20 cm, 8"

13-9952.30 30 cm, 12"



BUNT

13-9960.12

12 cm, 4 1/4"

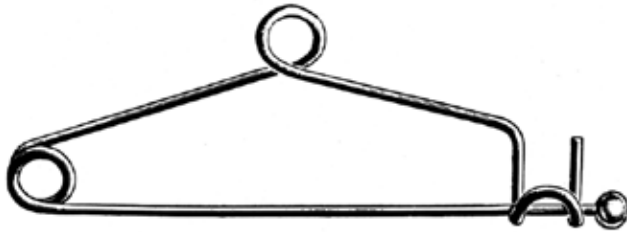

MAYO

13-9962.14

14 cm, 5 1/2"

13

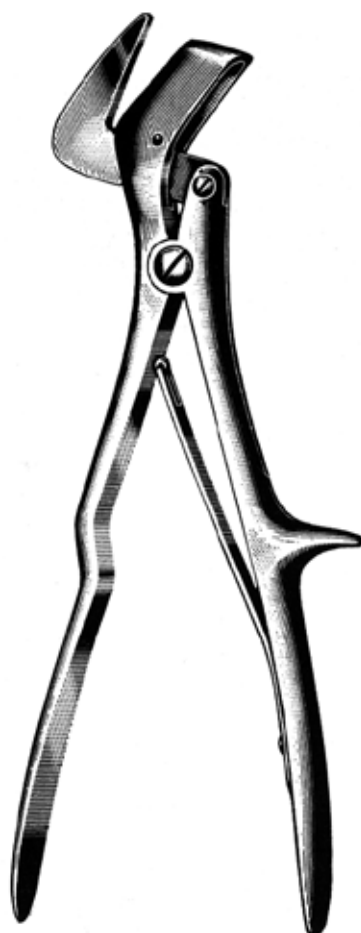



STILLE

14-0620.24

24 cm, 9 1/2"



STILLE

14-0600.23 23 cm, 9"

14-0600.26 26 cm, 10 1/4"

14-0600.37 37 cm, 14 1/2"



WIGMORE

14-0622.19

19 cm, 7 1/2"



ENGEL

14-0710.14

14 cm, 5 1/2"

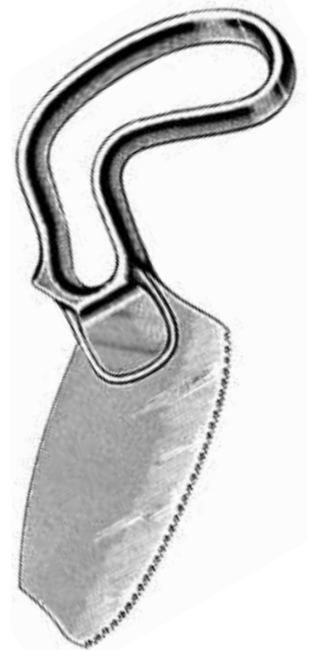

BERGMANN

14-0712.18

18 cm, 7"

Gipsverband
 Plaster of Paris
 Appareils platres
 Vendajes enyesados



HAGLUND-STILLE

14-0920.28

28 cm, 11"

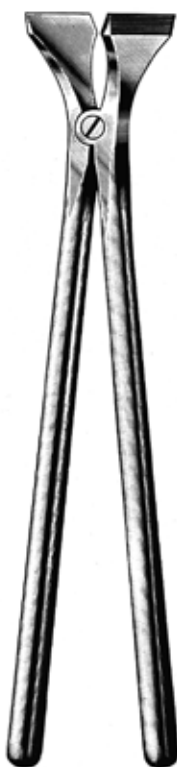

BEESON

14-0922.30

30 cm, 11 3/4"



HENNIG

14-0924.28

28 cm, 11"



MOD. USA

14-0930.23

23 cm, 9"



HOPKINS

14-0932.20

20 cm, 8"



ESMARCH

14-0934.18

18 cm, 7"



REINER

14-0936.18

18 cm, 7"



WOLFF

14-0953.18

18 cm, 7"



WOLFF

14-0953.24

24 cm, 9 1/2"

Elektrische Gipssäge
Electric Plaster Cast Cutter
Scie électrique à plâtre
Sierra electrica para yesos



14-0810.11	110 V
14-0810.22	220 V

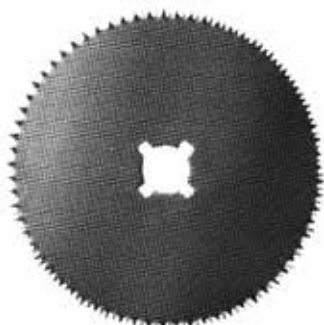

14-0810.50	Ø 50 mm
14-0810.65	Ø 65 mm

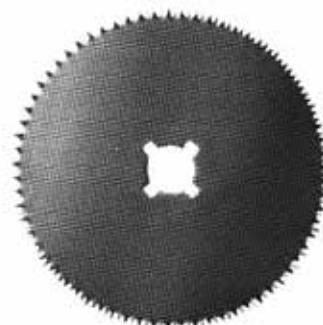

14-0811.50	Ø 50 mm
14-0811.65	Ø 65 mm

spezialgehärtet
 special hardness
 acier trempé
 templada especial



14-0812.13

14





MINI-FRIEDMANN

15-0531.12

12 cm, 4 3/4"



MINI-FRIEDMANN

15-0533.14

14 cm, 5 1/2"



90°

FRIEDMANN

15-0535.90

14 cm, 5 1/2"



FRIEDMANN

15-0540.15

15 cm, 5 3/4"



CLEVELAND

15-0544.14

14 cm, 5 1/2"



CLEVELAND

15-0544.17

17 cm, 6 3/4"



MEAD

15-0561.17

16,5 cm, 6 1/2"



MEAD

15-0563.16

16,5 cm, 6 1/2"

Hohlmeißelzangen
 Bone Rongeurs
 Pincés-gouges
 Pinzas-gubias



BLUMENTHAL

15-0576.30

15,5 cm, 6"



BLUMENTHAL

15-0576.45

15,5 cm, 6"



BLUMENTHAL

15-0576.90

15,5 cm, 6"



LUER

15-0655.01

15 cm, 5 3/4"



LUER

15-0655.02

15 cm, 5 3/4"



LUER



15-0650.17

17 cm, 6 3/4"



15-0651.17

17 cm, 6 3/4"



OLIVECRONA

15-0677.20

20 cm, 8"

Hohlmeißelzangen
 Bone Rongeurs
 Pincés-gouges
 Pinzas-gubias



ADSON



15-0670.20
 20 cm, 8"



15-0671.20
 20 cm, 8"



LEMPERT



15-0636.16
 16 cm, 6 1/4"



15-0637.16
 16 cm, 6 1/4"



15-0638.18
 18,5 cm, 7 1/4"



15-0639.18
 18,5 cm, 7 1/4"



BEYER

15-1011.18
 18 cm, 7"



ZAUFAL-JANSEN

15-1013.18
 18 cm, 7"



RUSKIN

15-1055.23
 23 cm, 9"

Hohlmeißelzangen
 Bone Rongeurs
 Pincés-gouges
 Pinzas-gubias



15-1000.15
 15 cm, 5 3/4"



15-1001.15
 15 cm, 5 3/4"



15-1050.18
 18 cm, 7"



15-1051.18
 18 cm, 7"

BÖHLER

RUSKIN

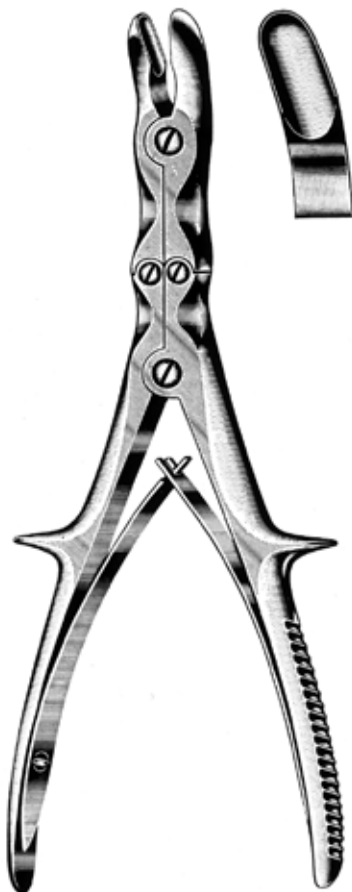

STILLE-RUSKIN
15-1061.23
 23 cm, 9"



STILLE-LUER
15-1065.23
 23 cm, 9"



ECHLIN
15-1133.31
 23 cm, 9"



15-1090.26

26 cm, 10 1/4"



15-1091.22

22 cm, 8 3/4"

15-1091.26

26 cm, 10 1/4"

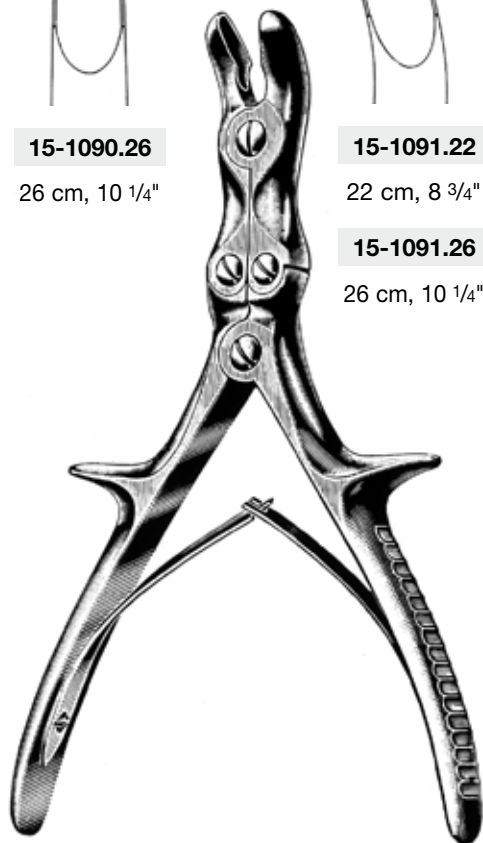

STILLE-LUER



SEMB

15-1095.23

23 cm, 9"



FRYKHOLM

15-1135.24

24 cm, 9 1/2"

Hohlmeißelzangen
 Bone Rongeurs
 Pincés-gouges
 Pinzas-gubias



LEKSELL

Fig.1



15-1128.05

23 cm, 9"

Fig.2



15-1128.08

23 cm, 9"



SAUERBRUCH

Fig.1



15-1162.21

30 cm, 12"

Fig.2



15-1163.21

30 cm, 12"

Knochensplitterzangen
Bone Cutting Forceps
Pincès coupantes à os
Pinzas cortantes para huesos



LISTON



15-0150.14	14 cm, 5 1/2"	15-0151.14
15-0150.17	17 cm, 6 3/4"	15-0151.17
15-0150.19	19 cm, 7 1/2"	15-0151.19
15-0150.22	22 cm, 8 3/4"	15-0151.22



BÖHLER



15-0200.15	15 cm, 6"	15-0201.15	15 cm, 6"
------------	-----------	------------	-----------



COTTLE-KAZANJIAN

15-0110.19

19 cm, 7 1/2"

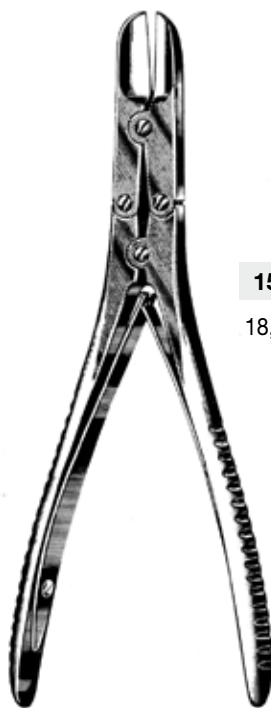

RUSKIN-LISTON

15-0210.19
18,5 cm, 7 1/4"



15-0211.19
18,5 cm, 7 1/4"

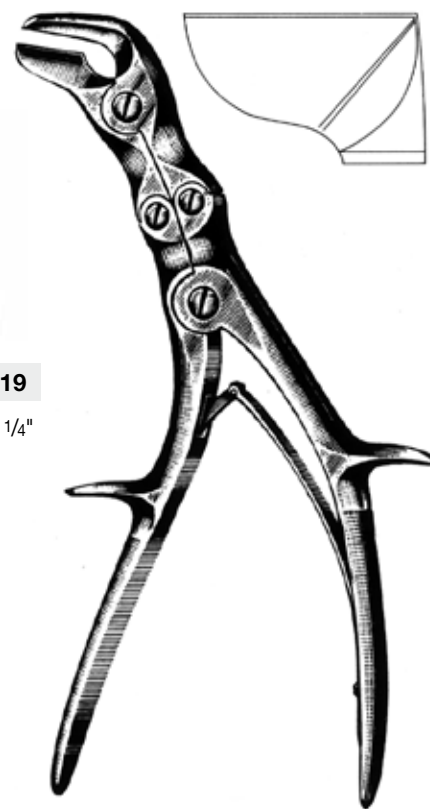

SEMB

15-0307.23

24 cm, 9 1/2"



Knochensplitterzangen
Bone Cutting Forceps
Pinces coupantes à os
Pinzas cortantes para huesos

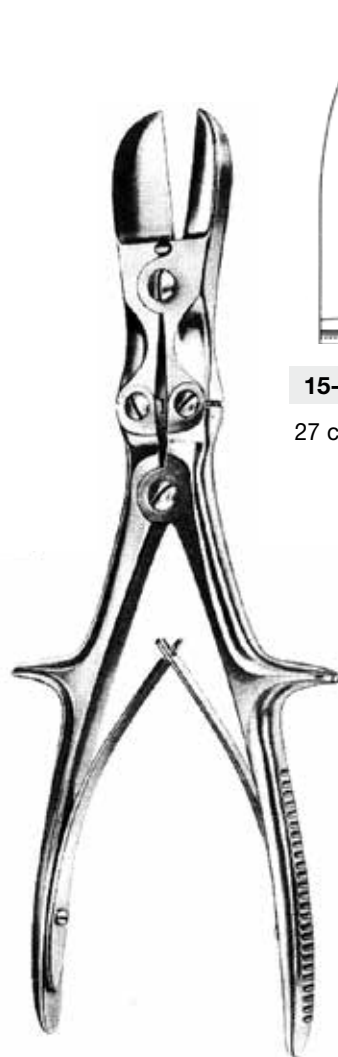

STILLE-LISTON

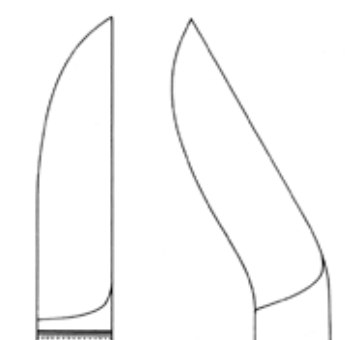

15-0300.27

27 cm, 10 1/4"

15-0301.27

27 cm, 10 1/4"

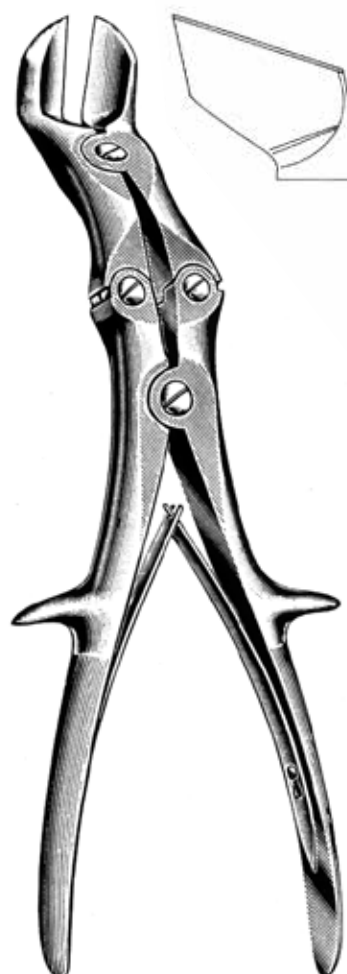

LISTON-KEY-HORSLEY

15-0305.27

27 cm, 10 3/4"

Knochenhalte­zangen
Bone Holding Forceps
Daviers porte-os
Pinzas para agarrar huesos



FERGUSSON

15-2150.21

21 cm, 8 1/4"



LANGENBECK

15-2152.21

21 cm, 8 1/4"



SEMB

15-2131.19

19 cm, 7 1/2"



FARABEU

15-2313.23 23 cm, 9"

15-2313.26 26 cm, 10 1/4"



FARABEU-F-LAMBOTTE

15-2315.26

26 cm, 10 1/4"



LAMBOTTE

15-2320.22 22 cm, 8 3/4"

15-2320.27 27 cm, 10 1/2"

15-2320.30 30 cm, 12"

15

Knochenhaltezangen
Bone Holding Forceps
Daviers porte-os
Pinzas para agarrar huesos



LAMBOTTE

15-2330.22	22 cm, 8 3/4"
15-2330.26	26 cm, 10 1/4"
15-2330.33	33 cm, 13"



LAMBOTTE

15-2331.19	19 cm, 7 1/2"
15-2331.23	23 cm, 9"
15-2331.26	26 cm, 10 1/4"

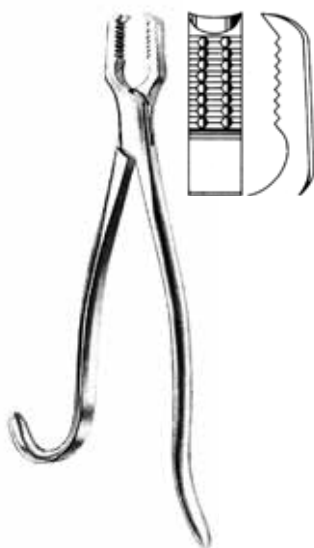

KERN

15-2340.15	15 cm, 5 3/4"
15-2340.17	17 cm, 6 3/4"
15-2340.21	21 cm, 8 1/4"

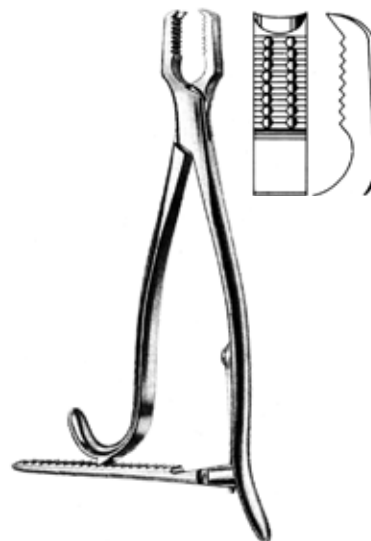

KERN

15-2342.15	15 cm, 5 3/4"
15-2342.17	17 cm, 6 3/4"
15-2342.21	21 cm, 8 1/4"

Knochenhalte­zangen
Bone Holding Forceps
Daviers porte-os
Pinzas para agarrar huesos

15

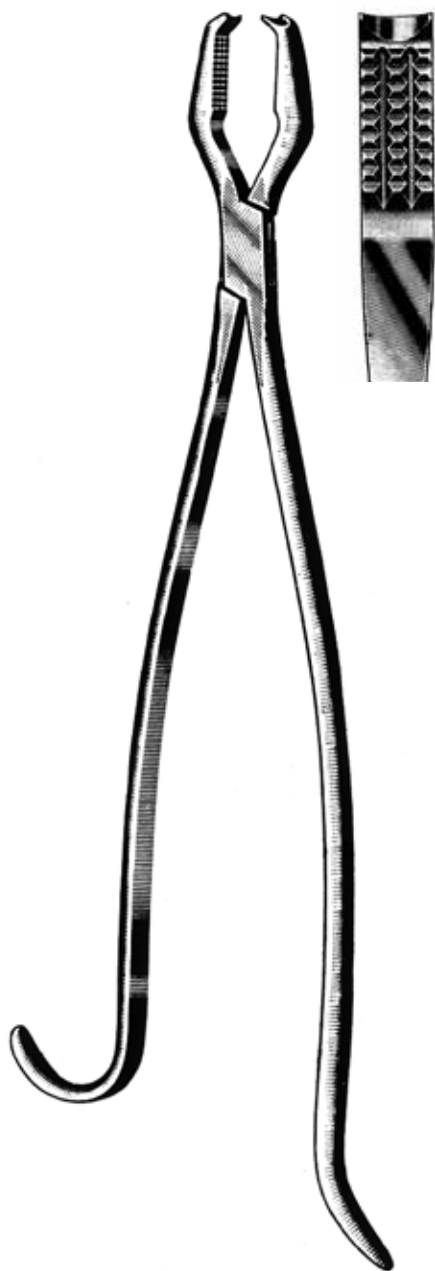

LANE

15-2360.33 33 cm, 13"

15-2360.45 45 cm, 17"



LANE

15-2362.33 33 cm, 13"

15-2362.45 45 cm, 17"

Knochenhalte­zangen
Bone Holding Forceps
Daviers porte-os
Pinzas para agarrar huesos



15-2205.15

15 cm, 6"

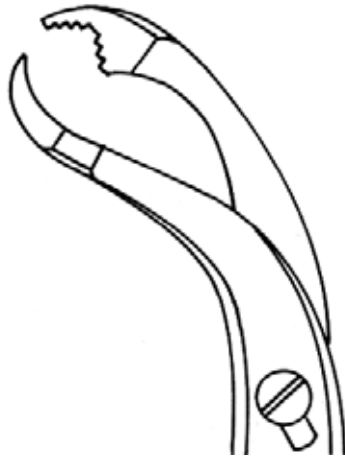

15-2205.19

19 cm, 7 1/2"

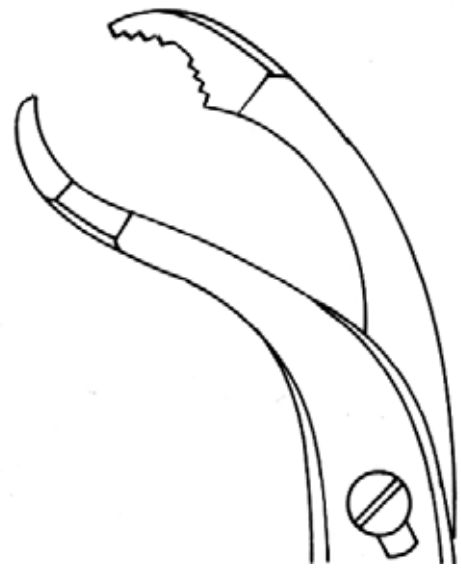

15-2205.24

24 cm, 9 1/2"



15-2205.26

26 cm, 10 1/4"

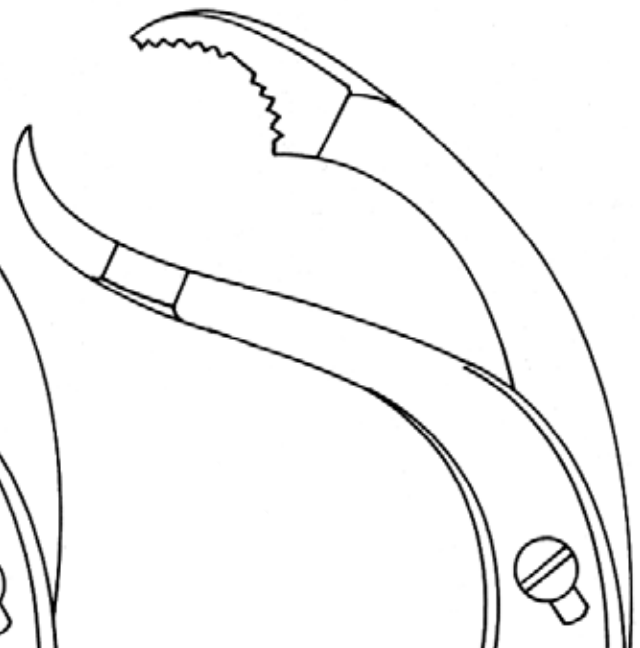

15-2205.28

28 cm, 11"



Knochenhalte-, Sequesterzangen
Bone Holding Forceps, Sequester Forceps
Daviers porte-os, à séquestres
Pinzas para huesos y secuestros

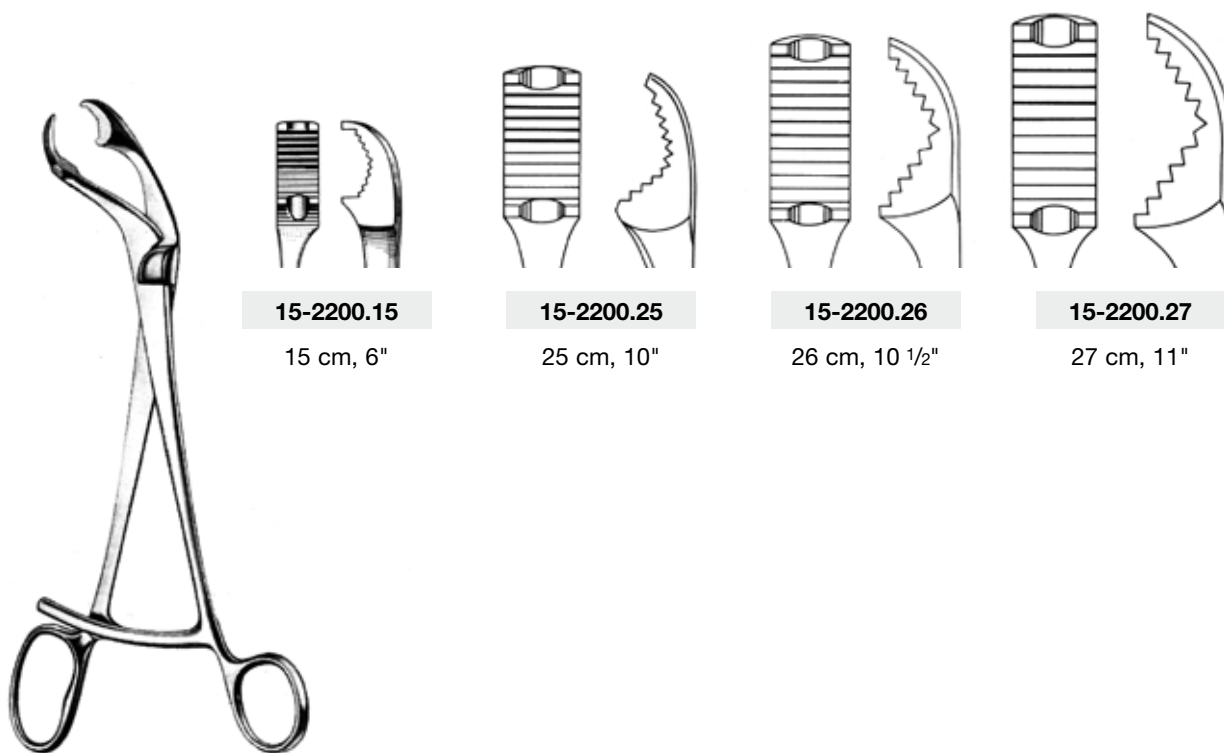

15-2200.15

15 cm, 6"

15-2200.25

25 cm, 10"

15-2200.26

26 cm, 10 1/2"

15-2200.27

27 cm, 11"

VERBRUGGE

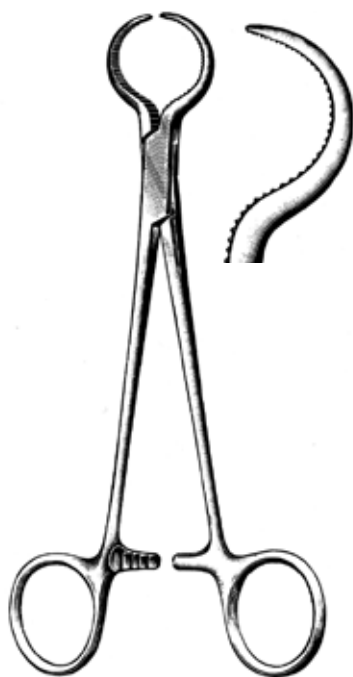

LEWIN

15-2039.17

17,5 cm, 7"



BIRCHER-GANSKE

15-2002.20

20 cm, 8"



BIRCHER-GANSKE

15-2003.20

20 cm, 8"

15

Knochenhalte-, Sequesterzangen
Bone Holding Forceps, Sequester Forceps
Daviers porte-os, à séquestres
Pinzas para huesos y secuestros

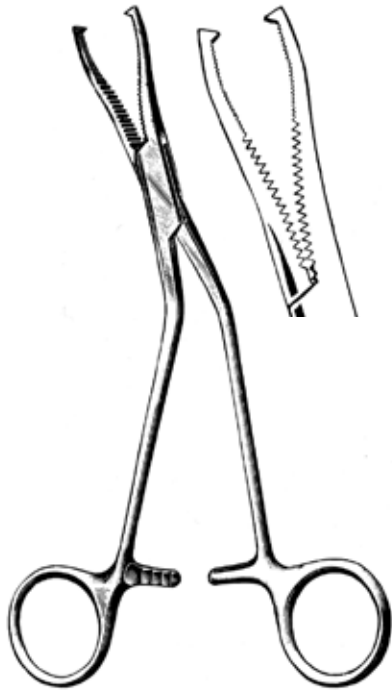

DINGMAN

15-2035.19

19 cm, 7 1/2"



15-2041.13

13,5 cm, 5 1/4"



MARTIN

15-2008.19

19 cm, 7 1/2"



15-2084.20

20 cm, 8"



15-2085.20

20 cm, 8"



VAN BUREN

15-2091.23

23 cm, 9"



LOWMANN

15-2410.13 13 cm, 5"

15-2410.18 18,5 cm, 7 1/4"

15-2410.20 20 cm, 8"

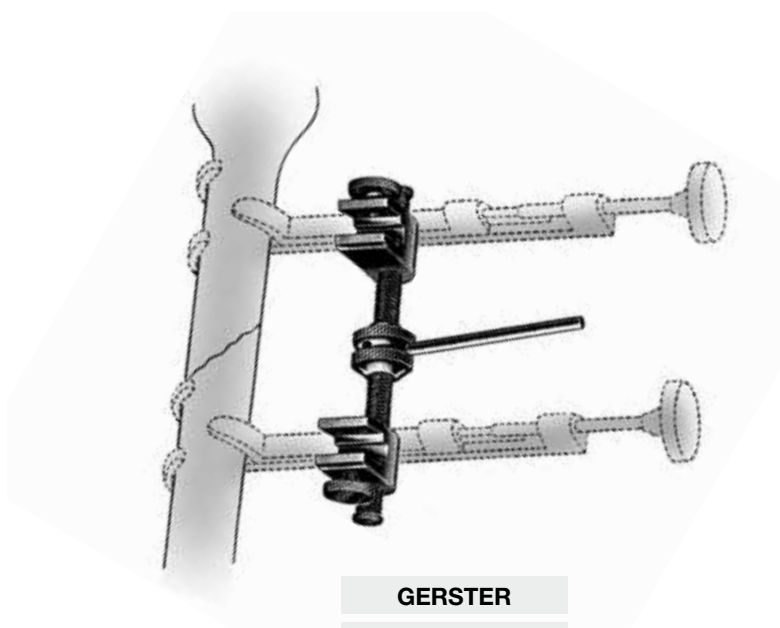

GERSTER

15-2400.15

15 cm, 5 3/4"

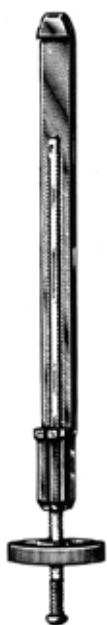

PARHAM

15-2401.00

18 cm, 7"



PARHAM

15-2401.18 18 cm, 7"

15-2401.30 30 cm, 12"



15-2402.01

für Erwachsene
 for adults
 pour adultes
 para adultos

15-2402.02

für Kinder
 for children
 pour enfants
 para niños

Scharfe Löffel
Bone Curettes
Curettes tranchantes
Cucharillas cortantes



Fig 000 Fig 00

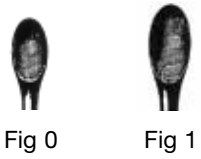

Fig 0 Fig 1



Fig 2



Fig 3



Fig 4

SCHEDE

17 cm, 6 3/4"

15-2017.33	Fig. 000
15-2017.42	Fig. 00
15-2017.50	Fig. 0
15-2017.51	Fig. 1
15-2017.52	Fig. 2
15-2017.53	Fig. 3
15-2017.54	Fig. 4



Fig 0000

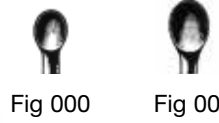

Fig 000 Fig 00



Fig 0 Fig 1

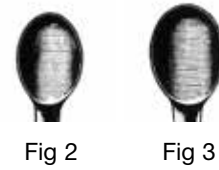

Fig 2 Fig 3



Fig 4



Fig 5



Fig 6

VOLKMANN

17 cm, 6 3/4"

15-2027.24	Fig. 0000
15-2027.33	Fig. 000
15-2027.42	Fig. 00
15-2027.50	Fig. 0
15-2027.51	Fig. 1
15-2027.52	Fig. 2
15-2027.53	Fig. 3
15-2027.54	Fig. 4
15-2027.55	Fig. 5
15-2027.56	Fig. 6



Fig 0000



Fig 000 Fig 00

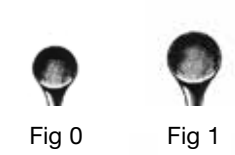

Fig 0 Fig 1



Fig 2 Fig 3



Fig 4



Fig 5



Fig 6

BRUNS

17 cm, 6 3/4"

15-2037.24	Fig. 0000
15-2037.33	Fig. 000
15-2037.42	Fig. 00
15-2037.50	Fig. 0
15-2037.51	Fig. 1
15-2037.52	Fig. 2
15-2037.53	Fig. 3
15-2037.54	Fig. 4
15-2037.55	Fig. 5
15-2037.56	Fig. 6

Scharfe Löffel
Bone Curettes
Curettes tranchantes
Cucharillas cortantes



Fig 000 Fig 00



Fig 0 Fig 1



Fig 2 Fig 3



Fig 4



Fig 5



Fig 6



SPRATT

16 cm, 6 1/4"

15-2046.33	Fig. 000
15-2046.42	Fig. 00
15-2046.50	Fig. 0
15-2046.51	Fig. 1
15-2046.52	Fig. 2
15-2046.53	Fig. 3
15-2046.54	Fig. 4
15-2046.55	Fig. 5
15-2046.56	Fig. 6



Fig 000 Fig 00



Fig 0 Fig 1



Fig 2



Fig 3



Fig 4



Fig 5



Fig 6



BRUNS

23 cm, 9"

15-2096.33	Fig. 000
15-2096.42	Fig. 00
15-2096.50	Fig. 0
15-2096.51	Fig. 1
15-2096.52	Fig. 2
15-2096.53	Fig. 3
15-2096.54	Fig. 4
15-2096.55	Fig. 5
15-2096.56	Fig. 6



Fig 1



Fig 2



Fig 3



Fig 4



Fig 5



Fig 6



SIMON

24 cm, 9 1/2"

15-2144.51	Fig. 1
15-2144.52	Fig. 2
15-2144.53	Fig. 3
15-2144.54	Fig. 4
15-2144.55	Fig. 5
15-2144.56	Fig. 6

Scharfe Löffel
 Bone Currettes
 Curettes tranchantes
 Cucharillas cortantes

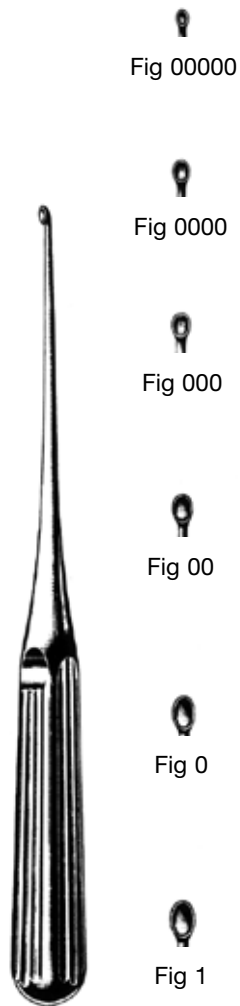

LEMPERT

21 cm, 8 1/4"

15-2171.15	Fig. 00000
15-2171.24	Fig. 0000
15-2171.33	Fig. 000
15-2171.42	Fig. 00
15-2171.50	Fig. 0
15-2171.51	Fig. 1

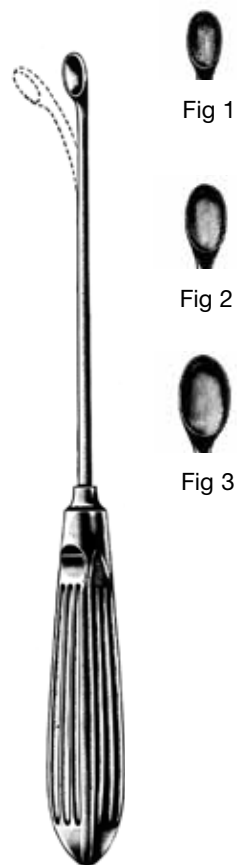

HALLE

21 cm, 8 1/4"

15-2151.01	Fig. 1
15-2151.02	Fig. 2
15-2151.03	Fig. 3

Scharfe Löffel
 Bone Curettes
 Curettes tranchantes
 Cucharillas cortantes



VOLKMANN

15-2314.13	13 cm, 5"
15-2314.16	16 cm, 6 1/4"
15-2314.20	20 cm, 8"



VOLKMANN

15-2310.13	13 cm, 5"
15-2310.14	14 cm, 5 1/2"
15-2310.17	17 cm, 6 3/4"



WILLIGER

13,5 cm, 5 1/4"

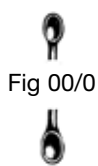

15-2323.00

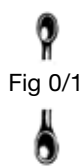

15-2323.01



15-2323.12



MARTINI

13,5 cm, 5 1/4"

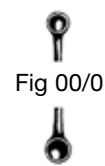

15-2333.00

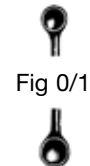

15-2333.01



15-2333.12

Knochenmeißel
Bone Chisels and Gouges
Ciseaux-burins, gouges
Cinceles, gubias



Osteotome
 Osteotomes
 Ostéotomes
 Osteótomos

15-1020.08	8 mm
15-1020.10	10 mm
15-1020.12	12 mm
15-1020.14	14 mm
15-1020.16	16 mm

13,5 cm, 5 1/4"



Flachmeißel
 Chisels
 Ciseaux-burins
 Cinceles

15-1022.08	8 mm
15-1022.10	10 mm
15-1022.12	12 mm
15-1022.14	14 mm
15-1022.16	16 mm

13,5 cm, 5 1/4"



Hohlmeißel
 Gouges
 Gouges
 Gubias

15-1024.08	8 mm
15-1024.10	10 mm
15-1024.12	12 mm
15-1024.14	14 mm
15-1024.16	16 mm

13,5 cm, 5 1/4"



Flachmeißel
 Chisels
 Ciseaux-burins
 Cinceles

15-1112.04	4 mm
15-1112.06	6 mm
15-1112.08	8 mm
15-1112.10	10 mm
15-1112.12	12 mm
15-1112.14	14 mm

ALEXANDER

17 cm, 6 3/4"



Hohlmeißel
 Gouges
 Gouges
 Gubias

15-1114.04	4 mm
15-1114.06	6 mm
15-1114.08	8 mm
15-1114.10	10 mm
15-1114.12	12 mm
15-1114.14	14 mm

ALEXANDER

17 cm, 6 3/4"

Knochenmeißel
Bone Chisels and Gouges
Ciseaux-burins, gouges
Cinceles, gubias

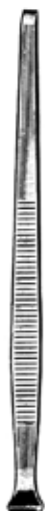

Flachmeißel
 Chisels
 Ciseaux-burins
 Cinceles

15-1062.02	2 mm
15-1062.03	3 mm
15-1062.04	4 mm
15-1062.05	5 mm
15-1062.06	6 mm
15-1062.07	7 mm
15-1062.08	8 mm

PARTSCH

13,5 cm, 5 1/4"

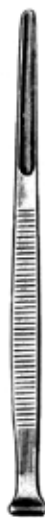

Hohlmeißel
 Gouges
 Gouges
 Gubias

15-1064.02	2 mm
15-1064.03	3 mm
15-1064.04	4 mm
15-1064.05	5 mm
15-1064.06	6 mm
15-1064.07	7 mm
15-1064.08	8 mm

PARTSCH

13,5 cm, 5 1/4"



Flachmeißel
 Chisels
 Ciseaux-burins
 Cinceles

15-1072.02	2 mm
15-1072.03	3 mm
15-1072.04	4 mm
15-1072.05	5 mm
15-1072.06	6 mm
15-1072.07	7 mm
15-1072.08	8 mm

PARTSCH

17 cm, 6 3/4"



Hohlmeißel
 Gouges
 Gouges
 Gubias

15-1074.02	2 mm
15-1074.03	3 mm
15-1074.04	4 mm
15-1074.05	5 mm
15-1074.06	6 mm
15-1074.07	7 mm
15-1074.08	8 mm

PARTSCH

17 cm, 6 3/4"

15

Knochenmeißel
Bone Chisels and Gouges
Ciseaux-burins, gougues
Cinceles, gubias



Osteotome
 Osteotomes
 Ostéotomes
 Osteótomos

15-1130.10	10 mm
15-1130.15	15 mm
15-1130.20	20 mm
15-1130.25	25 mm

STILLE
 20 cm, 8"



Flachmeißel
 Chisels
 Ciseaux-burins
 Cinceles

15-1132.10	10 mm
15-1132.15	15 mm
15-1132.20	20 mm
15-1132.25	25 mm

STILLE
 20 cm, 8"



Hohlmeißel
 Gougues
 Gougues
 Gubias

15-1134.10	10 mm
15-1134.15	15 mm
15-1134.20	20 mm
15-1134.25	25 mm

STILLE
 20 cm, 8"



Osteotome
 Osteotomes
 Ostéotomes
 Osteótomos

15-1150.04	4 mm
15-1150.06	6 mm
15-1150.08	8 mm
15-1150.10	10 mm
15-1150.12	12 mm

MINI-LEXER
 18 cm, 7"



Hohlmeißel
 Gougues
 Gougues
 Gubias

15-1154.04	4 mm
15-1154.06	6 mm
15-1154.08	8 mm
15-1154.10	10 mm
15-1154.12	12 mm

MINI-LEXER
 18 cm, 7"



Osteotome
 Osteotomes
 Ostéotomes
 Osteótomos

15-1156.03	3 mm
15-1156.05	5 mm
15-1156.06	6 mm
15-1156.08	8 mm
15-1156.09	9 mm

HOKE
 17 cm, 6 3/4"

Knochenmeißel
Bone Chisels and Gouges
Ciseaux-burins, gouges
Cinceles, gubias



Osteotome
 Osteotomes
 Ostéotomes
 Osteótomos

15-1160.07	7 mm
15-1160.10	10 mm
15-1160.15	15 mm
15-1160.20	20 mm
15-1160.25	25 mm
15-1160.30	30 mm

LEXER

22 cm, 8 3/4"



Hohlmeißel
 Gouges
 Gouges
 Gubias

15-1164.07	7 mm
15-1164.10	10 mm
15-1164.15	15 mm
15-1164.20	20 mm
15-1164.25	25 mm
15-1164.30	30 mm

LEXER

22 cm, 8 3/4"



Osteotome
 Osteotomes
 Ostéotomes
 Osteótomos

15-1200.03	3 mm
15-1200.04	4 mm
15-1200.06	6 mm
15-1200.08	8 mm
15-1200.10	10 mm
15-1200.12	12 mm
15-1200.15	15 mm

MINI-LAMBOTTE

12,5 cm, 5"



Osteotome
 Osteotomes
 Ostéotomes
 Osteótomos

15-1210.06	6,5 mm
15-1210.15	15 mm
15-1210.20	20 mm
15-1210.25	25 mm
15-1210.30	30 mm
15-1210.38	38 mm
15-1210.44	44 mm

LAMBOTTE

24 cm, 9 1/2"



Osteotome
 Osteotomes
 Ostéotomes
 Osteótomos

15-1211.06	6,5 mm
15-1211.15	15 mm
15-1211.20	20 mm
15-1211.25	25 mm
15-1211.30	30 mm
15-1211.38	38 mm
15-1211.44	44 mm

LAMBOTTE

24 cm, 9 1/2"

15

Knochenmeißel
Bone Chisels and Gouges
Ciseaux-burins, gouges
Cinceles, gubias



Osteotome
 Osteotomes
 Ostéotomes
 Osteótomos

15-1230.06	6 mm
15-1230.09	9 mm
15-1230.10	10 mm
15-1230.13	13 mm
15-1230.16	16 mm
15-1230.19	19 mm
15-1230.25	25 mm
15-1230.32	32 mm

SMITH-PETERSEN

20 cm, 8"



Osteotome
 Osteotomes
 Ostéotomes
 Osteótomos

15-1231.06	6 mm
15-1231.09	9 mm
15-1231.10	10 mm
15-1231.13	13 mm
15-1231.16	16 mm
15-1231.19	19 mm
15-1231.25	25 mm
15-1231.32	32 mm

SMITH-PETERSEN

20 cm, 8"



Hohlmeißel
 Gouges
 Gouges
 Gubias

15-1234.06	6 mm
15-1234.09	9 mm
15-1234.10	10 mm
15-1234.13	13 mm
15-1234.16	16 mm
15-1234.19	19 mm
15-1234.25	25 mm
15-1234.32	32 mm

SMITH-PETERSEN

20 cm, 8"



Osteotome
 Osteotomes
 Ostéotomes
 Osteótomos

15-1250.06	6 mm
15-1250.13	13 mm
15-1250.19	19 mm
15-1250.25	25 mm
15-1250.32	32 mm

HIBBS

24 cm, 9 1/2"



Osteotome
 Osteotomes
 Ostéotomes
 Osteótomos

15-1251.06	6 mm
15-1251.13	13 mm
15-1251.19	19 mm
15-1251.25	25 mm
15-1251.32	32 mm

HIBBS

24 cm, 9 1/2"

Knochenmeißel
Bone Chisels and Gouges
Ciseaux-burins, gouges
Cinceles, gubias



Hohlmeißel
 Gouges
 Gouges
 Gubias

15-1254.06	6 mm
15-1254.13	13 mm
15-1254.19	19 mm
15-1254.25	25 mm
15-1254.32	32 mm

HIBBS

24 cm, 9 1/2"



Hohlmeißel
 Gouges
 Gouges
 Gubias

15-1255.06	6 mm
15-1255.13	13 mm
15-1255.19	19 mm
15-1255.25	25 mm
15-1255.32	32 mm

HIBBS

24 cm, 9 1/2"



Flachmeißel
 Chisels
 Ciseaux-burins
 Cinceles

15-1252.06	6 mm
15-1252.13	13 mm
15-1252.19	19 mm
15-1252.25	25 mm
15-1252.32	32 mm

HIBBS

24 cm, 9 1/2"

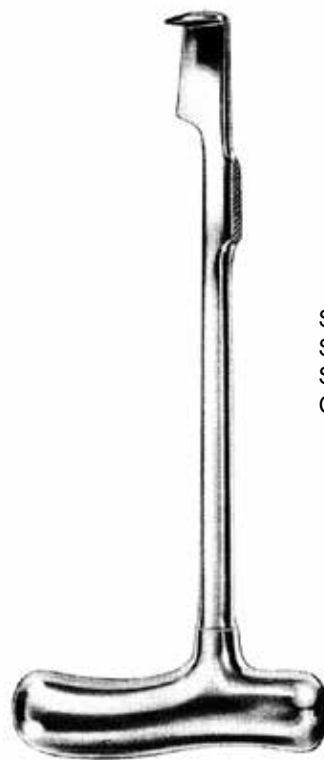

Sternummeißel
 Sternum Chisel
 Sternotome
 Cincel para esternón

LEBSCHKE

15-1654.24

24,5 cm, 9 3/4"

15

Anatomische Meißel
Dissecting Chisels
Ciseaux à dissection
Cinceles de disección



15-1613.22

22 cm, 8 3/4"

Schädelspalter
 Skull Breaker
 Burin pour le crane
 Escoplo para cráneo

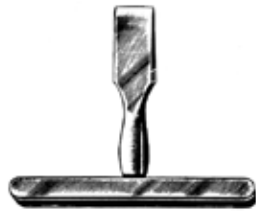

VIRCHOW

15-1620.16



BRUNETTI

15-1628.01

28,5 cm, 11 1/4"



BRUNETTI

15-1628.02

28,5 cm, 11 1/4"

Autopsie-Besteck
 Post Mortem Set
 Set à autopsie
 Juego de autopsia



15-1630.00

Hämmer
 Bone Hammers and Mallets
 Maillets
 Martillos y mazos



GERZOG

15-0219.25

19,5 cm, 7 3/4"

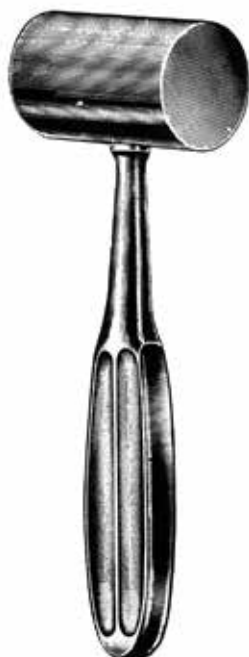

KIRK

15-0221.68

21 cm, 8 1/4"



15-0100.45 450 g

15-0100.90 900 g

340 g



WILLIGER

15-0144.34

24 cm, 9 1/2"



220 g

COLLIN

15-0120.20

20 cm, 8"



260 g

LUCAE

15-0145.26

19 cm, 7 1/2"

15

Hämmer
Bone Hammers and Mallets
Maillets
Martillos y mazos



MEAD
15-0228.32
 17 cm, 6 3/4"



15-0230.25	250 g
15-0230.40	400 g

26 cm, 10 1/4"



QUISLING
15-0231.75



15-0093.23
 23,5 cm, 9 1/4"

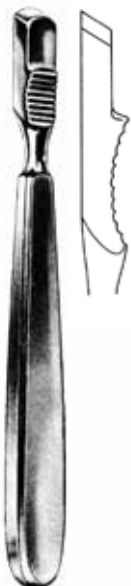

FARABEUF

15-3010.15

15 cm, 6"



FARABEUF

15-3011.15

15 cm, 6"



WILLIGER

15-3116.65

16 cm, 6 1/4"



ALEXANDER

15-3533.16 16 cm, 6 1/4"

15-3533.20 20 cm, 8"



15-3031.10 10 mm

15-3031.15 15 mm

15-3031.20 20 mm

15-3031.25 25 mm

LAMBOTTE

21 cm, 8 1/4"

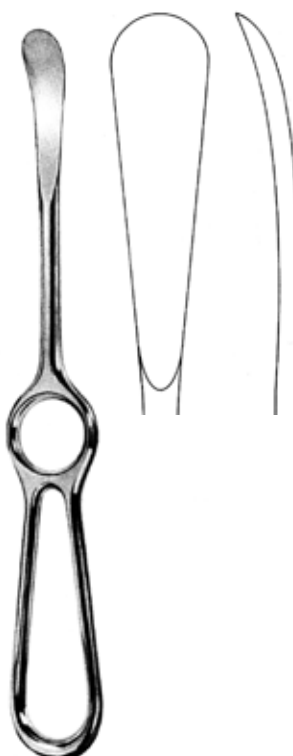

SEDILLOT

15-3171.15

21 cm, 8 1/4"

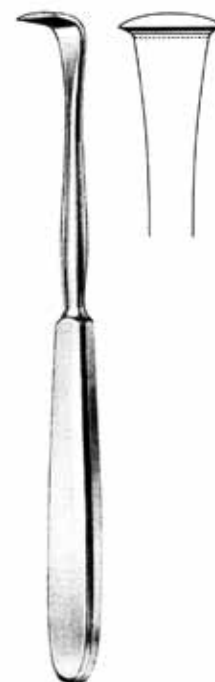

LANGENBECK

15-3021.18

18 cm, 7"

Raspatorien
 Periosteal Elevators
 Rugines-raspatoires
 Periostótomos



DOYEN



15-3510.17

17 cm, 6 3/4"



15-3520.17

17 cm, 6 3/4"



DOYEN



15-3511.17

17 cm, 6 3/4"



15-3521.17

17 cm, 6 3/4"



15-3564.01

17,5 cm, 6 3/4"



15-3564.03

17,5 cm, 6 3/4"



SEMB



15-3564.02

21 cm, 8 1/4"



15-3564.04

21 cm, 8 1/4"



15-3564.05

20,5 cm, 8"



15-3564.06

20,5 cm, 8"



15-3564.07

22,5 cm, 8 3/4"

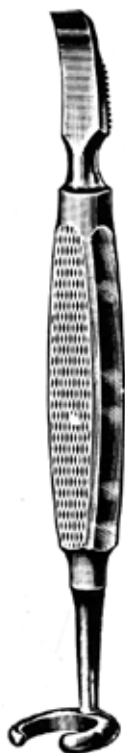

MATSON-ALEXANDER

15-3504.22

22 cm, 8 3/4"



MATSON

15-3505.22

22 cm, 8 3/4"



LANGENBECK

15-4070.20

20 cm, 8"



LANGENBECK

15-4071.20

20 cm, 8"

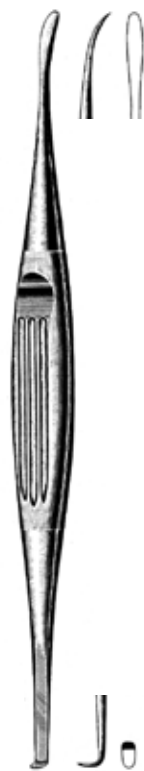

OVERHOLT

15-3529.29

29,5 cm, 11 1/2"



OVERHOLT

15-3540.29

29,5 cm, 11 1/2"



OVERHOLT

15-3541.28

28,5 cm, 11"

Raspatorien, Elevatorien
 Periosteal Elevators, Elevators
 Rugines-raspatoires, Elévateurs
 Periostótomos, Elevadores para huesos



ADSON



15-3057.01

17 cm, 6 3/4"



15-3057.02

17 cm, 6 3/4"



15-3057.03

17 cm, 6 3/4"



15-3057.04

17 cm, 6 3/4"



KEY

19 cm, 7 1/2"

15-4169.06	6 mm
15-4169.12	12 mm
15-4169.19	19 mm
15-4169.25	25 mm



WATSON-CHEYNE

15-4181.17

17,5 cm, 6 3/4"



MC DONALD

15-4183.19

19 cm, 7 1/2"



MURPHY-LANE

15-4185.30

30 cm, 11 3/4"

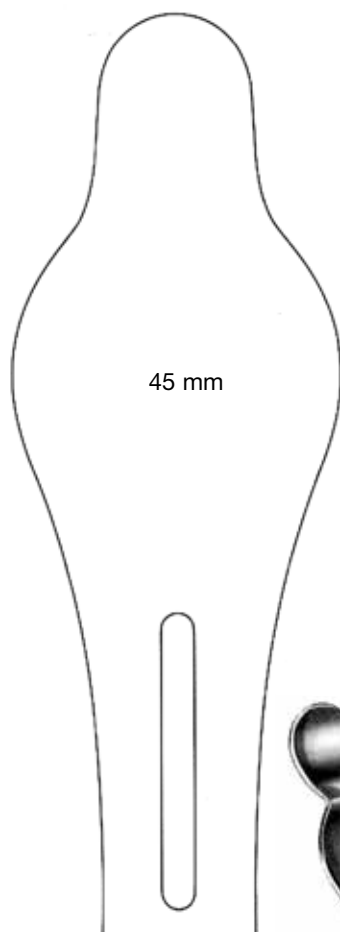

15-1649.45

24,5 cm, 9 3/4"

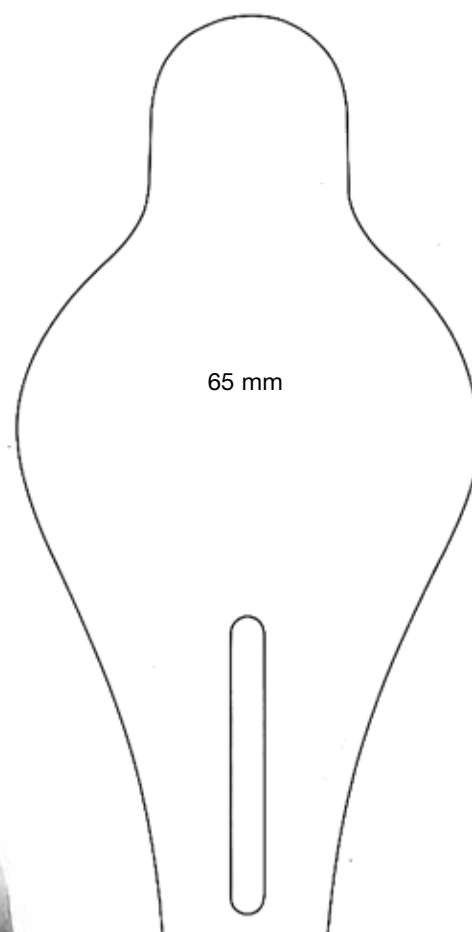

15-1649.65

24,5 cm, 9 3/4"

BENNETT

Knochenheber
Bone Levers
Leviers à os
Elevadores para huesos





HOHMANN
15-1661.43
24,5 cm, 9 3/4"

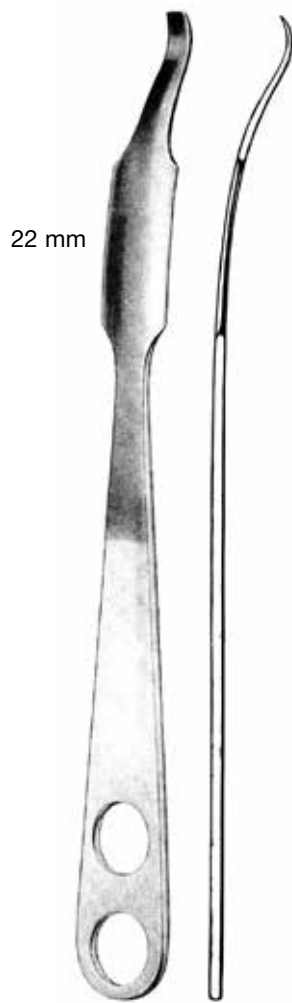

HOHMANN
15-1662.22
26 cm, 10 1/4"

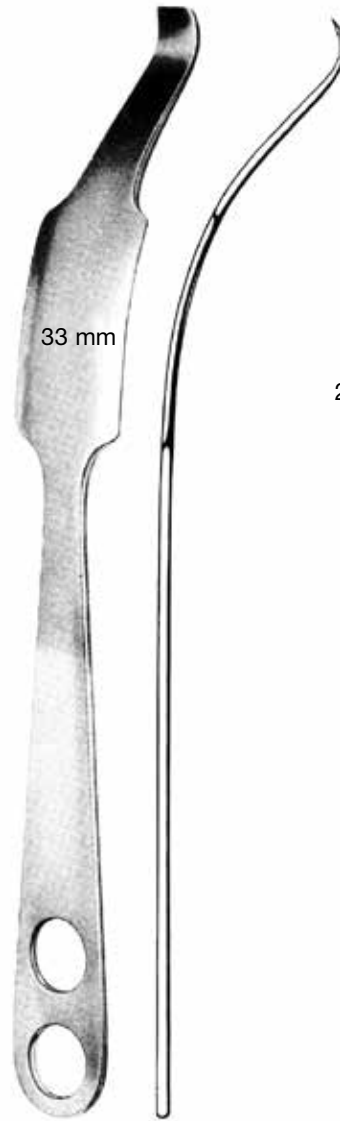

HOHMANN
15-1662.33
28 cm, 11"

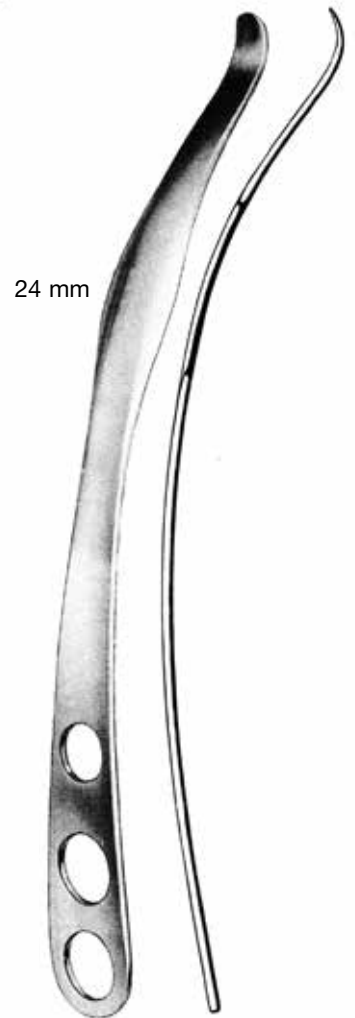

HOHMANN
15-1664.24
26,5 cm, 10 1/2"

Knochenheber
Bone Levers
Leviers à os
Elevadores para huesos

22 mm

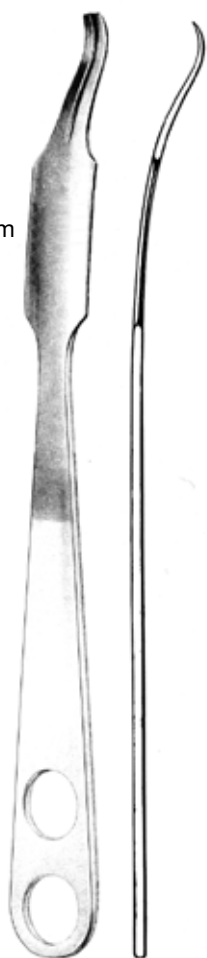

HOHMANN

15-1665.22

26 cm, 10 1/4"

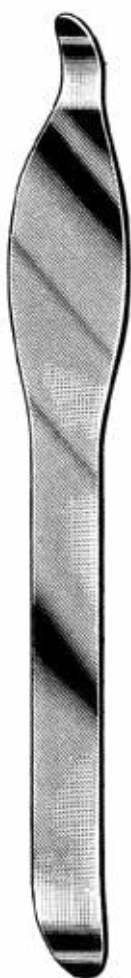

BLOUNT

15-1630.26

26 cm, 10 1/4"

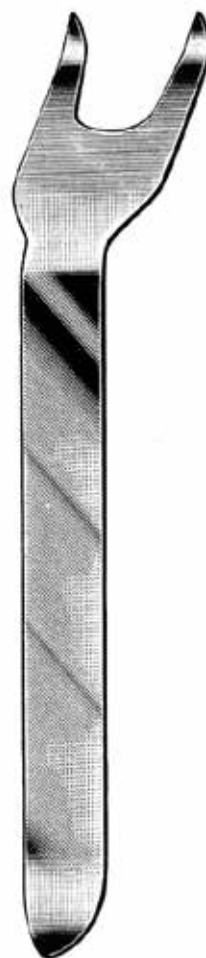

BLOUNT

15-1631.26

26 cm, 10 1/4"

Knochenheber
Bone Levers
Leviers à os
Elevadores para huesos



15-1625.60

14 cm, 5 1/2"



MINI-HOHMANN

6 mm



15-1636.60

16 cm, 6 1/4"

8 mm



15-1636.80

16 cm, 6 1/4"



TAYLOR

15-1635.16 75 x 30 mm

15-1637.16 100 x 30 mm

16,5 cm, 6 1/2"

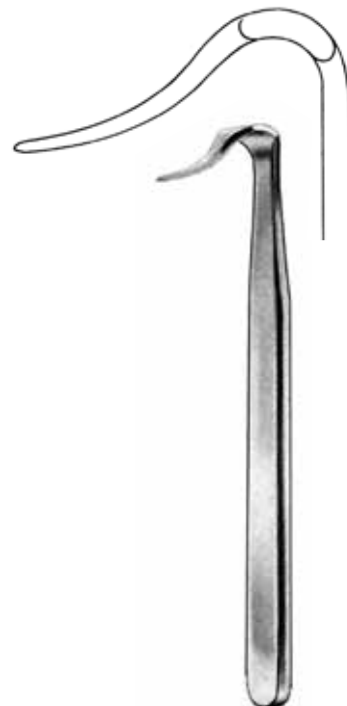

BLOUNT

15-1633.17

17,5 cm, 7"

15

Meniskusmesser
Meniscotomes
Meniscotomes
Meniscótomos

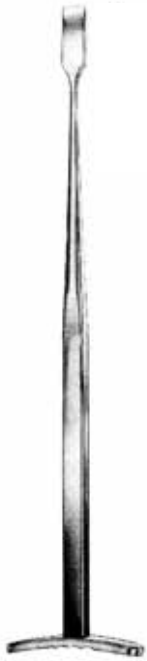

SMILLIE



15-1638.01

17 cm, 6 3/4"



15-1638.02

17 cm, 6 3/4"

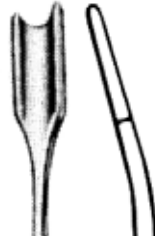

15-1638.03

17 cm, 6 3/4"



BIRCHER-GANSKE

15-1639.19

19 cm, 7 1/2"



BIRCHER-GANSKE

15-1640.19

19 cm, 7 1/2"



NEFF

15-1641.22

22 cm, 8 1/2"



NEFF

15-1642.22

22 cm, 8 1/2"

Sehnenstripper, Knochenfeilen
Tendon Strippers, Bone Files
Instruments à écorcher les tendons, limes à os
Separadores para tendones, limas para huesos



15-1644.01

Fig. 1



15-1644.02

Fig. 2



15-1644.03

Fig. 3



15-1644.04

Fig. 4



15-1644.05

Fig. 5



BUNNEL

15 cm, 5 3/4"



15-1650.22

22 cm, 8 1/2"



15-1651.24

24,5 cm, 9 3/4"



PUTTI

15-1655.27

27 cm, 10 1/2"



15-1657.30

30 cm, 11 3/4"





16-0206.00

Komprimeter
Compression Apparatus
Appareil compressif
Aparato de compresión

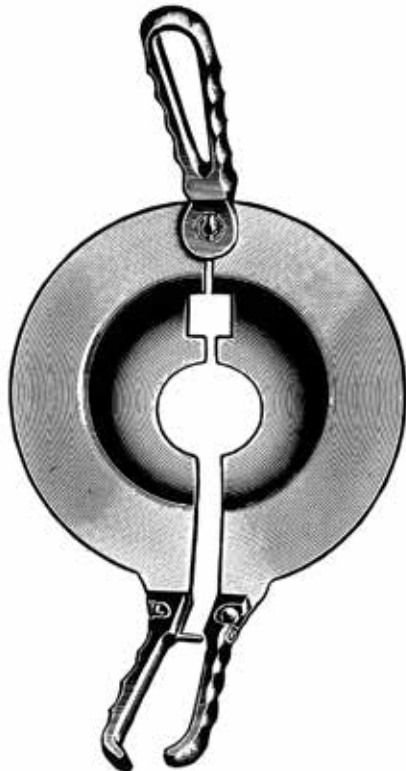

PERCY

16-1100.00

Amputationsretraktor
Amputation Retractor
Rétracteur pour amputation
Retractor para amputación

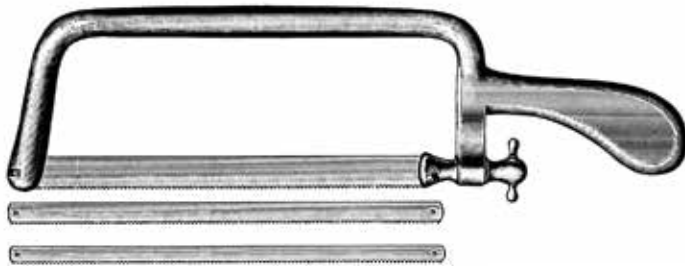

CHARRIERE

16-1250.00

komplett mit 2 Sägeblättern
complete with 2 saw blades
complète avec 2 lames de scie
completo con 2 hojas de sierra



16-1250.03

3 mm



16-1250.05

5 mm



16-1250.07

7 mm



CHARRIERE

16-1230.30

30 cm, 12"

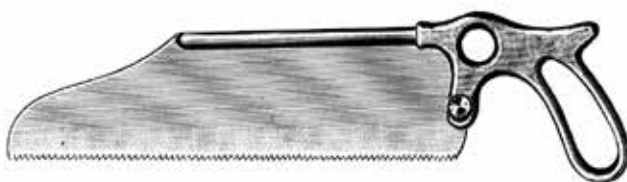

SATTERLEE

16-1235.31

31 cm, 12 1/2"



LANGENBECK

16-1677.23

23 cm, 9"



16-1678.00

komplett mit 3 Bohrern
complete with 3 drill points
complète avec 3 vrilles
completo con 3 brocas



16-1678.01

3 Bohrer, Set
3 drill points, set
3 vrilles, jeu
3 brocas, juego



RADOLF

16-1679.13

13,5 cm, 5 1/4"



16-1680.00



16-1680.01

Fingerringsäge
Finger ring saw
Scie pour bagues
Sierra para abrir anillos

Handbohrapparate
Bone Hand Drills
Perforateurs à main
Perforadores a mano

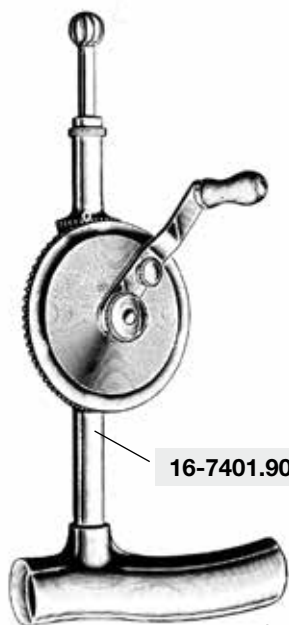

16-7401.90

STILLE

16-7401.00

komplett
 complete
 complète
 completo



16-7401.25

2,5 mm



16-7401.30

3,0 mm



16-7401.35

3,5 mm



16-7401.40

4,0 mm



16-7401.05

5,0 mm



16-7401.08

8,0 mm



16-7401.10

10,0 mm



16-7401.12

12,0 mm



16-7401.16

16,0 mm



16-7402.10

1,0 mm



16-7402.15

1,5 mm



16-7402.20

2,0 mm

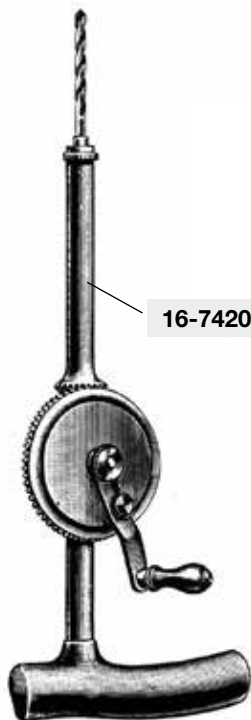

16-7420.90

STILLE-SHERMANN

16-7420.00

komplett
 complete
 complète
 completo

24 cm, 9 1/2"



16-7420.25

2,5 mm



16-7420.30

3,0 mm



16-7420.35

3,5 mm

Handbohrapparate
Bone Hand Drills
Perforateurs à main
Perforadores a mano

16



16-7410.90

MOORE

16-7410.00

24 cm, 9 1/2"

komplett
 complete
 complète
 completo

9,0 mm



7,5 mm 7,0 mm



16-7410.30

3 Bohrer, Set,
 3 drill points, set
 3 vrilles, jeu
 3 brocas, juego



CUSHING

16-7431.14

14,0 mm



MC KENZIE

16-7433.00

13,0 mm



HUDSON

16-7430.00

27 cm, 10 3/4"

komplett
 complete
 complète
 completo



16-7430.09

9,0 mm



16-7430.14

14,0 mm



16-7430.16

16,0 mm



16-7430.22

22,0 mm



16-7432.00

Handbohrapparate
Bone Hand Drills
Perforateurs à main
Perforadores a mano



KIRSCHNER
16-7440.00



16-7441.00

komplett
 complete
 complète
 completo



KIRSCHNER
16-7450.00



16-7451.00

komplett
 complete
 complète
 completo

Handbohrapparate
Bone Hand Drills
Perforateurs à main
Perforadores a mano

16



16-7500.92

Spannschlüssel
 Key
 Clef
 Llave

BUNNELL

16-7500.16



RALK

16-7510.20

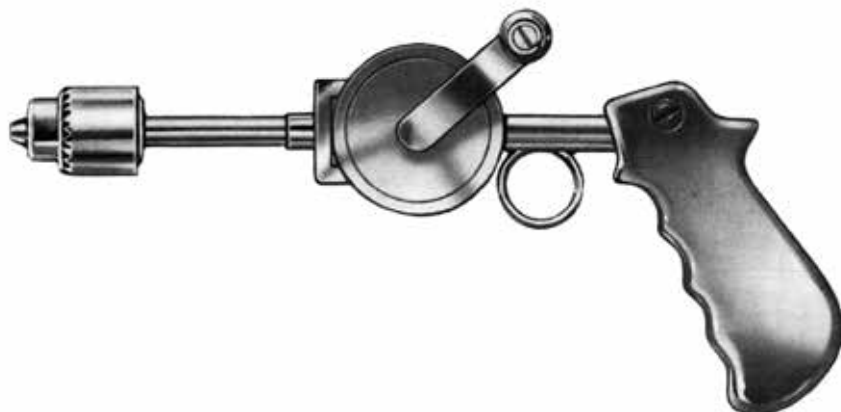

16-7520.00



16-7521.00



16-7533.00

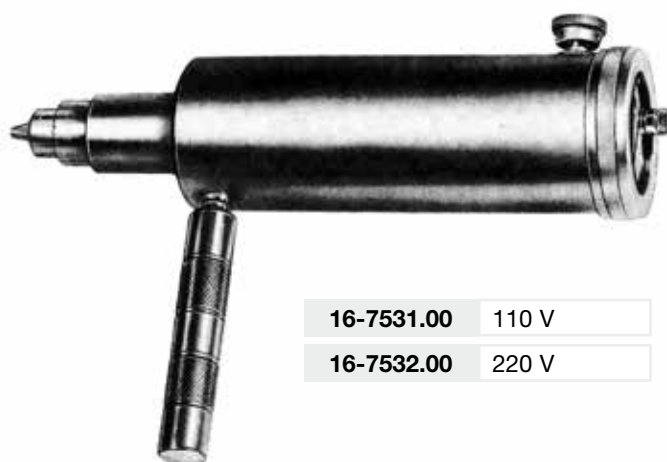

16-7531.00 110 V

16-7532.00 220 V

Bohrer, Fräser, Trephinen
Burrs, Drills, Trephines
Mèches, fraises, trépan
Taladros, fresas, trefinas



16-7550.20	2,0 mm
16-7550.25	2,5 mm
16-7550.30	3,0 mm
16-7550.32	3,2 mm
16-7550.35	3,5 mm
16-7550.40	4,0 mm
16-7550.50	5,0 mm
16-7550.60	6,0 mm
16-7550.70	7,0 mm



16-7552.10	1,0 mm
16-7552.12	1,2 mm
16-7552.15	1,5 mm
16-7552.18	1,8 mm
16-7552.20	2,0 mm
16-7552.22	2,2 mm
16-7552.25	2,5 mm
16-7552.28	2,8 mm
16-7552.30	3,0 mm
16-7552.32	3,2 mm
16-7552.35	7,0 mm
16-7552.40	4,0 mm
16-7552.50	5,0 mm



16-7554.10	1,0 mm
16-7554.15	1,5 mm
16-7554.20	2,0 mm
16-7554.25	2,5 mm
16-7554.28	2,8 mm
16-7554.30	3,0 mm
16-7554.32	3,2 mm
16-7554.35	3,5 mm
16-7554.40	4,0 mm
16-7554.50	5,0 mm
16-7554.60	6,0 mm



16-7562.04	4,0 mm
16-7562.06	6,0 mm
16-7562.08	8,0 mm
16-7562.10	10,0 mm
16-7562.12	12,0 mm
16-7562.14	14,0 mm
16-7562.16	16,0 mm

DOYEN



16-7564.04	4,0 mm
16-7564.06	6,0 mm
16-7564.08	8,0 mm
16-7564.10	10,0 mm
16-7564.12	12,0 mm
16-7564.14	14,0 mm
16-7564.16	16,0 mm

DOYEN



16-7572.08	8,0 mm
16-7572.10	10,0 mm
16-7572.12	12,0 mm

ALBEE



DOYEN
16-7566.12
12,0 mm



16-7568.08 8,0 mm
16-7568.10 10,0 mm



DOYEN
16-7570.12 12,0 mm
16-7570.15 15,0 mm



ALBEE

16-7574.07

7,0 mm



BORCHARDT

16-7576.13

13,0 mm



16-7577.25

25,0 mm



TOTI

16-7578.08

8,0 mm



16-7592.14

14 cm, 5 1/2"



PERTHES

16-7595.21

21 cm, 8 1/4"

Zubehör zum Handmotor
Accessories for Bone Engine
Accessoires pour moteur à main
Accesorios para motor a mano



16-7580.20	20 mm
16-7580.25	25 mm
16-7580.30	30 mm
16-7580.35	35 mm
16-7580.40	40 mm
16-7580.45	45 mm
16-7580.50	50 mm



16-7582.20	20 mm
16-7582.25	25 mm
16-7582.30	30 mm
16-7582.35	35 mm
16-7582.40	40 mm
16-7582.45	45 mm
16-7582.50	50 mm

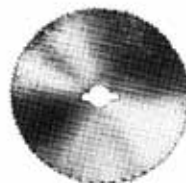

16-7584.20	20 mm
16-7584.25	25 mm
16-7584.30	30 mm
16-7584.35	35 mm
16-7584.40	40 mm
16-7584.45	45 mm
16-7584.50	50 mm

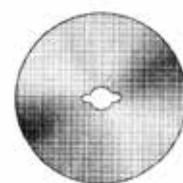

16-7586.17	17 mm
16-7586.22	22 mm
16-7586.27	27 mm
16-7586.32	32 mm
16-7586.37	37 mm
16-7586.42	42 mm
16-7586.47	47 mm



16-7587.00



16-7588.00



16-7590.00

Bohrdrähte
Wire Drills
Broches filiformes
Taladros filiformes



	60 mm	120 mm	140 mm	160 mm	310 mm
Ø 1,0 mm	16-7606.10	16-7612.10	16-7614.10	16-7616.10	16-7631.10
Ø 1,2 mm	16-7606.12	16-7612.12	16-7614.12	16-7616.12	16-7631.12
Ø 1,4 mm	16-7606.14	16-7612.14	16-7614.14	16-7616.14	16-7631.14
Ø 1,5 mm	16-7606.15	16-7612.15	16-7614.15	16-7616.15	16-7631.15
Ø 1,6 mm	16-7606.16	16-7612.16	16-7614.16	16-7616.16	16-7631.16
Ø 1,8 mm	16-7606.18	16-7612.18	16-7614.18	16-7616.18	16-7631.18
Ø 2,0 mm	16-7606.20	16-7612.20	16-7614.20	16-7616.20	16-7631.20
Ø 2,2 mm	16-7606.22	16-7612.22	16-7614.22	16-7616.22	16-7631.22
Ø 2,5 mm				16-7616.25	16-7631.25

KIRSCHNER



310 mm	
16-7632.10	Ø 1,0 mm
16-7632.12	Ø 1,2 mm
16-7632.15	Ø 1,5 mm
16-7632.16	Ø 1,6 mm
16-7632.18	Ø 1,8 mm
16-7632.20	Ø 2,0 mm
16-7632.22	Ø 2,2 mm
16-7632.25	Ø 2,5 mm

KIRSCHNER



16-7690.13	13 cm, 5"
16-7690.14	14 cm, 5 1/2"
16-7690.15	15 cm, 5 3/4"
16-7690.16	16 cm, 6 1/4"
16-7690.18	18 cm, 7"
16-7690.20	20 cm, 8"
16-7690.21	21 cm, 8 1/4"

STEINMANN

Extensionsbügel
Extension Bows
Etriers à extension
Estribos para extensión

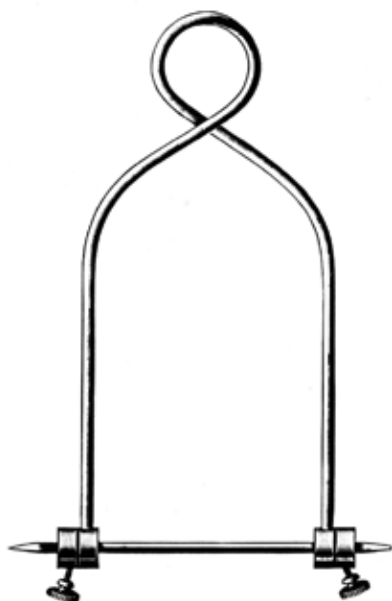

BOEHLER

16-7702.16 160 x 90 mm

16-7702.21 160 x 110 mm

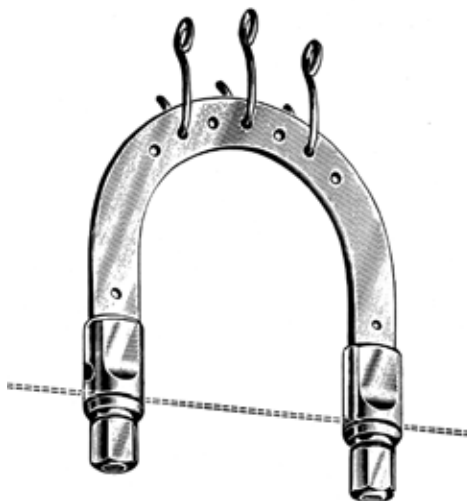

KIRSCHNER

16-7712.09 95 x 70 mm

16-7712.10 105 x 105 mm

16-7712.12 120 x 120 mm

16-7712.15 155 x 155 mm

16-7712.20 200 x 155 mm



16-7714.18 180 x 100 mm

16-7714.27 270 x 160 mm

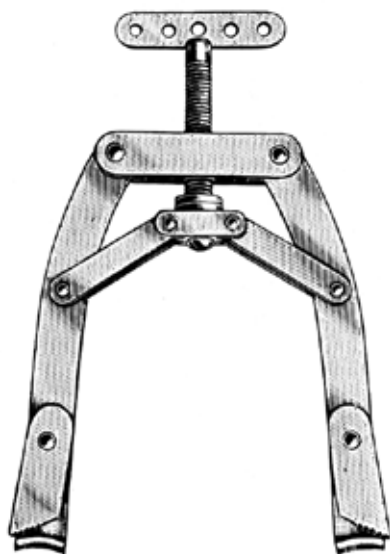

KIRSCHNER

16-7718.01 klein / small

16-7718.02 groß / big



16-7715.01

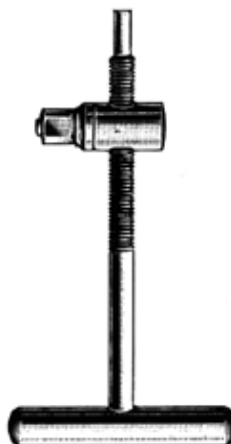

16-7716.02



16-7719.01



16-7719.02



16-7530.02	0,2 mm
16-7530.03	0,3 mm
16-7530.04	0,4 mm
16-7530.05	0,5 mm
16-7530.06	0,6 mm
16-7530.07	0,7 mm
16-7530.08	0,8 mm
16-7530.09	0,9 mm
16-7530.10	1,0 mm
16-7530.11	1,1 mm
16-7530.12	1,2 mm
16-7530.15	1,5 mm

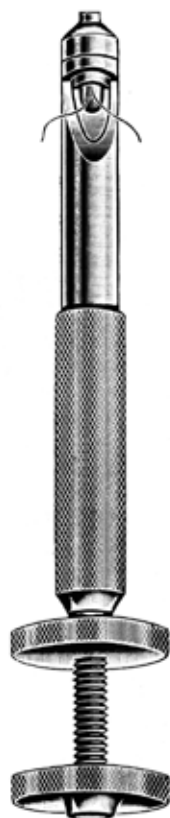

LOUTE

16-7531.21

21 cm, 8 1/4"



16-7533.18

18 cm, 7"



16-7532.17

17 cm, 6 3/4"



16-7534.15

15 cm, 5 3/4"



16-7536.14

14 cm, 5 1/2"



16-7540.16

16 cm, 6 1/4"



16-7542.15

15 cm, 5 3/4"



16-7545.22

22 cm, 8 1/2"



16-7560.24 2,4 mm

16-7560.32 3,2 mm

16-7560.48 4,8 mm

16-7560.64 6,4 mm



16-7562.24 2,4 mm

16-7562.32 3,2 mm

16-7562.48 4,8 mm

16-7562.64 6,4 mm

Knochnagelung
Bone Nailing
Enclouage des os
Enclavamiento de huesos

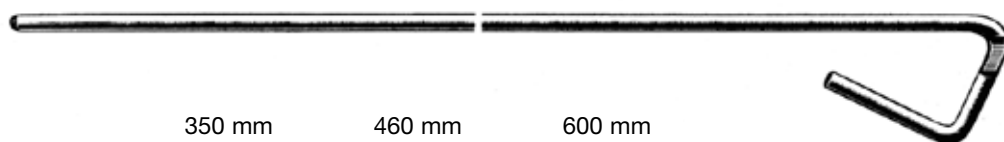

	350 mm	460 mm	600 mm
Ø 2,5 mm	16-7981.25	16-7982.25	
Ø 3,0 mm	16-7981.30	16-7982.30	
Ø 3,5 mm	16-7981.35	16-7982.35	16-7983.35
Ø 4,0 mm	16-7981.40	16-7982.40	16-7983.40
Ø 5,0 mm	16-7981.50	16-7982.50	
Ø 6,0 mm			16-7983.60



KUENTSCHER

16-7971.26

26 cm, 10 1/4"



KUENTSCHER

16-7973.35

35 cm, 13 1/2"



KUENTSCHER

16-7986.21

21 cm, 8 1/4"



KUENTSCHER

16-7988.21

21 cm, 8 1/4"



KUENTSCHER
16-7990.00
 63 cm, 25"



16-7990.01
 Fig.1



16-7990.02
 Fig.2



16-7990.03
 Fig.3



16-7990.04
 Fig.4

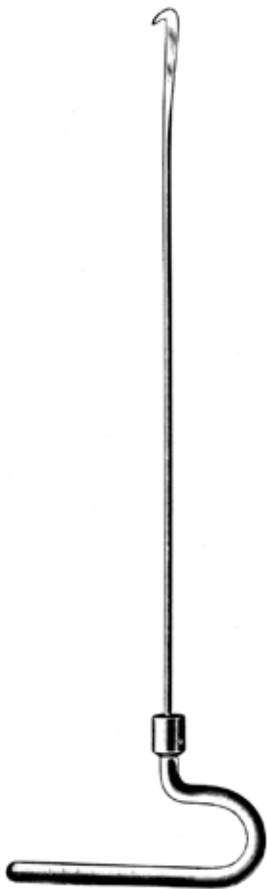

16-7996.29	29 cm, 11 1/4"
16-7996.37	37 cm, 14 1/2"
16-7996.42	42 cm, 15"
16-7996.49	49 cm, 19 1/2"



16-7998.30
 30 cm, 12"

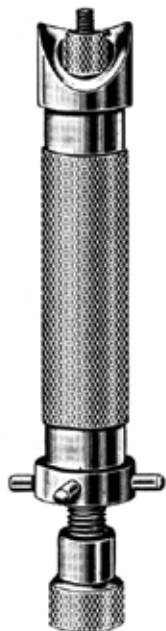

LLOYD

16-7602.20

20 cm, 8"



LANE

16-7620.25

25 cm, 10"



LANE

16-7622.25

25 cm, 10"



WILLIAMS

16-7624.24

24 cm, 9 1/2"



16-7628.25 2,5 mm

16-7628.35 3,5 mm



LANE

16-7635.18

18 cm, 7"



LANE

16-7635.23

23 cm, 9"



LANE

16-7639.22

22 cm, 8 1/2"



16-7680.45 4,5 mm

16-7680.70 7,0 mm



16-7681.05

5,0 mm

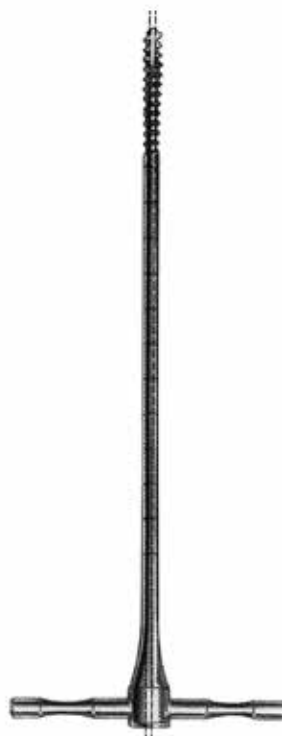

16-7682.45 4,5 mm

16-7682.70 7,0 mm



16-7683.25 2,5 mm

16-7683.35 3,5 mm

16-7683.50 5,0 mm

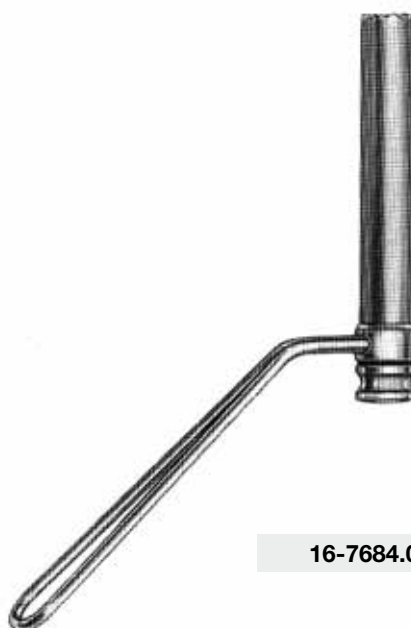

16-7684.00

Osteosynthese
Osteosynthesis
Ostéosynthèse
Osteosíntesis

16



Pages 244-266

Wenn Sie Informationen zu unseren Knochenchirurgieprodukten
wünschen, kontaktieren Sie uns bitte über
info@rolan-instruments.de.

For information regarding Bone Surgery products,
please contact your local distributor or ROLAN directly on
info@rolan-instruments.de.

Para obtener información sobre los productos de Cirugía Ósea,
póngase en contacto con su distribuidor local o ROLAN directamente en
info@rolan-instruments.de.

Pour plus d'informations sur les produits de chirurgie osseuse,
veuillez contacter votre distributeur local ou ROLAN directement sur
info@rolan-instruments.de.



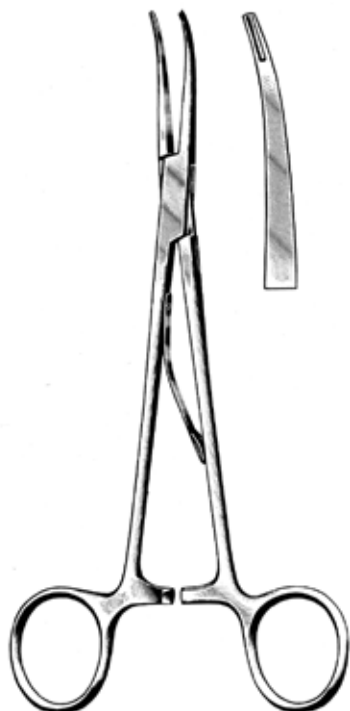

MC KENZIE

18-1011.15 15 cm, 5 3/4"

18-1011.19 19 cm, 7 1/2"

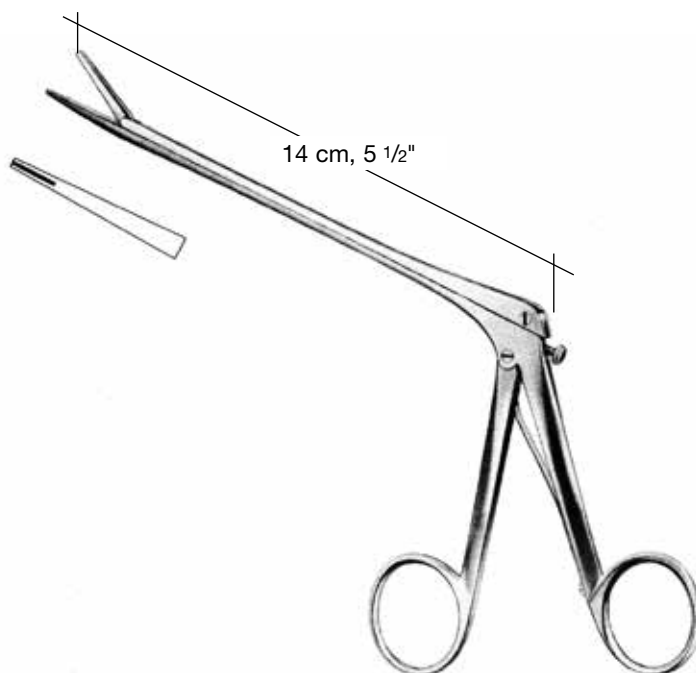

OLIVECRONA-TOENNIS

18-1019.14

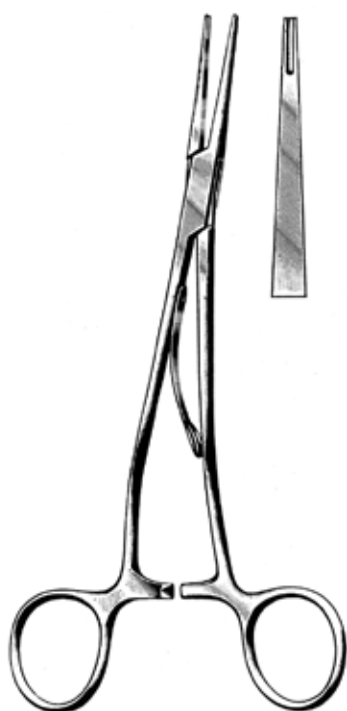

MC KENZIE

18-1013.15 15 cm, 5 3/4"

18-1013.19 19 cm, 7 1/2"

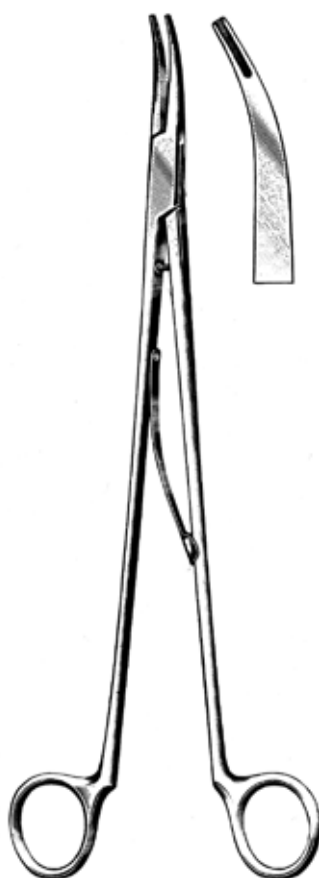

SMITHWICK

18-1015.23 23 cm, 9"

18-1015.26 26 cm, 10 1/4"

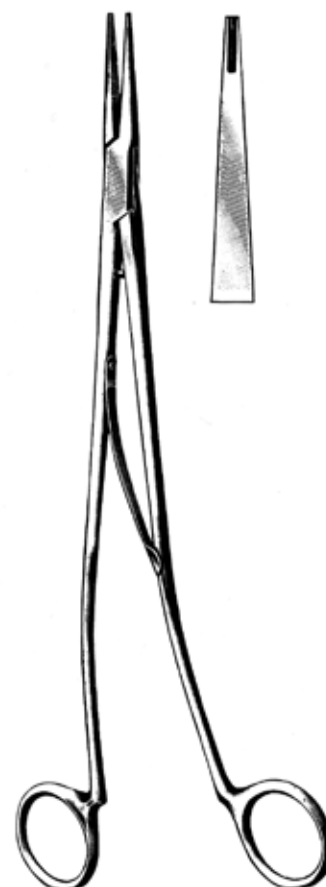

SWEET

18-1017.23 23 cm, 9"

18-1017.26 26 cm, 10 1/4"

Naht, Schädelhalter
Suture, Cervical Traction Tongs
Suture, Pinces de traction cranienne
Sutura, Pinzas de tracción cranial



18-1020.00

148 x 40 x 6 mm

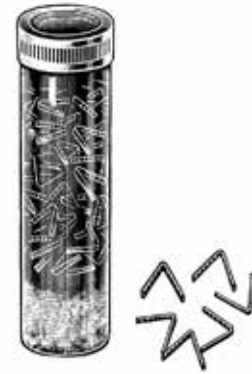

18-1021.00

100 Stück / Pieces / Pièces / Piezas



Kopfhautklammer, -anlegezange
 Scalp Hemostasis Clip, Applying Forceps
 Pince hémostatique pour le cuir chevelu, pince à poser
 Pinza hemostática para cuero cabelludo, pinza para poner



RANEY

18-1028.00

RANEY

18-1027.00

3,5 mm



CRUTCHFIELD

18-1026.35

5,0 mm



CRUTCHFIELD

18-1026.50

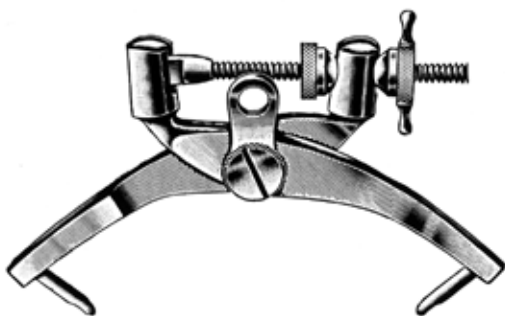

CRUTCHFIELD

18-1025.01



CRUTCHFIELD

18-1025.02

Nervhaken
Nerve Retractors
Ecarteurs á nerfs
Separadores para nervios



DANDY

18-1051.20

20 cm, 8"



DANDY

18-1052.20

20 cm, 8"



DANDY

18-1053.20

20 cm, 8"



GRAHAM

18-1061.16

16,5



CUSHING

Ø 4 mm

18-1056.19

19 cm, 7½ "

18-1056.28

28 cm, 11"



CUSHING

Ø 6 mm

18-1058.19

19 cm, 7½ "

18-1058.28

28 cm, 11"



ADSON

18-1068.20

20 cm, 8"



ADSON

18-1069.20

20 cm, 8"

Nervhaken
Nerve Retractors
Ecarteurs á nerfs
Separadores para nervios



LOVE

18-1080.19

19 cm, 7 1/2"

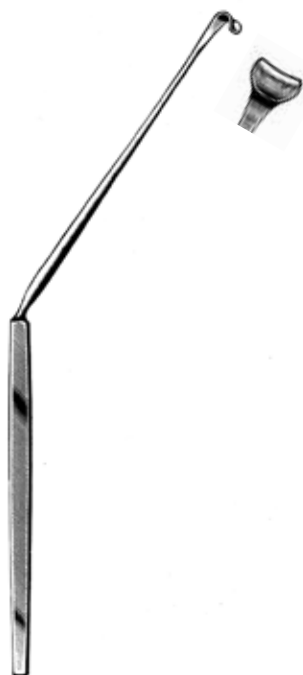

LOVE

18-1081.19

19 cm, 7 1/2"

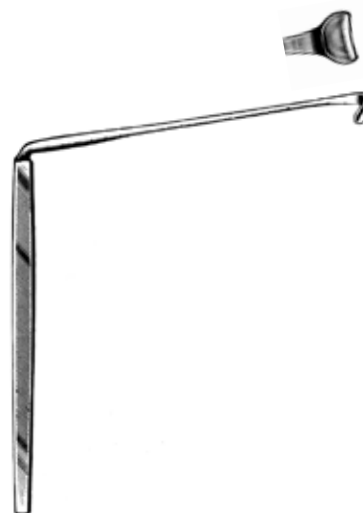

LOVE

18-1083.19

19 cm, 7 1/2"



SACHS

18-1064.18

18,5 cm, 7 1/4"



SMITHWICK

18-1070.29

29 cm, 11 1/4"

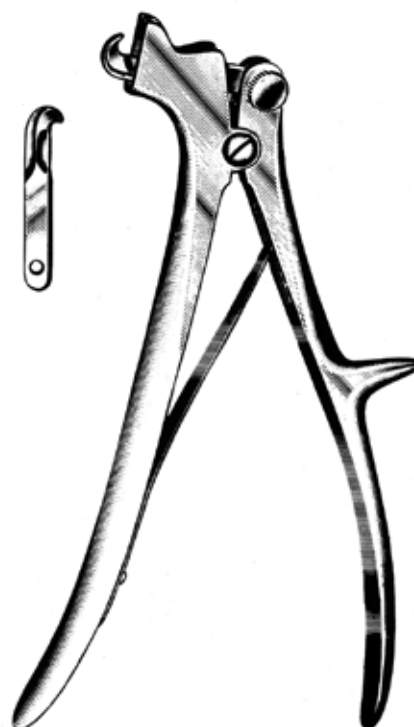

DE VILBISS

18-1096.21

21 cm, 8 1/4"



DE MARTEL

18-1090.33

33 cm, 13"



OLIVECRONA

18-1092.30 30 cm

18-1092.40 40 cm

18-1092.50 50 cm

18-1092.60 60 cm

18-1092.70 70 cm

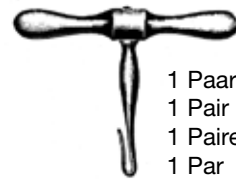

1 Paar
1 Pair
1 Paire
1 Par

GIGLI

18-1094.00



TOENNIS

18-1141.25

25 cm, 10"



SACHS

18-1143.21

21 cm, 8 1/4"



SACHS

18-1145.21

21 cm, 8 1/4"



MILLIGAN

18-1147.21

21 cm, 8 1/4"

Dissektoren
Dissectors
Dissecteurs
Disectores



18-1149.22

22 cm, 8 1/2"

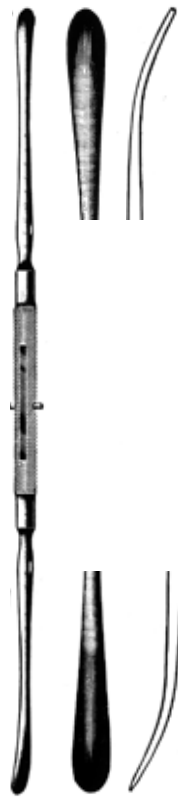

DAVIS

18-1151.24

24 cm, 9 1/2"

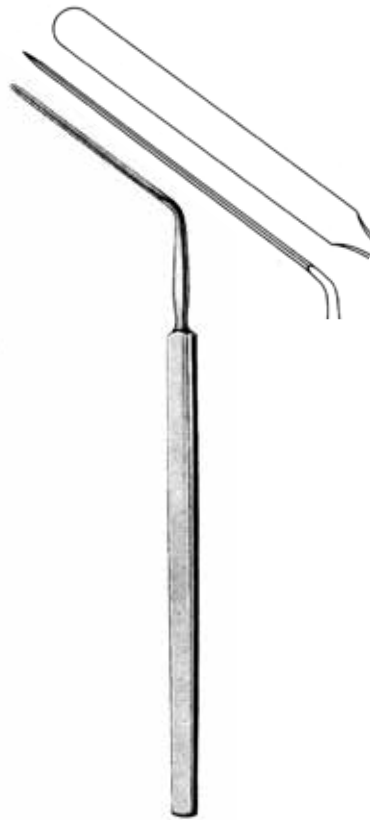

HORSLEY

18-1155.20

20 cm, 8"



PENFIELD

18-1161.01

17,5 cm, 7"



PENFIELD

18-1161.02

19,5 cm, 7 3/4"



PENFIELD

18-1161.03

19,5 cm, 7 3/4"



HALLE

18-1170.20

20 cm, 8"



ADSON
18-1210.23
 23 cm, 9"



ADSON
18-1211.23
 23 cm, 9"



ADSON
18-1213.23
 23 cm, 9"



CUSHING

18-1250.07	7/9 mm
18-1250.11	11/13 mm
18-1250.15	15/18 mm
18-1250.18	18/22 mm



OLIVECRONA

18-1253.07	7/9 mm
18-1253.11	11/13 mm
18-1253.15	15/18 mm
18-1253.18	18/22 mm



HEIFETZ

18-1260.08	8 mm
18-1260.11	11 mm
18-1260.14	14 mm
18-1260.17	17 mm

Saugrohre, Wirbelkörperspreizer
Suction Tubes, Lamina Spreaders
Tubes d'aspiration, Ecarteurs pour corps vertébraux
Tubos de aspiración, Separadores para cuerpos vertebrales



Ø 4,0 mm

ADSON

18-1290.21

21 cm, 8 1/4"



FRAZIER

18-1298.12

12 cm, 4 3/4"



FRAZIER

30°	
18-1295.06	Charr. 6
18-1295.07	Charr. 7
18-1295.08	Charr. 8
18-1295.09	Charr. 9
18-1295.10	Charr. 10
18-1295.11	Charr. 11
18-1295.12	Charr. 12

75°	
18-1297.06	Charr. 6
18-1297.07	Charr. 7
18-1297.08	Charr. 8
18-1297.09	Charr. 9
18-1297.10	Charr. 10
18-1297.11	Charr. 11
18-1297.12	Charr. 12



CLOWARD

18-1301.16

16 cm, 6 1/4"



INGE

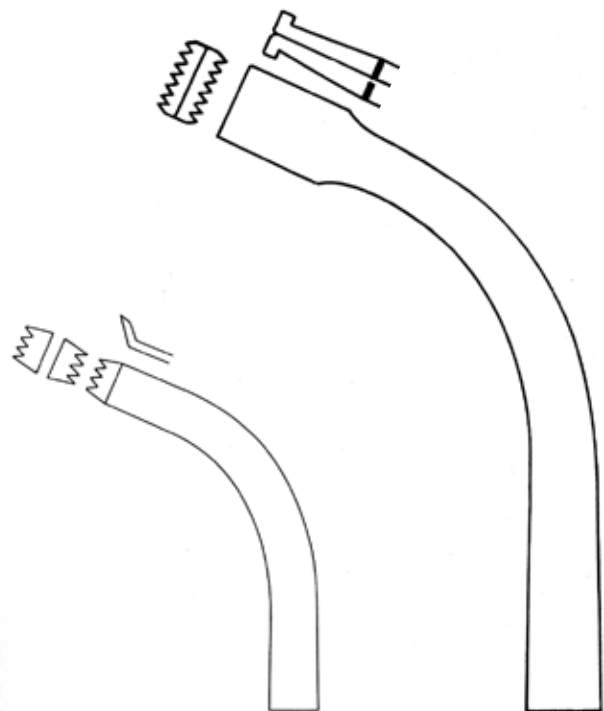

18-1305.17

17 cm, 6 3/4"

18-1305.27

27 cm, 10 1/2"

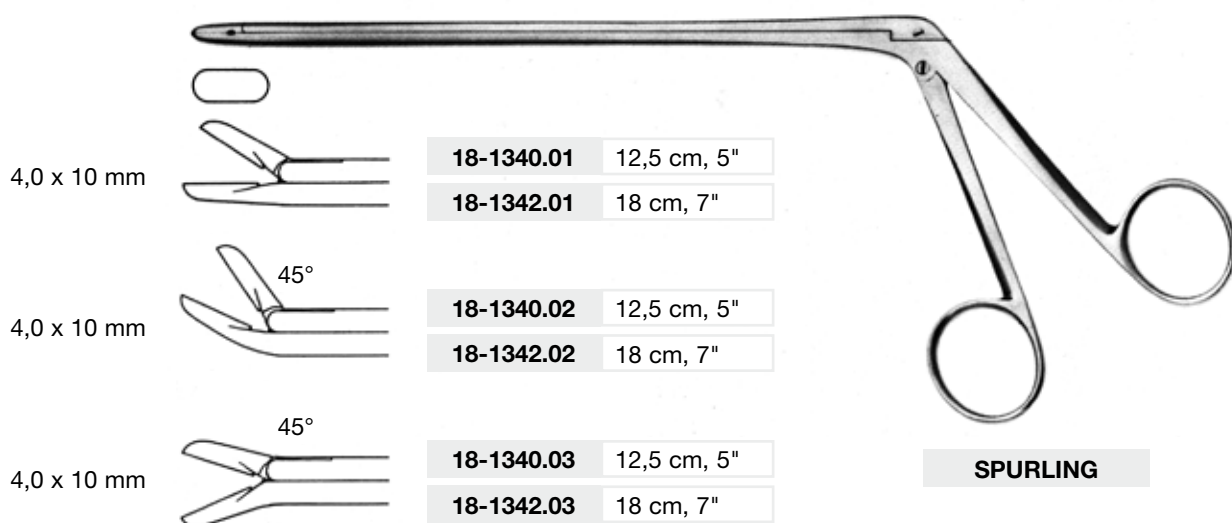
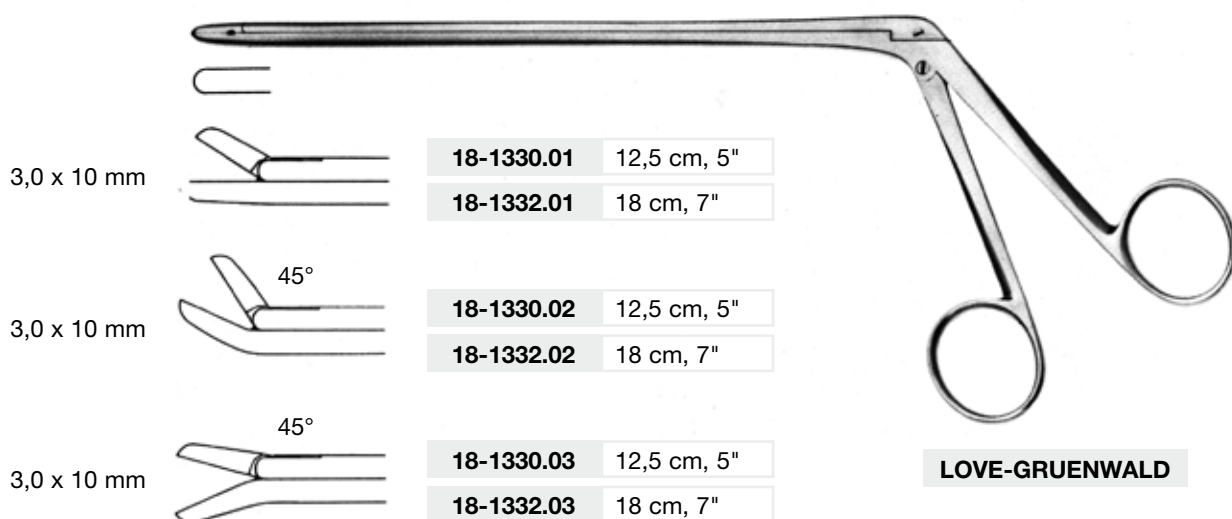
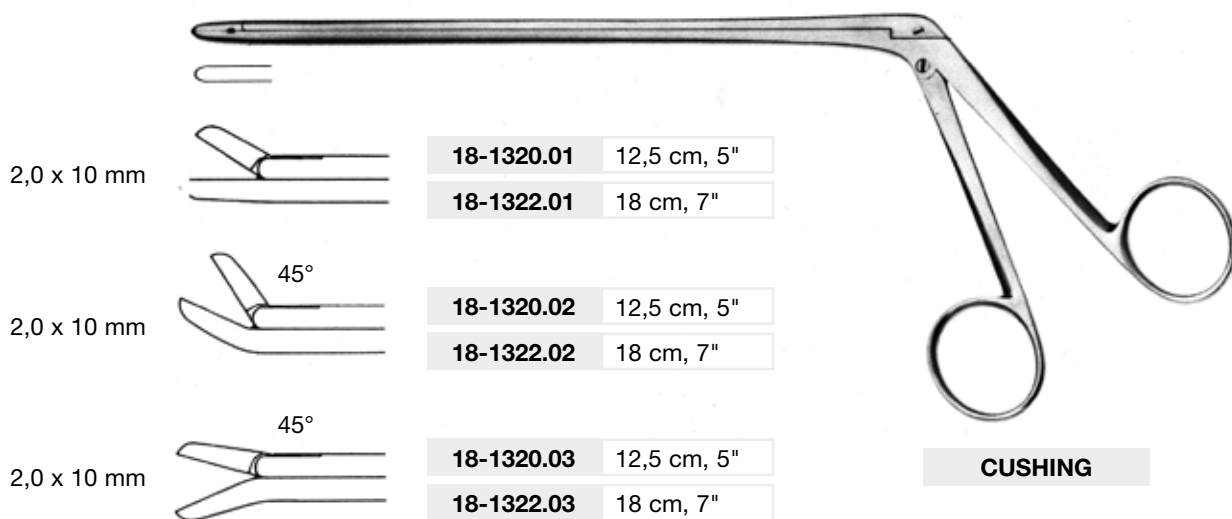

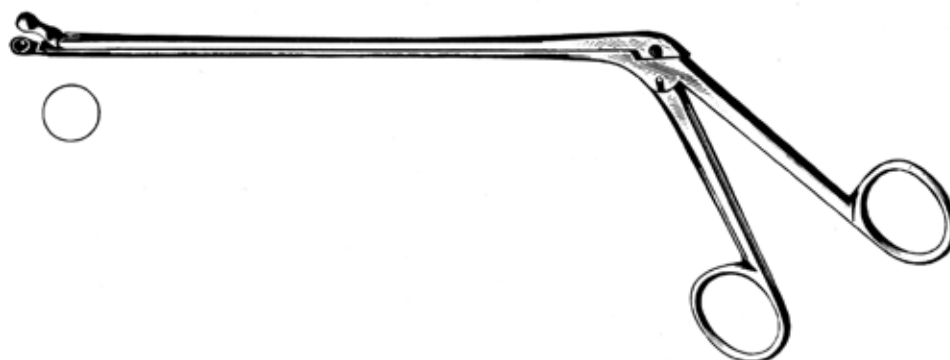

OLDBERG

18-1344.25

25 cm, 10"

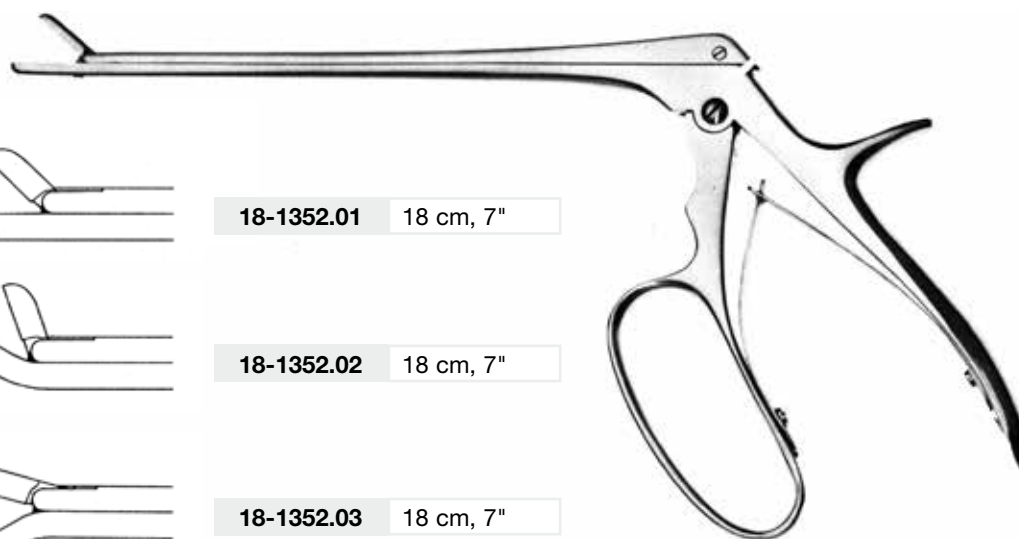

FERRIS-SMITH

3,0 x 10 mm



18-1352.01

18 cm, 7"

3,0 x 10 mm



18-1352.02

18 cm, 7"

3,0 x 10 mm

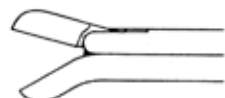

18-1352.03

18 cm, 7"

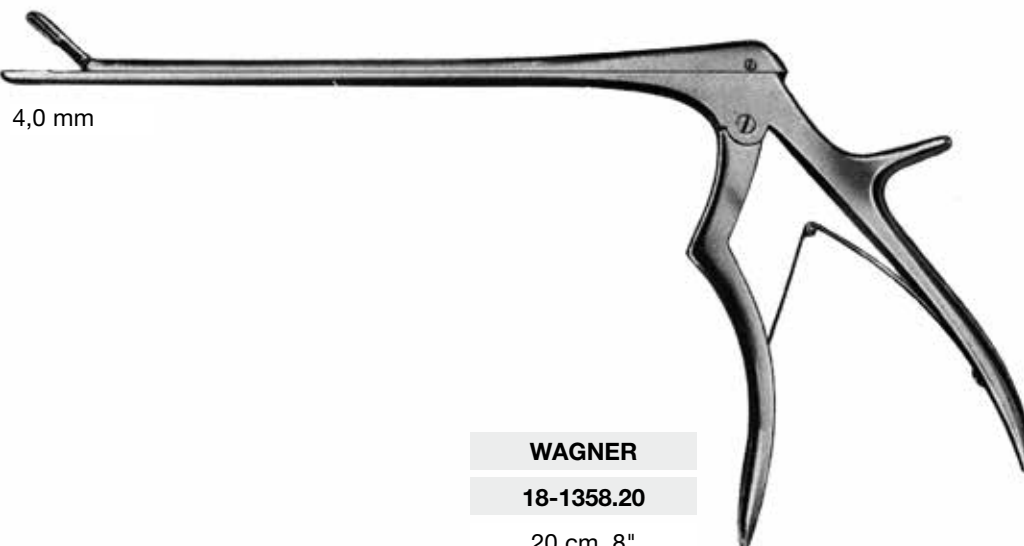

4,0 mm

WAGNER

18-1358.20

20 cm, 8"

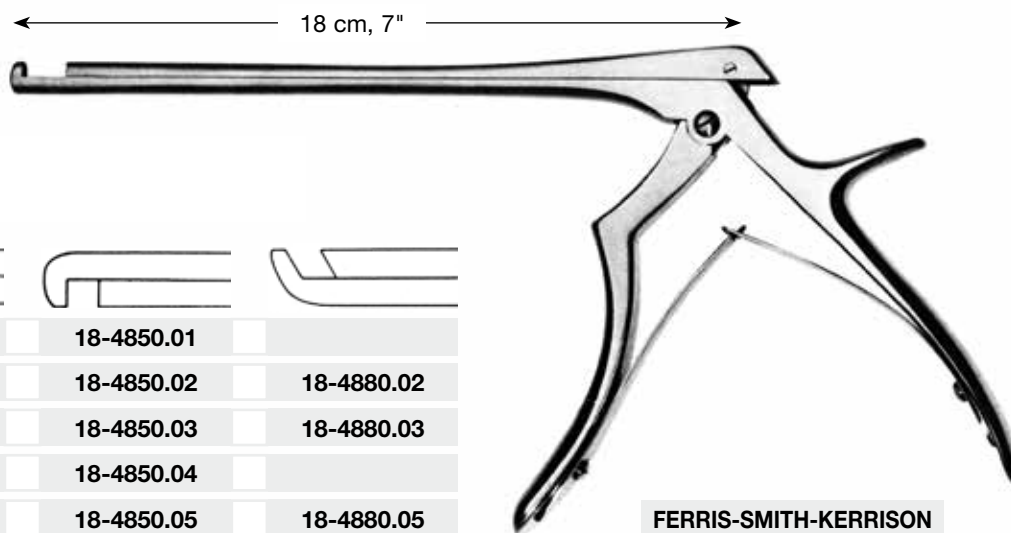

1 mm	18-4800.01	18-4850.01	
2 mm	18-4800.02	18-4850.02	18-4880.02
3 mm	18-4800.03	18-4850.03	18-4880.03
4 mm	18-4800.04	18-4850.04	
5 mm	18-4800.05	18-4850.05	18-4880.05

FERRIS-SMITH-KERRISON

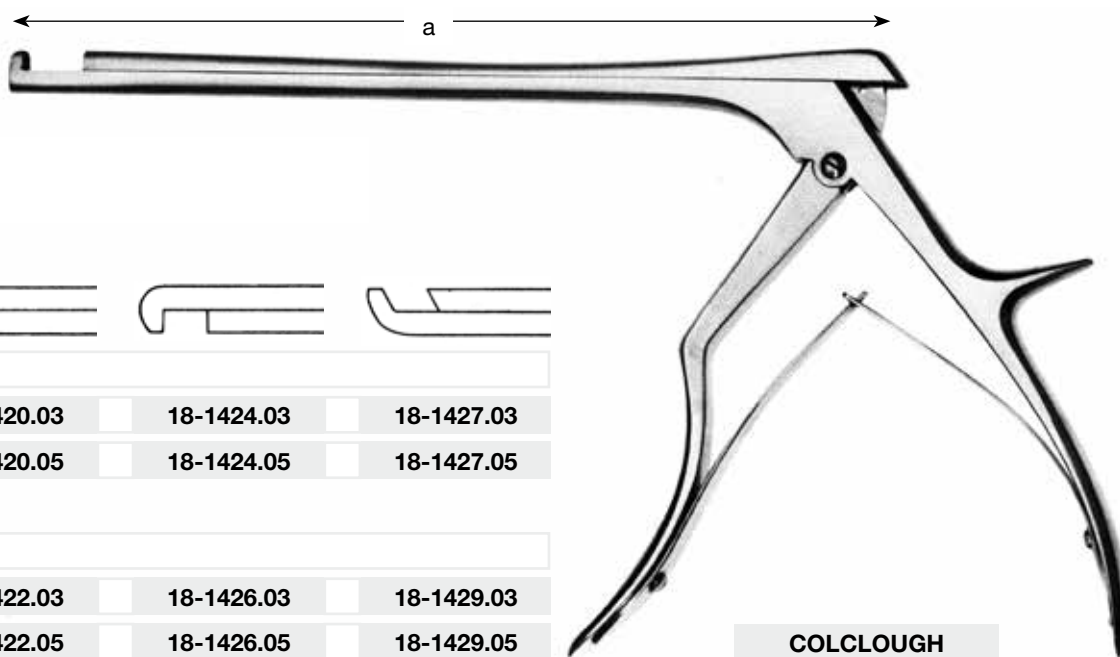

a = 15 cm, 5 3/4"

3 mm	18-1420.03	18-1424.03	18-1427.03
5 mm	18-1420.05	18-1424.05	18-1427.05

a = 20 cm, 8"

3 mm	18-1422.03	18-1426.03	18-1429.03
5 mm	18-1422.05	18-1426.05	18-1429.05

COLCLOUGH

Neuro- und Gefäßchirurgie
Neuro and Vascular Surgery
Neuchirurgie et chirurgie vasculaire
Neurocirugía y cirugía vascular



MINI
permanent



Kat. Nr. Cat. ref. No. de cat. Núm. de cat.	18-1470.30	18-1472.30	18-1480.35	18-1482.35	18-1484.33	18-1490.30	18-1492.35
Maullänge Length of Jaws Longueur des mors Longitud de boca	3,0 mm	3,0 mm	5,0 mm	5,0 mm	5,0 mm	3,0 mm	5,0 mm
Maulöffnung Opening of jaws Ouverture des mors Apertura de boca	3,0 mm	3,0 mm	3,5 mm	3,5 mm	3,3 mm	3,0 mm	3,5 mm
Schließkraft Closing Force Force de fermeture Presión de oclusión	100-130 g	100-130 g	100-130 g	100-130 g	100-130 g	100-130 g	100-130 g



18-1494.35	18-1496.33	18-1498.30	18-1510.40	18-1512.38	18-1514.35	18-1518.50	18-1566.40
5,0 mm	5,0 mm	5,0 mm	7,0 mm	7,0 mm	7,0 mm	7,0 mm	7,0 mm
3,5 mm	3,3 mm	3,0 mm	4,0 mm	3,8 mm	3,5 mm	5,0 mm	4,0 mm
100-130 g	100-130 g	100-130 g	100-130 g	100-130 g	100-130 g	80-100 g	100-130 g



MINI
temporary



Kat. Nr. Cat. ref. No. de cat. Núm. de cat.	18-1471.30	18-1481.35	18-1483.35	18-1511.40	18-1513.38	18-1515.35
Maullänge Length of Jaws Longueur des mors Longitud de boca	3,0 mm	5,0 mm	5,0 mm	7,0 mm	7,0 mm	7,0 mm
Maulöffnung Opening of jaws Ouverture des mors Apertura de boca	3,0 mm	3,5 mm	3,5 mm	4,0 mm	3,8 mm	3,5 mm
Schließkraft Closing Force Force de fermeture Presión de oclusión	35-45 g	35-45 g	35-45 g	40-50 g	40-50 g	40-50 g

Neuro- und Gefäßchirurgie
Neuro and Vascular Surgery
Neuchirurgie et chirurgie vasculaire
Neurocirugía y cirugía vascular



STANDARD
permanent



Kat. Nr. Cat. ref. No. de cat. Núm. de cat.	18-1420.55	18-1422.53	18-1424.48	18-1426.50	18-1426.68	18-1430.60	18-1432.60
Maullänge Length of Jaws Longueur des mors Longitud de boca	7,0 mm	7,0 mm	7,0 mm	7,0 mm	7,0 mm	9,0 mm	9,0 mm
Maulöffnung Opening of jaws Ouverture des mors Apertura de boca	5,5 mm	5,3 mm	4,8 mm	5,0 mm	6,8 mm	6,0 mm	6,0 mm
Schließkraft Closing Force Force de fermeture Presión de oclusión	110-140 g	110-140 g	110-140 g	110-140 g	110-140 g	110-140 g	110-140 g



Kat. Nr. Cat. ref. No. de cat. Núm. de cat.	18-1434.50	18-1438.75	18-1440.68	18-1442.65	18-1444.58	18-1450.80	18-1452.75
Maullänge Length of Jaws Longueur des mors Longitud de boca	9,0 mm	9,0 mm	11,0 mm	11,0 mm	11,0 mm	15,0 mm	15,0 mm
Maulöffnung Opening of jaws Ouverture des mors Apertura de boca	5,0 mm	7,5 mm	6,8 mm	6,5 mm	5,8 mm	8,0 mm	7,5 mm
Schließkraft Closing Force Force de fermeture Presión de oclusión	110-140 g	110-140 g	110-140 g	110-140 g	110-140 g	100-130 g	100-130 g

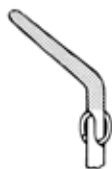

Kat. Nr. Cat. ref. No. de cat. Núm. de cat.	18-1454.65	18-1470.68	18-1480.38
Maullänge Length of Jaws Longueur des mors Longitud de boca	15,0 mm	9,0 mm	7,0 mm
Maulöffnung Opening of jaws Ouverture des mors Apertura de boca	6,5 mm	6,8 mm	3,8 mm
Schließkraft Closing Force Force de fermeture Presión de oclusión	100-130 g	110-140 g	110-140 g



STANDARD
temporary



Kat. Nr. Cat. ref. No. de cat. Núm. de cat.	18-1431.73	18-1433.73	18-1435.63	18-1451.00
Maullänge Length of Jaws Longueur des mors Longitud de boca	9,0 mm	9,0 mm	9,0 mm	15,0 mm
Maulöffnung Opening of jaws Ouverture des mors Apertura de boca	7,3	7,3 mm	6,3 mm	10,0 mm
Schließkraft Closing Force Force de fermeture Presión de oclusión	40-50 g	40-50 g	40-50 g	60-80 g

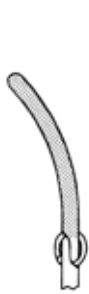

Kat. Nr. Cat. ref. No. de cat. Núm. de cat.	18-1453.93	18-1455.80	18-1461.12	18-1463.11
Maullänge Length of Jaws Longueur des mors Longitud de boca	15,0 mm	15,0 mm	20,0 mm	20,0 mm
Maulöffnung Opening of jaws Ouverture des mors Apertura de boca	9,3 mm	8,0 mm	12,0 mm	11,5 mm
Schließkraft Closing Force Force de fermeture Presión de oclusión	60-80 g	60-80 g	80-100 g	80-100 g



Anlegezangen
 Applying Forceps
 Pinces de poser
 Pinzas de aplicación

18-1572.21	MINI
18-1574.21	STANDARD

21 cm, 8 1/4"





BARRAQUER (COLIBRI)

19-0100.03 3 cm, 1 1/4"

19-0100.04 4 cm, 1 1/2"



BOWMANN

19-0101.07

7 cm, 2 3/4"

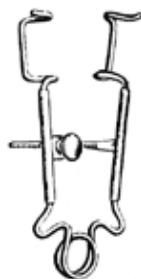

CRITCHETT

19-0102.07

7 cm, 2 3/4"



SMITH

19-0102.05

5 cm, 2"



CLARK

19-0103.08

8 cm, 3 1/4"



GRAEFE

19-0104.07 7 cm, 2 3/4"

19-0104.09 9 cm, 3 1/4"



WEEK

19-0105.08

8 cm, 3 1/4"

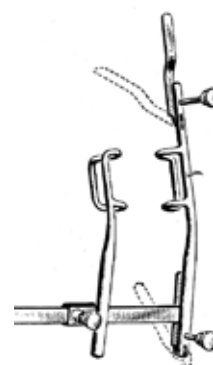

ARRUGA

19-0106.07

7 cm, 2 3/4"

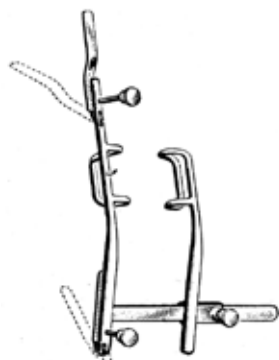

ARRUGA

19-0107.07

7 cm, 2 3/4"



MURDOCK

19-0108.05

5 cm, 2"



MELLINGER-AXENFELD

19-0110.07

7 cm, 2 3/4"



MELLINGER-AXENFELD

19-0111.07

7 cm, 2 3/4"

Lidsperrer
Eye Specula
Blépharostats
Blefaróstatos



MELLINGER

19-0112.05 5 cm, 2"

19-0112.07 7 cm, 2 3/4"



LISTER-BURCH

19-0113.08

8 cm, 3 1/2"



WILLIAMS

19-0115.08

8 cm, 3 1/2"



LANCASTER

19-0130.07

7 cm, 2 3/4"



ZIEGLER

19-0132.07

7 cm, 2 3/4"



CASTROVIEJO

19-0190.08

8 cm, 3 1/2"



PARK

19-0192.08

8 cm, 3 1/4"



MUELLER

19-0193.07

7 cm, 2 3/4"



GOLDSTEIN

19-0194.03

3 cm, 1 1/4"



STEVENSON

19-0195.07

7 cm, 2 3/4"



Lidplatte
 Lid Plate
 Plaque à paupières
 Placa para párpados

JAEGER

19-0301.11

11 cm, 4 1/2"



19-1120.00

Fig. 0



19-1120.01

Fig. 1



19-1120.02

Fig. 2



19-1120.03

Fig. 3



Starmesser
 Cataract Knives
 Couteaux à cataracte
 Cuchillos para catarata

Starmesser
 Cataract Knife
 Couteaux à cataracte
 Cuchillo para catarata

GRAEFE

DEUTSCHMANN

19-1142.13

13 cm, 5"



19-1180.01

Fig. 1



19-1180.02

Fig. 2



19-1180.03

Fig. 3



19-1181.01

Fig. 1



19-1181.02

Fig. 2



19-1181.03

Fig. 3



BERENS

19-1183.13

13 cm, 5"

4 x 13 mm



CASTROVIEJO

19-1185.13

13 cm, 5"

JAEGER

Augenmesser
Eye Knives
Couteaux oculaires
Cuchillos para ojos



GRAEFE

19-1187.13

13 cm, 5"



KNAPP



19-1202.01

Fig. 1



19-1202.02

Fig. 2



19-1202.03

Fig. 3



DEAN

19-1211.12

12,5 cm, 5"



ZIEGLER

5 mm



19-1210.01

Fig. 1

6 mm



19-1210.02

Fig. 2

7 mm



19-1210.03

Fig. 3

0,4 mm



19-1214.04

0,8 mm



19-1214.08



BOWMANN

13 cm, 5"



WHEELER

19-1218.12

12 cm, 4 3/4"



ZIEGLER

19-1221.11

11 cm, 4 1/2"



SATO

19-1226.12

12,5 cm, 5"



TOOK

19-1228.12

12 cm, 4 3/4"



GILL

19-1231.12

12 cm, 4 3/4"

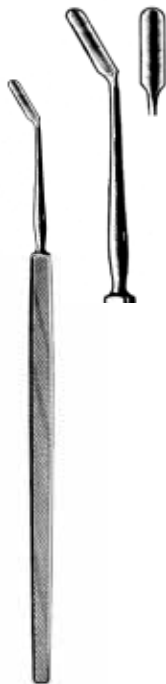

ELSCHMIG

19-1233.13

13 cm, 5"



PATON

19-1245.12

12 cm, 4 3/4"



LUNDSGAARD

19-1253.12

12 cm, 4 3/4"

Augenmesser
Eye Knives
Couteaux oculaires
Cuchillos para ojos



GUYTON-LUNDSGAARD

19-1253.12

12 cm, 4 3/4"



KUHNT

19-1240.01

Fig. 1

19-1240.02

Fig. 2

19-1240.03

Fig. 3

19-1240.04

Fig. 4



BARRKAN

19-1256.12

12 cm, 4 3/4"



SCHEIE

19-1258.12

12 cm, 4 3/4"



BURCH

19-1262.12

12 cm, 4 3/4"



PAUFIQUE

19-1271.11

11 cm, 4 1/2"



BARRAQUER

19-1273.13

13 cm, 5"



19-1304.12

12 cm, 4 3/4"



19-1305.12

12 cm, 4 3/4"



19-1310.13

13 cm, 5"



19-1311.13

13 cm, 5"



BOWMANN

19-1208.12

12 cm, 4 3/4"



19-1209.12

12 cm, 4 3/4"



LEVINSON

19-1314.13

13 cm, 5"



FRANCIS

19-1321.12

12 cm, 4 3/4"



DAVIS

19-1325.13

13 cm, 5"





LA FORCE

19-1327.12

12 cm, 4 3/4"



DIX

19-1330.13

13 cm, 5"



ELLIS

19-1331.11

11 cm, 4 1/2"



WALTON

19-1332.12

12 cm, 4 3/4"

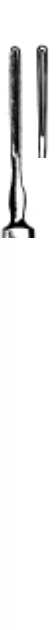

WALTON

19-1334.12

12 cm, 4 3/4"



ALVIS

19-1336.12

12 cm, 4 3/4"



GREEN

19-1340.13

13 cm, 5"



ROLLET

19-1342.12

12 cm, 4 3/4"



JAMESON

19-1353.13

13 cm, 5"



GREEN

19-1355.13

13 cm, 5"



19-1351.01

Fig. 1

GRAEFE



19-1351.02

Fig. 2



19-1351.03

Fig. 3



19-1363.01

Fig. 1

ARRUGA



19-1363.02

Fig. 2



STEVENS

19-1357.13

13 cm, 5"



O'CONNOR

19-1370.12

12 cm, 4 3/4"



WIENER

19-1372.13

13 cm, 5"



WIENER

19-1373.13

13 cm, 5"



ROLLET

19-1376.13

13 cm, 5"

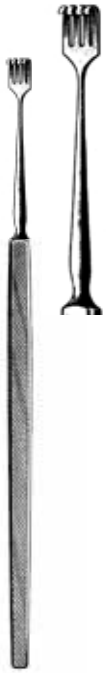

KNAPP

19-1377.13

13 cm, 5"



GRAEFE

19-1380.13

13 cm, 5"



19-1381.13

13 cm, 5"



19-1383.13

13 cm, 5"



BECKER

19-1386.13

13 cm, 5"

Chalazions- und Starlöffel

Scoops and Curettes for Chalazio and Cataract

Curettes et cuillers pour chalazion et cataracte

Curetas y cucharillas para chalazión y catarata



MEYHOEFER

19-1402.05

Ø 0,5 mm



19-1402.10

Ø 1,0 mm



19-1402.15

Ø 1,5 mm



19-1402.18

Ø 1,8 mm



19-1402.20

Ø 2,0 mm



19-1402.25

Ø 2,5 mm



19-1402.35

Ø 3,5 mm



19-1402.40

Ø 4,0 mm



19-1402.45

Ø 4,5 mm



Chalazions- und Starlöffel
Scoops and Curettes for Chalazio and Cataract
Curettes et cuillers pour chalazion et cataracte
Curetas y cucharillas para chalazión y catarata

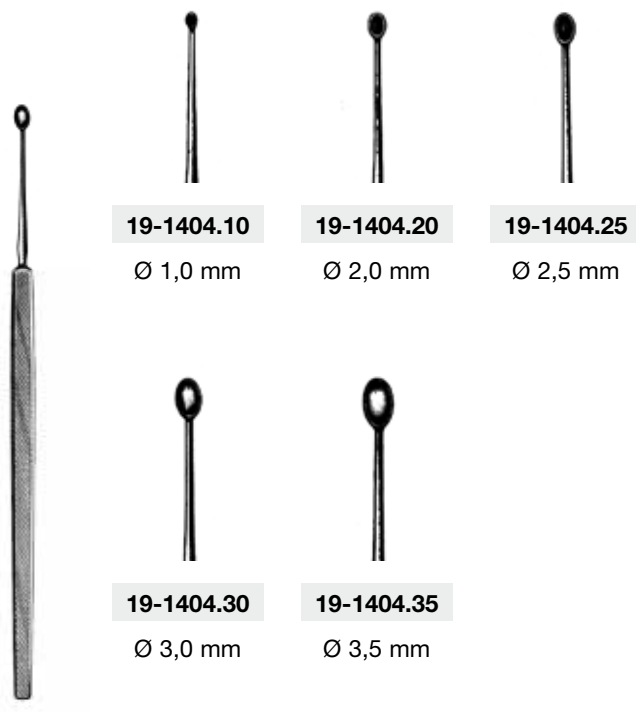

19-1404.10
 Ø 1,0 mm

19-1404.20
 Ø 2,0 mm

19-1404.25
 Ø 2,5 mm

19-1404.30
 Ø 3,0 mm

19-1404.35
 Ø 3,5 mm

HEBRA

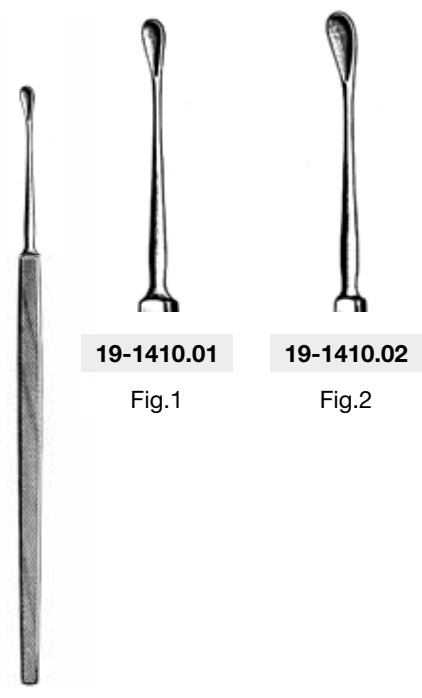

19-1410.01
 Fig.1

19-1410.02
 Fig.2

GRAEFE

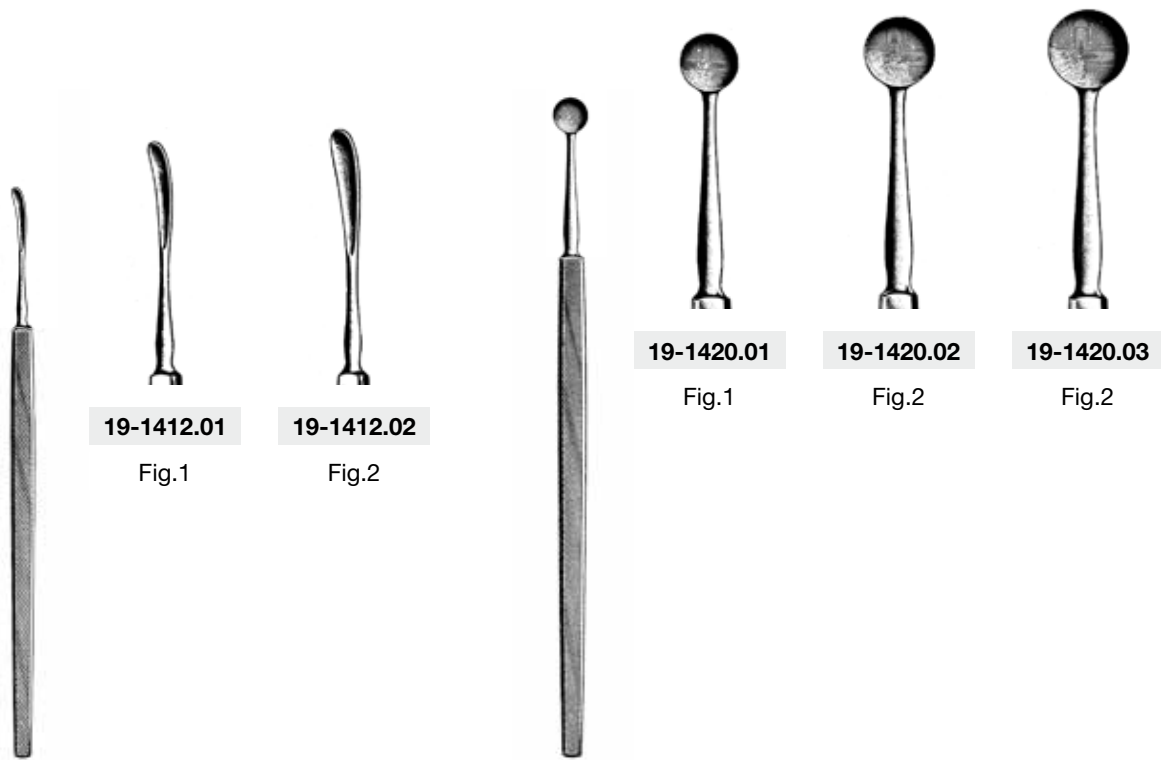

19-1412.01
 Fig.1

19-1412.02
 Fig.2

19-1420.01
 Fig.1

19-1420.02
 Fig.2

19-1420.03
 Fig.2

DAVIEL

BUNGE

19

Chalazions- und Starlöffel
Scoops and Curettes for Chalazio and Cataract
Curettes et cuillers pour chalazion et cataracte
Curetas y cucharillas para chalazión y catarata



AXENFELD

19-1407.13

13 cm, 5"

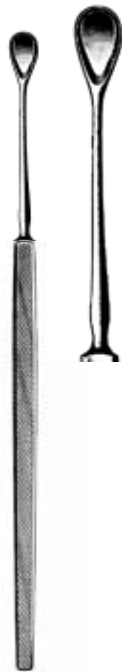

KNAPP

19-1414.02



LANG

19-1424.13

13 cm, 5"



WEBER

19-1441.01

Fig. 1



19-1441.02

Fig. 2

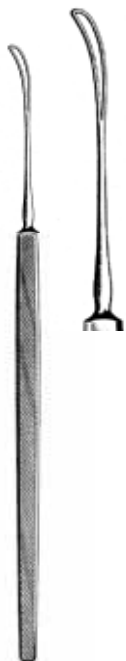

SNELLEN

19-1443.13

13 cm, 5"



19-1445.13

Fig.1



19-1447.13

Fig.2



ARLT



19-1449.01

Fig.1



19-1449.02

Fig.2



19-1461.13
 13 cm, 5"

19-1462.13
 13 cm, 5"

CULLER

19-1467.13
 13 cm, 5"

ARRUGA

19-1485.13
 13 cm, 5"

WADSWORTH-TODD

19-1487.14
 14 cm, 5 1/2"

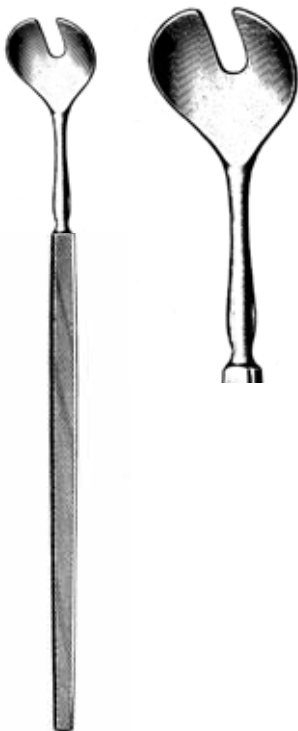

WELLS

19-1482.20
 20 cm, 8"

BANGERTER

19-1501.06
 6,0 mm

19-1501.10
 10,0 mm

19-1501.12
 12,0 mm

Zyklodialysespatel, Fremdkörperinstrumente
Cyclodialysis spatulae, Foreign Body Instruments
Spatules à cyclodialyse, Instruments à corps étrangers
Espátulas para ciclodiálisis, Instrumentos para cuerpos extraños

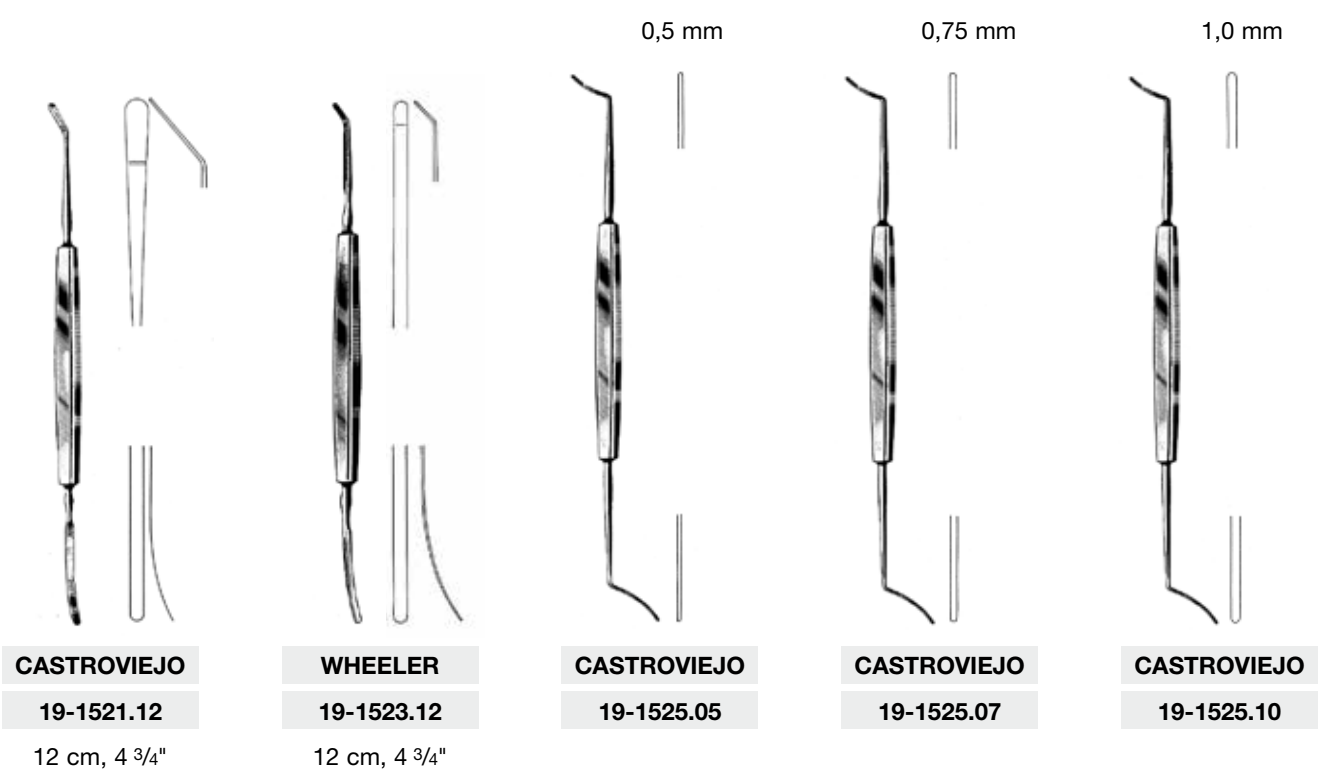
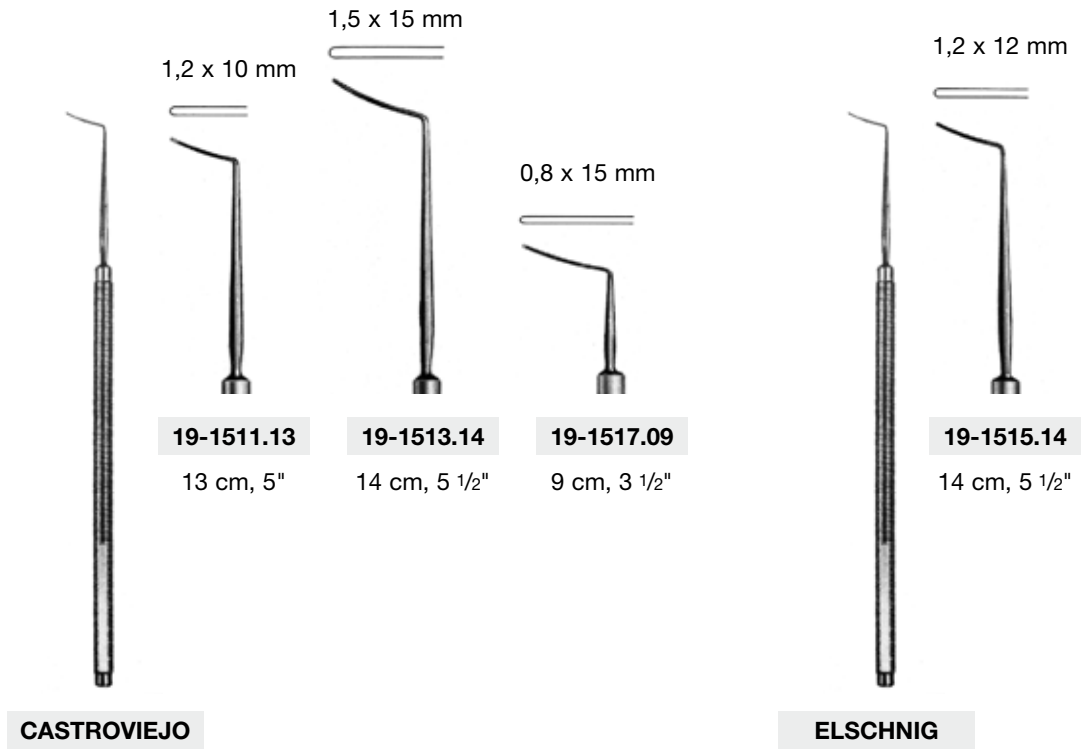

Zyklodialysespatel, Fremdkörperinstrumente
 Cyclodialysis spatulae, Foreign Body Instruments
 Spatules à cyclodialyse, Instruments à corps étrangers
 Espátulas para ciclodiálisis, Instrumentos para cuerpos extraños



DIX

19-1542.12

12 cm, 4 3/4"



DIX

19-1544.12

12 cm, 4 3/4"



DIX

19-1546.13

13 cm, 5"



DIX

19-1548.13

13 cm, 5"

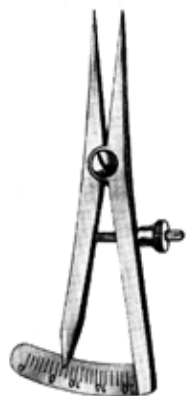

CASTROVIEJO

19-1583.07

0 - 20 mm



CONNIN-AMSLER

19-1589.13

13 cm, 5"



DASTOOR

19-1590.06

6 cm, 2 1/4"



HOLTH

19-1593.09

9 cm, 3 1/2"

Tränenang-Dilatatore, Tränenkanal-Sonden
 Lachrymal Dilators, Lachrymal Probes
 Dilatateurs pour canal lacrymal, Stylets pour le canal lacrymal
 Dilatadores para canal lacrimal, Estiletos para canal lacrimal



WILDER

19-1602.01

Fig. 1



WILDER

19-1602.02

Fig. 2



WILDER

19-1602.03

Fig. 3



ZIEGLER

19-1605.12 Fig. 1/2

19-1605.34 Fig. 3/4

19-1605.56 Fig. 5/6



CASTROVIEJO

19-1608.12

12 cm, 4 3/4"



BOWMANN

19-1614.00 Fig. 00/0

19-1614.01 Fig. 0/1

19-1614.12 Fig. 1/2

19-1614.23 Fig. 2/3

19-1614.34 Fig. 3/4

19-1614.45 Fig. 4/5

19-1614.56 Fig. 5/6

19-1614.67 Fig. 6/7

19-1614.78 Fig. 7/8



BOWMANN

19-1616.00 Fig. 00/0

19-1616.01 Fig. 0/1

19-1616.12 Fig. 1/2

19-1616.23 Fig. 2/3

19-1616.34 Fig. 3/4

19-1616.45 Fig. 4/5

19-1616.56 Fig. 5/6

19-1616.67 Fig. 6/7

19-1616.78 Fig. 7/8

Iris-Pinzetten
Iris Forceps
Pinces à iris
Pinzas para iris

1 mm



GRAEFE

19-7020.07

7 cm, 2 3/4"

1 mm



GRAEFE

19-7021.07

7 cm, 2 3/4"

1 mm



GRAEFE

19-7022.07

7 cm, 2 3/4"

1 mm



GRAEFE

19-7023.07

7 cm, 2 3/4"

1 x 2



GRAEFE

19-7010.01

10 cm, 4"

1 x 2



GRAEFE

19-7011.01

10 cm, 4"



GRAEFE

19-7011.02

10 cm, 4"

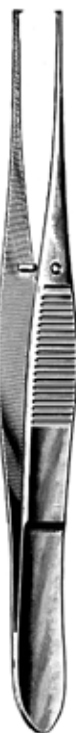

GRAEFE

19-7012.01

10 cm, 4"



GRAEFE

19-7013.01

10 cm, 4"

1 x 2



GRAEFE

19-7013.02

10 cm, 4"

Iris-Pinzetten
Iris Forceps
Pinces à iris
Pinzas para iris



1 x 2



1 x 2



1 x 2



STEVENS

19-7030.01

10,5 cm, 4"

STEVENS

19-7031.01

10,5 cm, 4"

STEVENS

19-7031.02

10,5 cm, 4"

STEVENS

19-7032.01

10,5 cm, 4"

STEVENS

19-7033.01

10,5 cm, 4"

STEVENS

19-7033.02

10,5 cm, 4"



1 x 2

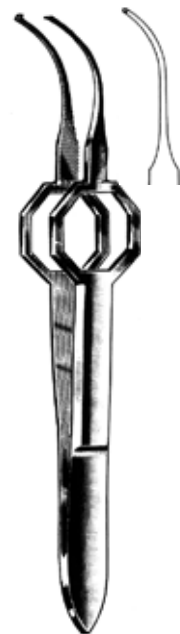

1 x 2

FOERSTER

19-7120.08

8,5 cm, 3 1/2"

FOERSTER

19-7121.08

8,5 cm, 3 1/2"

FOERSTER

19-7122.08

8,5 cm, 3 1/2"

FOERSTER

19-7123.08

8,5 cm, 3 1/2"

Iris-Pinzetten
Iris Forceps
Pinces à iris
Pinzas para iris

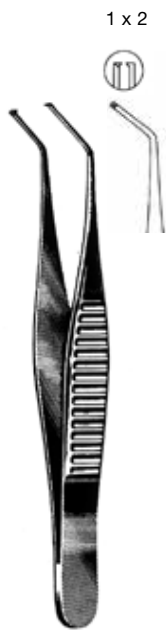

HESS

19-7061.07

7 cm, 2 3/4"

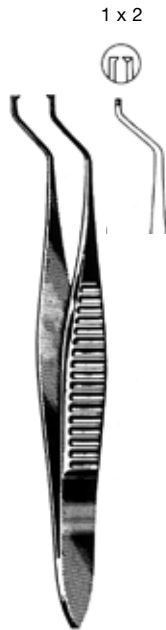

HESS

19-7063.07

7 cm, 2 3/4"



GILL

19-7091.07

7,5 cm, 3"



FISCHER

19-7081.07

7 cm, 2 3/4"



GILL-HESS

19-7093.07

7,5 cm, 3"



GILL-HESS

19-7095.07

7,5 cm, 3"



BARRAQUER-KATZIN

19-7231.07

7 cm, 2 3/4"



TROUTMAN (COLIBRI)

19-7233.07

7 cm, 2 3/4"

Iris-Pinzetten
Iris Forceps
Pinces à iris
Pinzas para iris



BARRAQUER (COLIBRI)

19-7235.07

7 cm, 2 3/4"



BARRAQUER (COLIBRI)

19-7237.07

7 cm, 2 3/4"



MC CULLOUGH

19-7840.09

9,5 cm, 3 3/4"



MC CULLOUGH

19-7842.09

9,5 cm, 3 3/4"

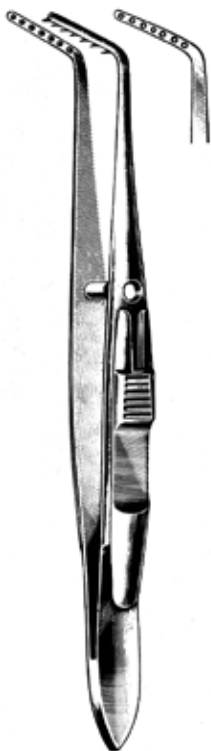

JAMESON

19-7810.01

10 cm, 4"

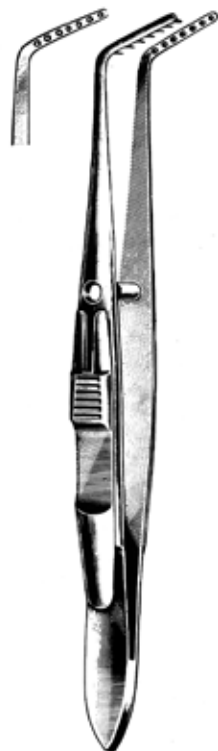

JAMESON

19-7810.02

10 cm, 4"



BONACCOLTO

19-7812.10

10 cm, 4"



BONACCOLTO

19-7814.10

10 cm, 4"

Iris-Pinzetten
Iris Forceps
Pinces à iris
Pinzas para iris



BONACCOLTO

19-7816.11

11 cm, 4 1/4"



KIRBY-ARTUR

19-7801.09

9 cm, 3 1/2"



DASTOOR

19-7818.11

11 cm, 4 1/4"



1 x 2

DASTOOR

19-7820.11

11 cm, 4 1/4"

0,5 mm



BISHOP-HARMAN

19-7102.08

8,5 cm, 3 1/2"

0,8 mm



BISHOP-HARMAN

19-7104.08

8,5 cm, 3 1/2"

0,5 mm



1 x 2

BISHOP-HARMAN

19-7106.08

8,5 cm, 3 1/2"

0,8 mm



1 x 2

BISHOP-HARMAN

19-7108.08

8,5 cm, 3 1/2"

Iris-Pinzetten
Iris Forceps
Pinces à iris
Pinzas para iris



MOD. BONN

19-7050.07

7 cm, 2 3/4"



MOD. BONN

19-7052.07

7 cm, 2 3/4"

0,12 mm



MOD. BONN

19-7054.10

10 cm, 4"

0,8 mm



TROUTMAN

19-7757.08

8,5 cm, 3 1/2"



MOD. TÜBINGEN

19-7570.10

10 cm, 4"



MOD. BONN

19-7576.10

10 cm, 4"

Iris-Pinzetten
Iris Forceps
Pinces à iris
Pinzas para iris



Spitzen
Hartmetall beschichtet

Tips Tungsten
Carbide coated

MOD. TÜBINGEN

19-7571.10

10 cm, 4"



PRINCE

19-7751.10

10 cm, 4"



PRINCE

19-7753.10

10 cm, 4"



BERKE

10 cm, 4"



19-7755.20

20 mm



19-7755.27

27 mm

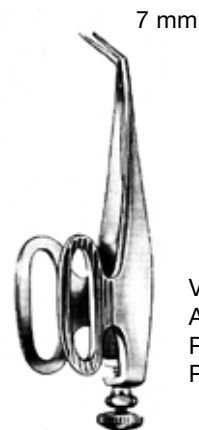

7 mm

Vorkammer-Pinzette
Anterior Chamber Forceps
Pince à chambre antérieure
Pinza para cámara anterior

BARRAQUER

19-7875.05

5,5 cm, 2 1/4"

Fixier-Pinzetten
Fixation Forceps
Pinces à fixation
Pinzas para fijación



ELSCHNIG

19-7710.11

11 cm, 4 1/2"



ohne Schloß
 without catch
 sans crémaillère
 sin cierre

GRAEFE

19-5020.11

11 cm, 4 1/2"



mit Schloß
 with catch
 à crémaillère
 con cierre

GRAEFE

19-5022.11

11 cm, 4 1/2"

1 x 2



LESTER

19-7720.09

9,5 cm, 3 3/4"



CASTROVIEJO

19-7702.09

9 cm, 3 1/2"



CASTROVIEJO

19-7703.09

9 cm, 3 1/2"



CASTROVIEJO

19-7704.09

9 cm, 3 1/2"



CASTROVIEJO

19-7705.09

9 cm, 3 1/2"

Fixier-Pinzetten, Kapsel-Pinzetten
Fixation Forceps, Capsular Forceps
Pinces à fixation, Pincas capsulaires
Pinzas para fijación, Pinzas capsulares



BARRAQUER

19-7730.09

10 cm, 4"



GREEN

10 cm, 4"



19-5010.05

5 mm



19-5010.10

10 mm

ohne Schloß
 without catch
 sans crémaillère
 sin cierre



19-5012.05

5 mm



19-5012.10

10 mm

mit Schloß
 with catch
 à crémaillère
 con cierre



GILL-ARRUGA

19-7427.07

7,5 cm, 3"



TERSON

19-7457.09

9 cm, 3 1/2"



KALT

19-7411.10

10 cm, 4"



ELSCHMIG

19-7412.10

10 cm, 4"

Kapsel-Pinzetten
Capsular Forceps
Pinces capsulaires
Pinzas capsulares

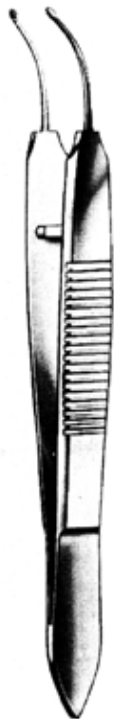

ARRUGA

19-7421.10

10 cm, 4"

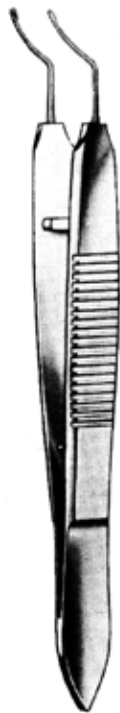

ARRUGA

19-7423.10

10 cm, 4"



CASTROVIEJO

19-7405.10

10 cm, 4"



SCHWEIGGER

19-7451.10

10 cm, 4"



SCHWEIGGER

19-7453.10

10 cm, 4"



ELSCHNIG

19-7455.10

10 cm, 4"



HESS

19-7475.06

6 cm, 2 1/2"



HESS

19-7477.06

6 cm, 2 1/2"



FUCHS

19-7463.07

7 cm, 2 3/4"

Naht- und Faden-Pinzetten
Suturing and Ligature Forceps
Pinces à sutures et à ligatures
Pinzas para suturas y para ligaduras



19-7210.01	0,12 mm
19-7210.03	0,30 mm
19-7210.05	0,50 mm
19-7210.10	1,00 mm
19-7210.15	1,50 mm

CASTROVIEJO

10 cm, 4"



19-7211.05	0,50 mm
19-7211.10	1,00 mm
19-7211.15	1,50 mm

CASTROVIEJO

10 cm, 4"



MOORFIELD

19-7244.10

10 cm, 4"



ST. MARTIN

19-7240.07

7 cm, 2 3/4"



MOD. TÜBINGEN

19-7242.10

10 cm, 4"

Naht- und Faden-Pinzetten
Suturing and Ligature Forceps
Pinces à sutures et à ligatures
Pinzas para suturas y para ligaduras



PAUFIQUE

19-7250.08

8,5 cm, 3 1/2"



PAUFIQUE

19-7252.08

8,5 cm, 3 1/2"

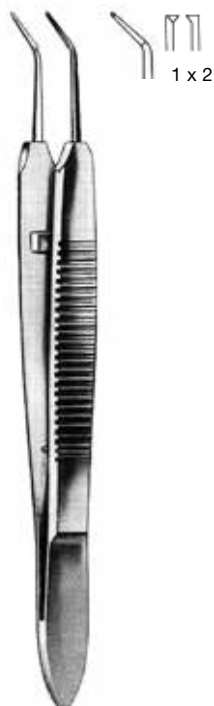

MC PHERSON

19-7255.10

10 cm, 4"



MC PHERSON

19-7257.10

10 cm, 4"

Pinzetten für Chalazion, Entropium und Trachom
Forceps for Chalazio, Entropium and Trachoma
Pinces à chalazion, à entropion, à granulations du trachome
Pinzas de chalazión, de entropión y para tracoma



AYER

19-7620.09

9 cm, 3 1/2"



AYER

19-7622.09

9 cm, 3 1/2"



LAMBERT

19-7636.09

9 cm, 3 1/2"

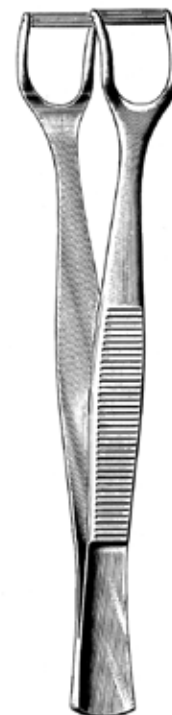

KNAPP-LUER

19-7362.11

11 cm, 4 1/4"



19-7609.01

Fig. 1



19-7609.02

Fig. 2



19-7609.03

Fig. 3

DESMARRES

9 cm, 3 1/2"



SNELLEN

19-7360.01

10 cm, 4"



SNELLEN

19-7360.02

10 cm, 4"

Augenkanülen
Eye Cannula
Canules oculaires
Cánulas oculares



SCHEIE

19-3515.28

1,0 x 28 mm



SCHEIE

19-3516.28

1,5 x 33 mm



MOD. TÜBINGEN

19-3517.45



MOD. HAMBURG

19-3518.00



SIMCOE

19-3519.00



MOD. BONN

19-3520.00



MOD. BONN

19-3521.00

Hornhaut-Trephinen
Corneal Trephines
Trépan cornéens
Trépanos corneales

19



CASTROVIEJO

19-2850.50	5,0 mm
19-2850.55	5,5 mm
19-2850.60	6,0 mm
19-2850.65	6,5 mm
19-2850.70	7,0 mm
19-2850.80	8,0 mm
19-2850.90	9,0 mm
19-2851.00	10,0 mm
19-2851.01	11,0 mm



ELLIOT

19-2810.00



Tonometer
 Tonometer
 Tonomètre
 Tonómetro

SCHIOETZ

19-3910.00

gerade Scala
 straight scale
 échelle droite
 escala recta

SCHIOETZ

19-3912.00

schräge Scala
 scale oblique
 échelle oblique
 escala oblicua

Cilien-Pinzetten
Cilia Forceps
Pinces à épiler les cils
Pinzas depilatorias

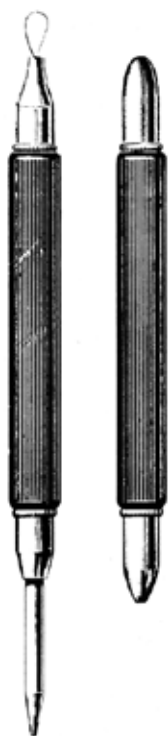

Fremdkörperschlinge
und Magnet

Foreign Body Remover
and Magnetic Eye Probe

Anse et aimant pour
corps étrangers

Asa e imán para cuerpos
extraños

19-1750.17

17 cm, 6 3/4"



BEER

19-7924.09

9 cm, 3 1/2"



DOUGLAS

19-7910.09

9 cm, 3 1/2"



LITTAUER

19-7916.08

8,5 cm, 3 1/2"



BARRAQUER

19-7951.10

10,5 cm, 4 1/4"



19-7936.09

9 cm, 3 1/2"



GRADLE

19-7940.09

9,5 cm, 3 3/4"



Ohr-Spekula
 Ear Specula
 Spéculums auriculaires
 Espéculos auriculares



HARTMANN

20-2010.30	3,0 mm
20-2010.45	4,5 mm
20-2010.55	5,5 mm
20-2010.65	6,5 mm
20-2010.75	7,5 mm

HARTMANN-SET

20-2010.00
4,5 mm - 7,5 mm

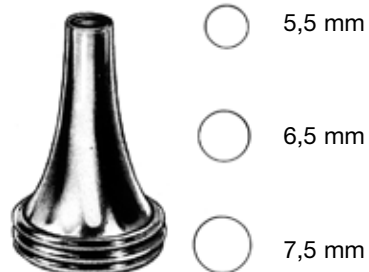

TOYNBEE

20-2012.55	5,5 mm
20-2012.65	6,5 mm
20-2012.75	7,5 mm

TOYNBEE-SET

20-2012.00
5,5 mm - 7,5 mm

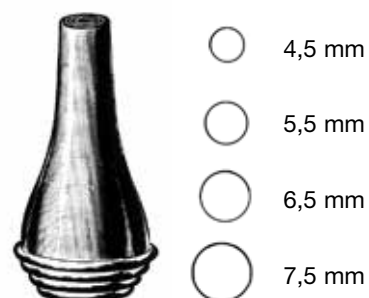

GRUBER

20-2014.45	4,5 mm
20-2014.55	5,5 mm
20-2014.65	6,5 mm
20-2014.75	7,5 mm

GRUBER-SET

20-2014.00
4,5 mm - 7,5 mm

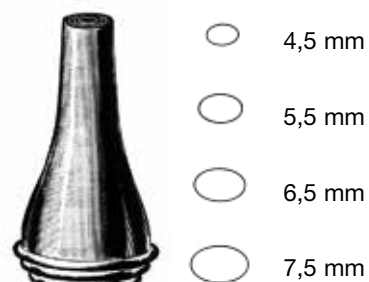

GRUBER

20-2015.45	4,5 mm
20-2015.55	5,5 mm
20-2015.65	6,5 mm
20-2015.75	7,5 mm

GRUBER-SET

20-2015.00
4,5 mm - 7,5 mm

Ohr-Spekula
 Ear Specula
 Spéculums auriculaires
 Espéculos auriculares

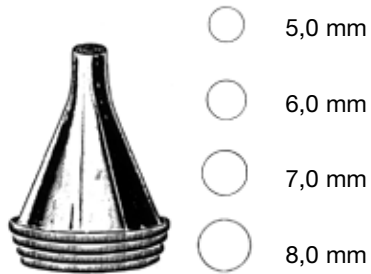

BOUCHERON	
20-2018.50	5,0 mm
20-2018.60	6,0 mm
20-2018.70	7,0 mm
20-2018.80	8,0 mm

BOUCHERON-SET
20-2018.00
5,0 mm - 8,0 mm

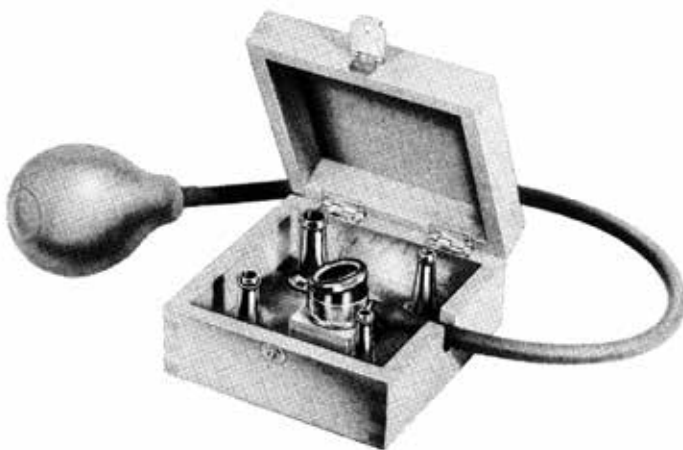

BRUENINGS-SET
 20-2030.04



SIEGLE-SET
 20-2036.03



HARTMANN

20-3570.01

C 128



HARTMANN

20-3570.02

C¹ 256



HARTMANN

20-3570.03

C² 512



HARTMANN

20-3570.04

C³ 1024



HARTMANN

20-3570.05

C⁴ 2048



HARTMANN

20-3571.00

Stimmgabeln
 Tuning Forks
 Diapasons
 Diapasones



LUCAE
 20-3874.01
 C 128



20-4075.00
 neurol.

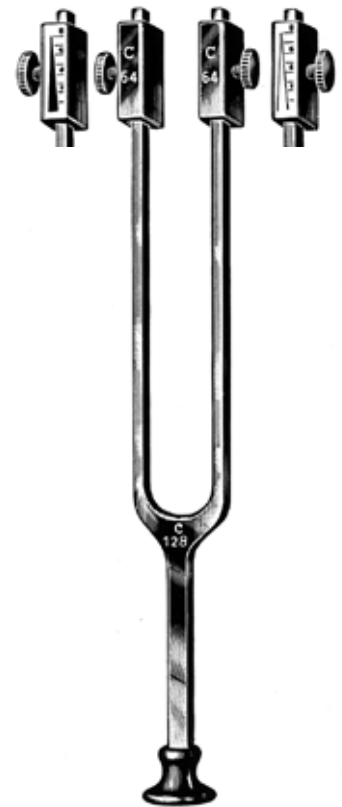

RYDEL-SEIFFER
 20-4076.01
 C 64 / C 128

Lärmtrommel
 Noise Apparatus
 Assourdisseur
 Ensordecedor



BARANY
 20-4080.00

Pulverbläser
 Powder Blowers
 Lance-Poudre
 Lanzapolvo



KABIERSKE
 20-4091.00
 30 cc

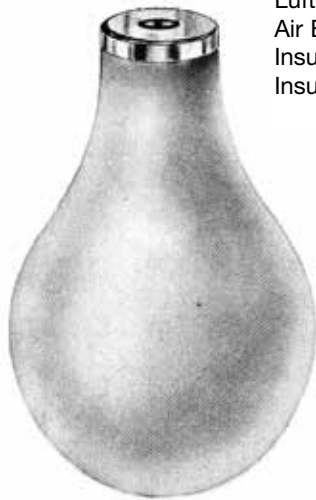

Luftdusche
Air Bag
Insufflateur d'air
Insuflador de aire



20-4191.03

POLITZER

20-4191.00

incl. 20-4191.03
20-4191.15
20-4191.17
20-4191.22

POLITZER

20-4191.01

incl. 20-4191.03
20-4191.04
20-4191.15
20-4191.17
20-4191.22



20-4191.04

Ø 4 mm



20-4191.15

Ø 15 mm



20-4191.17

Ø 17 mm



20-4191.22

Ø 22 mm

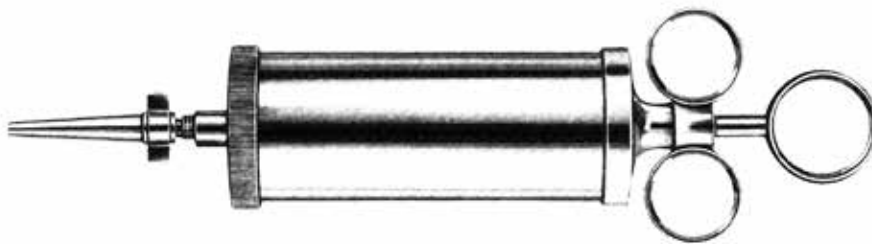

REINER

20-4596.50 50 ml

20-4596.75 75 ml

20-4597.10 100 ml

20-4597.15 150 ml



0 1 2 3 4 5

HARTMANN

20-4631.00 Fig. 0

20-4631.01 Fig. 1

20-4631.02 Fig. 2

20-4631.03 Fig. 3

20-4631.04 Fig. 4

20-4631.05 Fig. 5

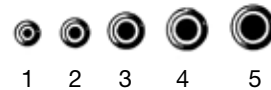

1 2 3 4 5

ITARD

20-4633.01 Fig. 1

20-4633.02 Fig. 2

20-4633.03 Fig. 3

20-4633.04 Fig. 4

20-4633.05 Fig. 5



stumpf
 blunt
 mousses
 romas

scharf
 sharp
 tranchantes
 cortantes

stumpf
 blunt
 mousses
 romas

scharf
 sharp
 tranchantes
 cortantes



Fig. 00	20-4609.00	20-4611.00	20-4614.00	20-4616.00
Fig. 0	20-4610.00	20-4612.00	20-4615.00	20-4617.00
Fig. 1	20-4610.01	20-4612.01	20-4615.01	20-4617.01
Fig. 2	20-4610.02	20-4612.02	20-4615.02	20-4617.02
Fig. 3	20-4610.03	20-4612.03	20-4615.03	20-4617.03
Fig. 4	20-4610.04	20-4612.04	20-4615.04	20-4617.04
Fig. 5	20-4610.05	20-4612.05	20-4615.05	20-4617.05

BUCK

16,5 cm, 6 1/2"



POLITZER

20-4650.18

18 cm, 7"



POLITZER

20-4651.16

16 cm, 6 1/4"



POLITZER

20-4653.16

16 cm, 6 1/4"



POLITZER

20-4660.15

15 cm, 5 3/4"



SEXTON

20-4662.18

18 cm, 7"



SEXTON

20-4664.17

17 cm, 6 3/4"



SEXTON

20-4665.17

17 cm, 6 3/4"



GROSS

20-4670.12

12 cm, 4 3/4"



GROSS

20-4671.12

12 cm, 4 3/4"



BILLEAU

16,5 cm, 6 1/2"



20-4680.01

Fig. 1



20-4680.02

Fig. 2



20-4680.03

Fig. 3



DAY
20-4690.01
 16 cm, 6 1/4"



DAY
20-4690.02
 16 cm, 6 1/4"



WAGENER
 14 cm, 5 1/2"

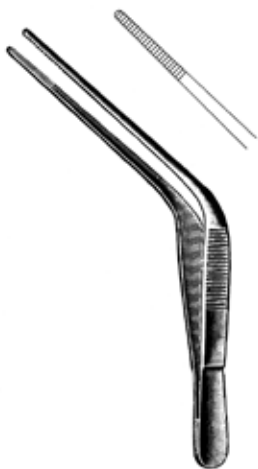

WILDE (TROELTSCH)
20-4701.12
 12 cm, 4 3/4"

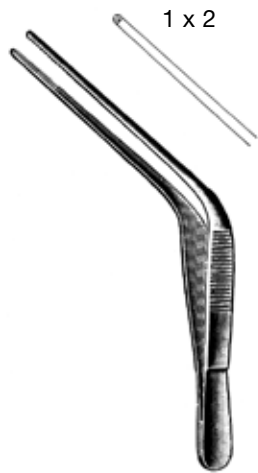

WILDE (TROELTSCH)
20-4703.12
 12 cm, 4 3/4"



LUCAE
20-4706.14
 14 cm, 5 1/2"



LUCAE
20-4706.16
 16 cm, 6 1/4"

Schnürer, Ohrzängchen
Snares, Ear Forceps
Serrenoed, Pincès auriculaires
Cierranudos, Pinzas auriculares

20



KRAUSE

20-4720.16

16 cm, 6 1/4"

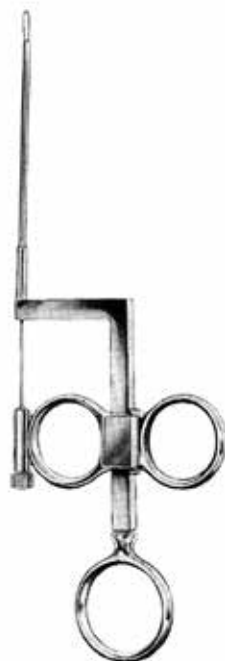

WILDE

20-4722.17

17 cm, 6 3/4"



20-4725.02

Dtzd. /doz. / douz / doc.



HARTMANN

20-4841.12

12 cm, 4 3/4"



HARTMANN

20-4841.14

14 cm, 5 1/2"



TILLEY

20-4843.14

14 cm, 5 1/2"



LITTAUER

20-4845.12

12 cm, 4 3/4"

Ohrzängchen
Ear Forceps
Pinces auriculaires
Pinzas auriculares



QUIRE
20-4851.10
 10 cm, 4"



BUCK
20-4853.11
 11 cm, 4 1/2"

Fremdkörperheber
 Foreign Body Levers
 Leviers pour corps étrangers
 Elevadores para cuerpos extraños



20-4861.08 8,5 cm, 3 1/4"
20-4861.14 14 cm, 5 1/2"
20-4861.16 16 cm, 6 1/4"



20-4865.08
 8,5 cm, 3 1/4"



20-4873.08
 8,5 cm, 3 1/4"



20-4863.08 8,5 cm, 3 1/4"
20-4863.14 14 cm, 5 1/2"

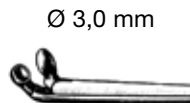

Ø 3,0 mm
20-4869.30
 8,5 cm, 3 1/4"



20-4867.20 8,5 cm, 3 1/4" 2,0 mm
20-4867.25 14 cm, 5 1/2" 2,5 mm
20-4867.30 16 cm, 6 1/4" 3,0 mm



HARTMANN

Ohrzangchen und -Scheren
Ear Forceps and Scissors
Pinces et ciseaux auriculaires
Pinzas y tijeras auriculares



HARTMANN-WULLSTEIN

20-4857.08



HARTMANN-WULLSTEIN

20-4855.08



STRUEMPEL

20-4871.08



HARTMANN-HOFFMANN

20-4875.08



8,5 cm, 3 1/4"



20-5010.40

4,0 mm



20-5012.55

5,5 mm



20-5013.55

5,5 mm



20-5015.55

5,5 mm



20-5017.55

5,5 mm

80 mm
 Mikro Ohrscheren
 Micro Ear Scissors
 Ciseaux auriculaires micro
 Tijeras auriculares micro

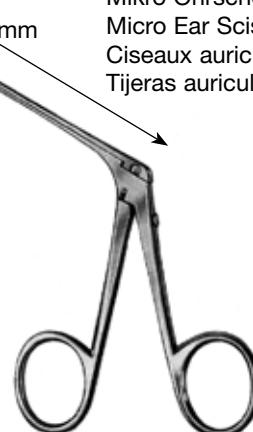

BELLUCCI



20-5020.70

7,0 mm



20-5021.70

7,0 mm



20-5022.70

7,0 mm

80 mm
 Mikro Ohrscheren
 Micro Ear Scissors
 Ciseaux auriculaires micro
 Tijeras auriculares micro

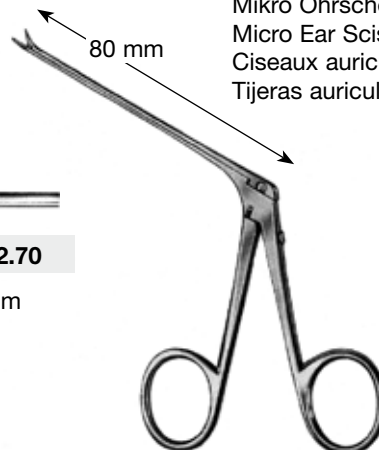

SHEA

20

Ohrzängchen
Ear Forceps
Pinces auriculaires
Pinzas auriculares



20-5050.40

4,0 mm



20-5070.70

7,0 mm



20-5052.40

4,0 mm



20-5053.60

6,0 mm



20-5055.60

6,0 mm



20-5057.40

4,0 mm



20-5059.40

4,0 mm



20-5060.35

3,5 mm



20-5062.45

4,5 mm



20-5063.45

4,5 mm



20-5065.45

4,5 mm



20-5067.50

5,0 mm



20-5069.50

5,0 mm



GREVEN

20-5070.50

5,0 mm



MC GEE

20-5071.40

0,8 x 4,0 mm



COS

20-5073.30

1,8 x 0,8 x 3,0 mm



JUERS

20-5075.60

6,0 mm



JUERS

20-5077.60

6,0 mm



HAUGH

20-5081.30

45°, 3,0 mm



HAUGH

20-5083.30

45°, 3,0 mm







Drahtbiegezängchen
 Wire closure forceps
 Pinces à plier le fil métallique
 Pinzas para doblar alambre

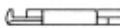

Ohrzängchen und -Scheren
 Ear Forceps and Scissors
 Pincettes et ciseaux auriculaires
 Pinzas y tijeras auriculares

Hammerkopf-Zwickzängchen
 Malleus Nippers
 Pincettes pour la tête du marteau
 Pinzas para la cabeza del martillo

- | | | | |
|---|-------------------|-------|---------------------|
|  | 20-5085.01 | micro | aufwärts
upward |
|  | 20-5087.01 | mini | en haut
arriba |
|  | 20-5085.02 | micro | abwärts
downward |
|  | 20-5087.02 | mini | en bas
abajo |



DIETER



20-5110.00



20-5112.00



20-5113.00



20-5115.00



20-5117.00



20-5119.00

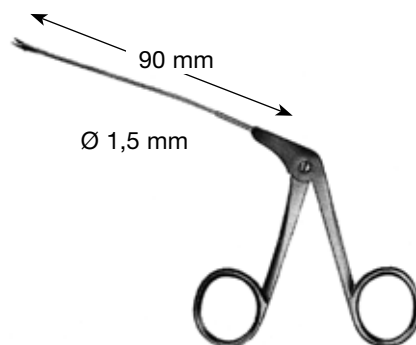

Ohrscheren
 Ear Scissors
 Ciseaux auriculaires
 Tijeras auriculares



20-5120.00



20-5122.00



20-5123.00



20-5125.00



20-5127.00



20-5129.00

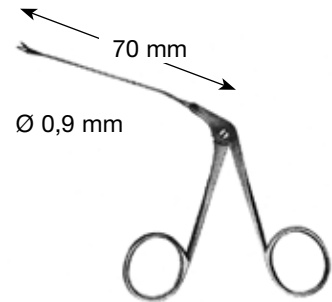

20-5130.00



20-5132.00



20-5133.00



20-5135.00



20-5137.00



20-5139.00



20-5139.08

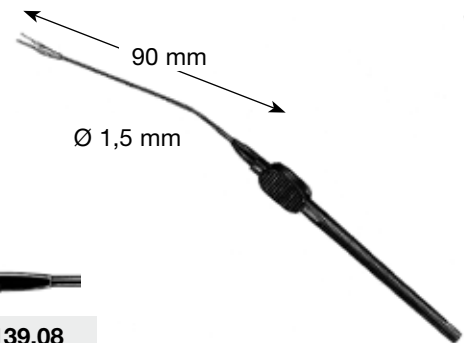

20-5140.00



20-5142.00



20-5143.00



20-5145.00



20-5147.00



20-5149.00

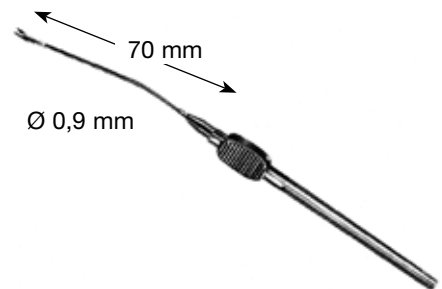

Ohrzängchen
 Ear Forceps
 Pincès auriculaires
 Pinzas auriculares



20-5210.00



20-5211.00



20-5213.00



20-5214.00



20-5215.00



20-5216.00



20-5217.00



20-5219.00

1 x 2



20-5220.00



20-5221.00



20-5310.00



20-5311.00



20-5313.00



20-5314.00



20-5315.00



20-5316.00



20-5317.00



20-5319.00

1 x 2



20-5320.00



20-5222.00 Ø 1,0 mm



20-5223.00 Ø 1,0 mm

20-5228.00 Ø 1,5 mm

20-5229.00 Ø 1,5 mm

20-5234.00 Ø 2,0 mm

20-5235.00 Ø 2,0 mm

20-5240.00 Ø 2,5 mm

20-5241.00 Ø 2,5 mm



20-5225.00 Ø 1,0 mm



20-5227.00 Ø 1,0 mm

20-5231.00 Ø 1,5 mm

20-5233.00 Ø 1,5 mm

20-5237.00 Ø 2,0 mm

20-5239.00 Ø 2,0 mm

20-5243.00 Ø 2,5 mm

20-5245.00 Ø 2,5 mm



Ohrzängchen
Ear Forceps
Pinces auriculaires
Pinzas auriculares



20-5322.00 Ø 1,0 mm

20-5328.00 Ø 1,5 mm

20-5334.00 Ø 2,0 mm

20-5340.00 Ø 2,5 mm



20-5323.00 Ø 1,0 mm

20-5329.00 Ø 1,5 mm

20-5335.00 Ø 2,0 mm

20-5341.00 Ø 2,5 mm



20-5325.00 Ø 1,0 mm

20-5331.00 Ø 1,5 mm

20-5337.00 Ø 2,0 mm

20-5343.00 Ø 2,5 mm



20-5327.00 Ø 1,0 mm

20-5333.00 Ø 1,5 mm

20-5339.00 Ø 2,0 mm

20-5345.00 Ø 2,5 mm



20-5246.00



20-5247.00



20-5248.00



20-5249.00



20-5346.00



20-5347.00



20-5348.00



20-5349.00



Ohrzängchen
 Ear Forceps
 Pinces auriculaires
 Pinzas auriculares



20-5550.00



20-5551.00



20-5553.00



20-5554.00



20-5555.00



20-5556.00



20-5557.00



20-5559.00

1 x 2



20-5560.00

1 x 2



20-5561.00



20-5562.00



20-5563.00



20-5565.00



20-5567.00



20-5586.00



20-5587.00



20-5588.00



20-5589.00



20-5650.00



20-5651.00



20-5653.00



20-5654.00



20-5655.00



20-5657.00



20-5659.00

1 x 2



20-5660.00



20-5662.00



20-5663.00



20-5665.00



20-5667.00



20-5686.00



20-5687.00



20-5688.00



20-5689.00



20



SCHUKNECHT
 20-6001.01



SCHUKNECHT
 20-6001.02



SCHUKNECHT
 20-6003.15
 15,5 cm, 6"



WULLSTEIN
 20-6004.15
 15,5 cm, 6"



TABB
 20-6005.15
 15,5 cm, 6"

Ø 3,5 mm



PLESTER
 20-6006.35
 15,5 cm, 6"



ROSEN



20-6009.10
 1,0 mm



20-6009.14
 1,4 mm



20-6009.16
 1,6 mm



20-6009.20
 2,0 mm



20-6009.26
 2,6 mm



20-6009.28
 2,8 mm



20-6009.30
 3,0 mm



20-6110.15



20-6111.15



20-6113.15



20-6115.15



BARBARA

25°

45°

90°



0,3 mm	20-6120.03	20-6122.03	20-6124.03
0,6 mm	20-6120.06	20-6122.06	20-6124.06
1,0 mm	20-6120.10	20-6122.10	20-6124.10
1,2 mm		20-6122.12	20-6124.12
1,5 mm		20-6122.15	20-6124.15
2,0 mm		20-6122.20	20-6124.20
2,5 mm		20-6122.25	20-6124.25

BARBARA



BARBARA

20-6125.05	0,5 mm
20-6125.10	1,0 mm

0,5 mm



BARBARA

20-6136.15	15,5 cm, 6"
------------	-------------



ROSEN

20-6137.15	15,5 cm, 6"
------------	-------------



MC GEE

0,5 mm	20-6133.05
1,0 mm	20-6133.10



0,5 mm	20-6135.05
1,0 mm	20-6135.10



	90°	90°	25°	25°	45°	45°
0,3 mm	20-6130.03	20-6132.03	20-6141.03	20-6143.03	20-6145.03	20-6147.03
0,6 mm	20-6130.06	20-6132.06	20-6141.06	20-6143.06	20-6145.06	20-6147.06
1,0 mm	20-6130.10	20-6132.10	20-6141.10	20-6143.10	20-6145.10	20-6147.10

ROSEN

20-6151.16 20-6153.16

20-6155.16 20-6157.16

FISCH

20-6200.01 1,0/1,2 mm

20-6200.02 1,5/1,8 mm

HOUSE

20-6202.01 1,0/1,2 mm

20-6202.02 1,5/1,8 mm

HOUSE



HOUSE

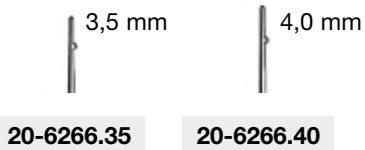

20-6266.35

20-6266.40

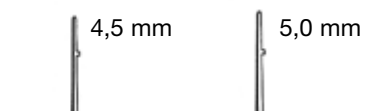

20-6266.45

20-6266.50



LEMPERT

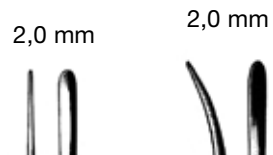

20-6302.16

20-6303.16



20-6305.16



LEMPERT

20-6307.20

20,5 cm, 8"



PASSOW



20-6310.02

2 x 2 mm



20-6310.03

3 x 3 mm



MUCK

20-6312.13

13 cm, 5"



Nasenspekula
Nasal Specula
Spéculum nasaux
Espéculos nasales



21-6450.01

Fig. 1

21-6450.02

Fig. 2

21-6450.03

Fig. 3

21-6450.04

Fig. 4



21-6460.01

Fig. 1

21-6460.02

Fig. 2



THUDICHUM



21-6450.05

Fig. 5

21-6450.06

Fig. 6

21-6450.07

Fig. 7



VOLTOLINI



21-6460.03

Fig. 3

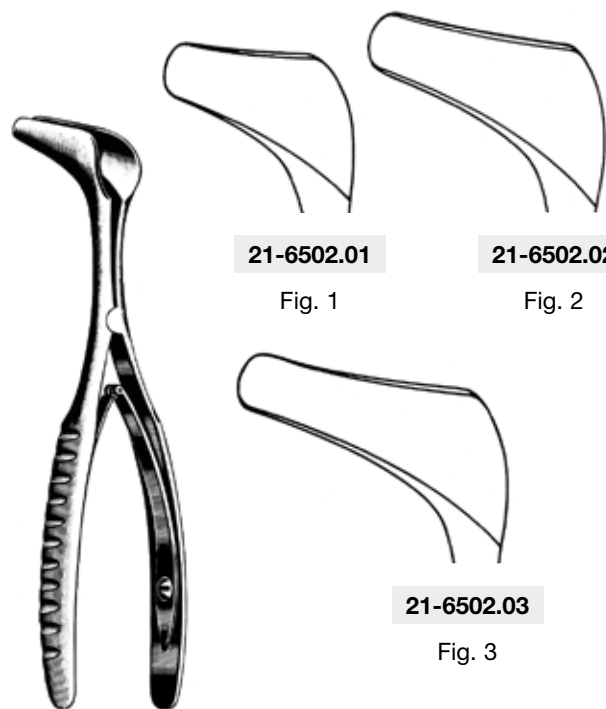

21-6502.01

Fig. 1

21-6502.02

Fig. 2

21-6502.03

Fig. 3

HARTMANN-HALLE

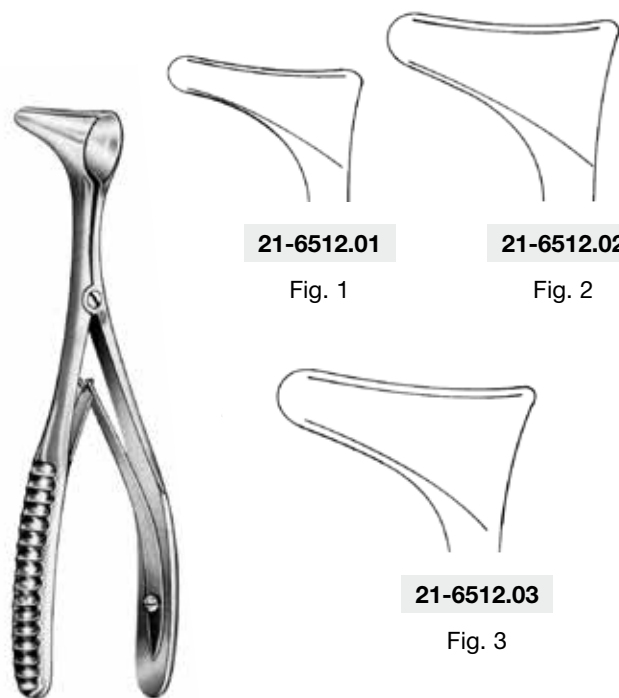

21-6512.01

Fig. 1

21-6512.02

Fig. 2

21-6512.03

Fig. 3

MOD. WIEN

21

Nasenspekula
Nasal Specula
Spéculums nasaux
Espéculos nasales



leichtes Modell
 lightweight model
 model léger
 modelo ligero

MOD. WIEN

21-6513.03



TIECK-HALLE

21-6516.13

13,5 cm, 5 1/4"



YANKAUER

21-6531.19

19 cm, 7 1/2"



KILLIAN

13 cm, 5"

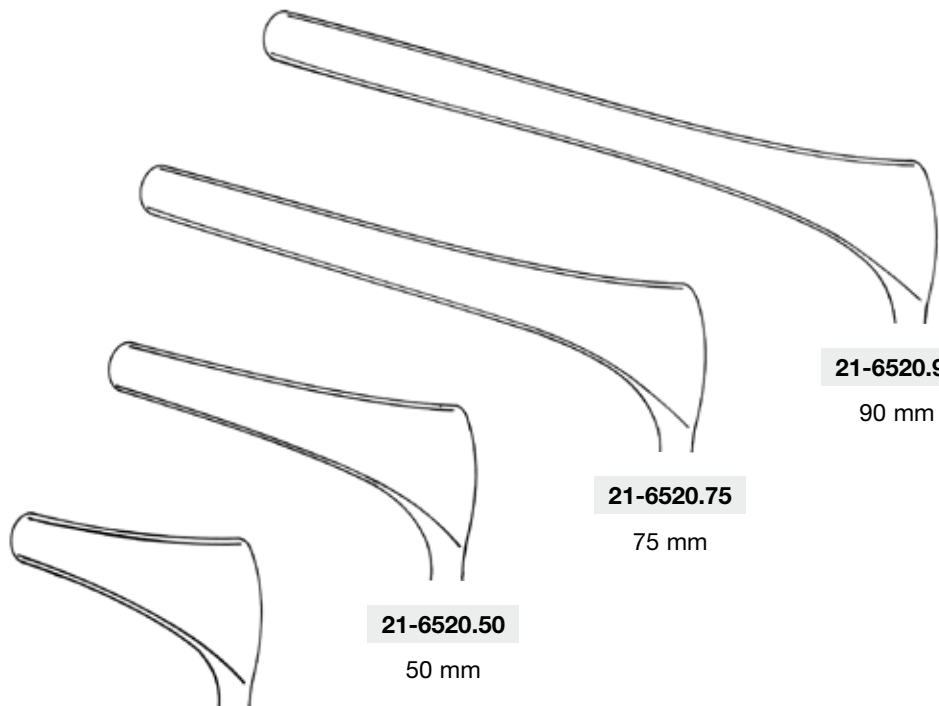

21-6520.90

90 mm

21-6520.75

75 mm

21-6520.50

50 mm

21-6520.35

35 mm

Nasenspekula
 Nasal Specula
 Spéculum nasaux
 Espéculos nasales

21



COTTLE

14 cm, 5 1/2"

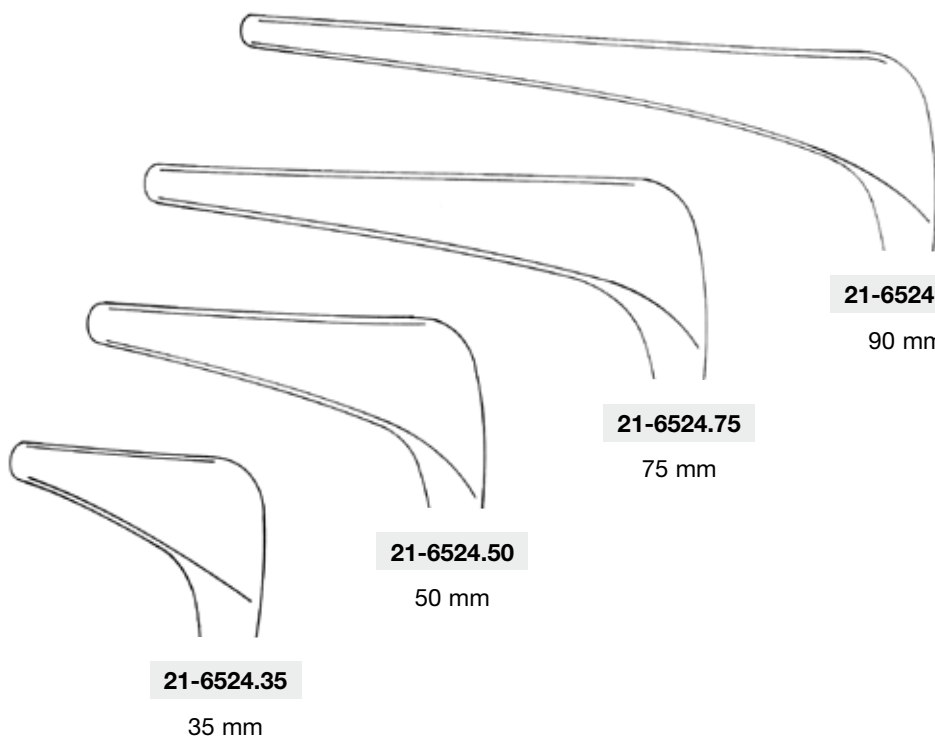

21-6524.90

90 mm

21-6524.75

75 mm

21-6524.50

50 mm

21-6524.35

35 mm



COTTLE

14 cm, 5 1/2"

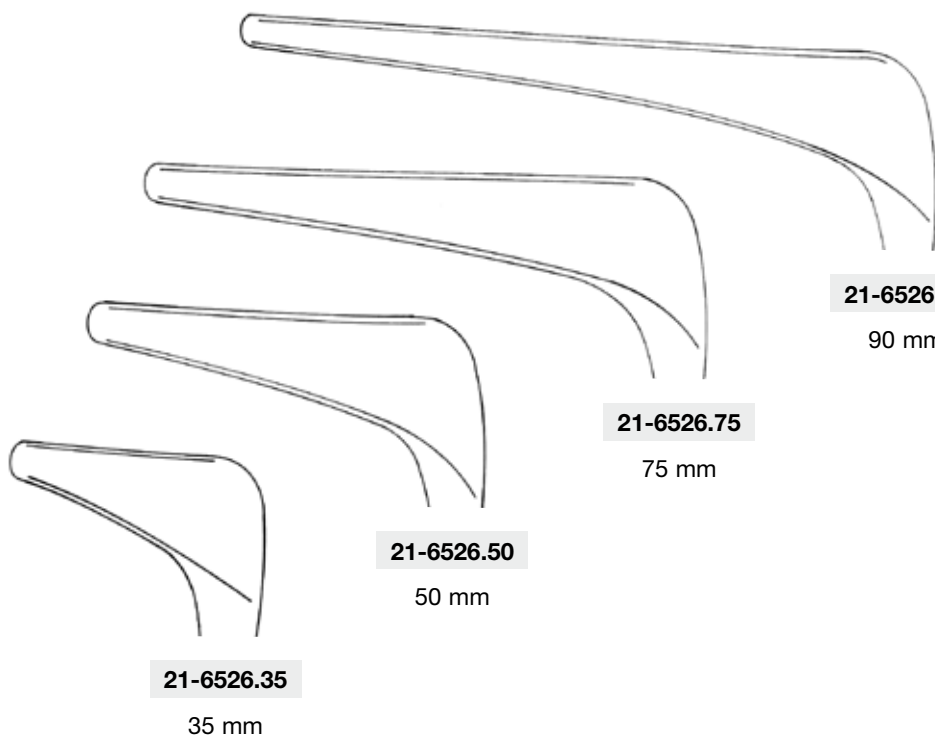

21-6526.90

90 mm

21-6526.75

75 mm

21-6526.50

50 mm

21-6526.35

35 mm



MICHEL



21-6539.12

12 mm



21-6539.14

14 mm



21-6539.16

16 mm



21-6539.18

18 mm



TROELTSCH

21-6551.15

15 cm, 5 3/4"

TROELTSCH

21-6551.18

18 cm, 7"



JANSEN

21-6554.20

20 cm, 8"

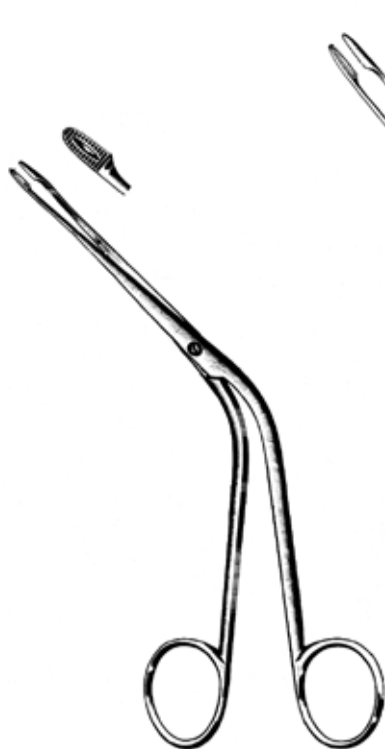

HARTMANN
 21-6561.16
 16 cm, 6 1/4"

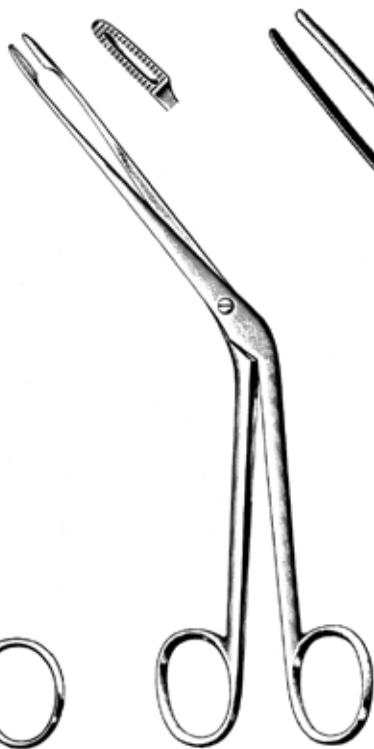

HARTMANN
 21-6561.20
 20 cm, 8"



LUBET-BARBON
 21-6565.20
 20 cm, 8"



LITTAUER
 21-6567.18
 18 cm, 7"



HEYMANN-KNIGHT
 21-6569.18
 18 cm, 7"

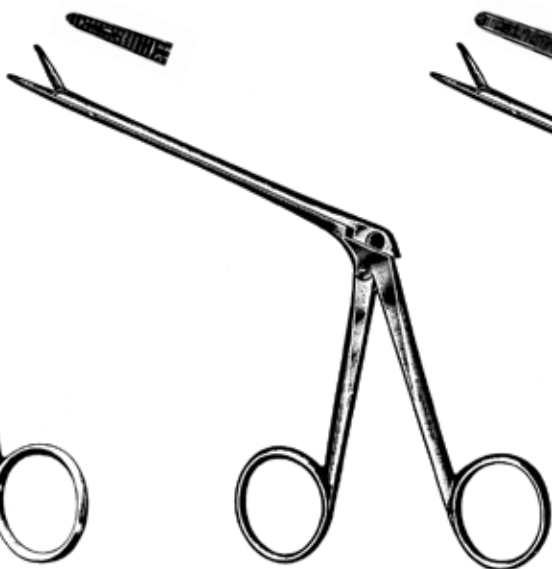

NOYES
 21-6571.14
 14,5 cm, 5 1/2"



NOYES
 21-6573.14
 14,5 cm, 5 1/2"

Scharfe Nasenzangen
Nasal Cutting Forceps
Pinces coupantes nasaux
Pinzas cortantes nasales

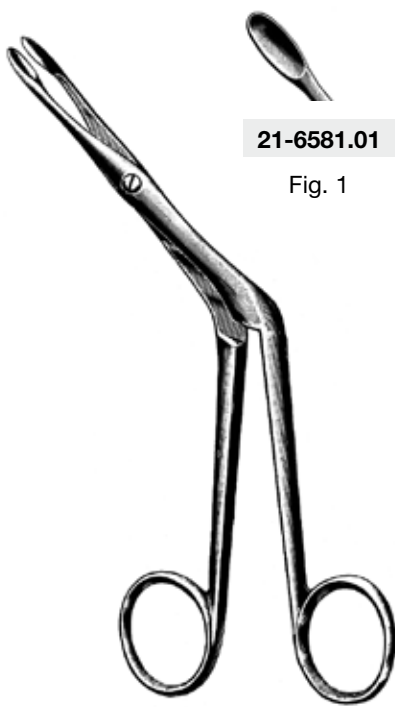

21-6581.01

Fig. 1



21-6581.02

Fig. 2



21-6581.03

Fig. 3

HEYMANN

18 cm, 7"

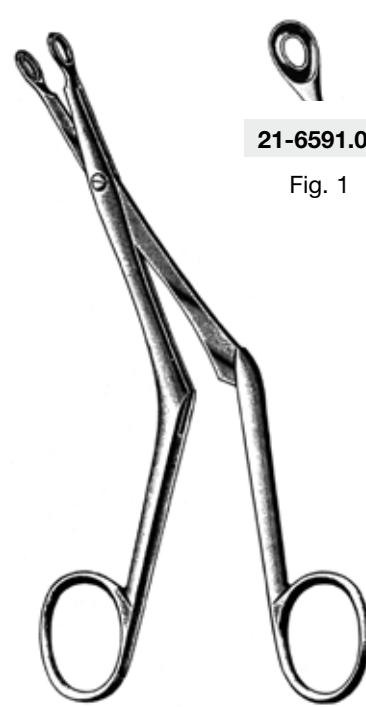

21-6591.01

Fig. 1



21-6591.02

Fig. 2



21-6591.03

Fig. 3



21-6591.04

Fig. 4

BRUENINGS

19 cm, 7 1/2"

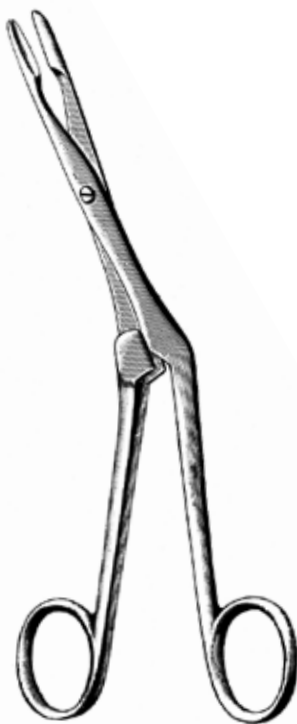

KNIGHT

21-6585.18

18 cm, 7"

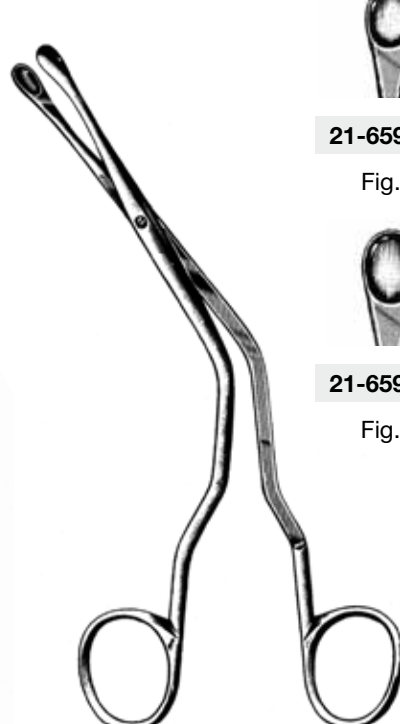

LUC

19 cm, 7 1/2"



21-6595.01

Fig. 1



21-6595.02

Fig. 2



LUC

19 cm, 7 1/2"



21-6597.01

Fig. 1



21-6597.02

Fig. 2

Scharfe Nasenzangen
Nasal Cutting Forceps
Pinces coupantes nasaux
Pinzas cortantes nasales

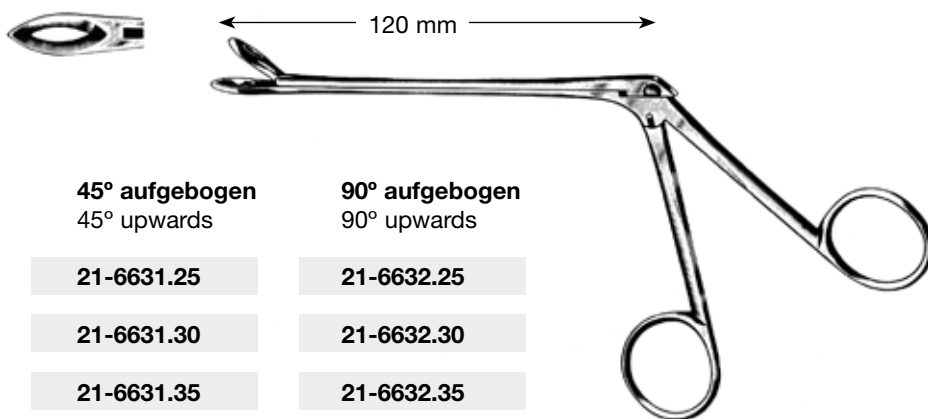

Maullänge jaw	gerade straight	45° aufgebogen 45° upwards	90° aufgebogen 90° upwards
2,5 mm	21-6630.25	21-6631.25	21-6632.25
3,0 mm	21-6630.30	21-6631.30	21-6632.30
3,5 mm	21-6630.35	21-6631.35	21-6632.35
4,0 mm	21-6630.40	21-6631.40	21-6632.40
5,0 mm	21-6630.50	21-6631.50	21-6632.40
6,0 mm	21-6630.60		

BLAKESLEY



STRUYCKEN

21-6631.01

Fig. 1



STRUYCKEN

21-6631.02

Fig. 2



MYLES

21-6637.05

5,0 mm



MYLES

21-6637.07

7,0 mm



MYLES

21-6637.09

9,0 mm



HARTMANN

21-6635.05

5,0 mm



HARTMANN

21-6635.07

7,0 mm



HARTMANN

21-6635.09

9,0 mm



HARTMANN

21-6635.11

11,0 mm

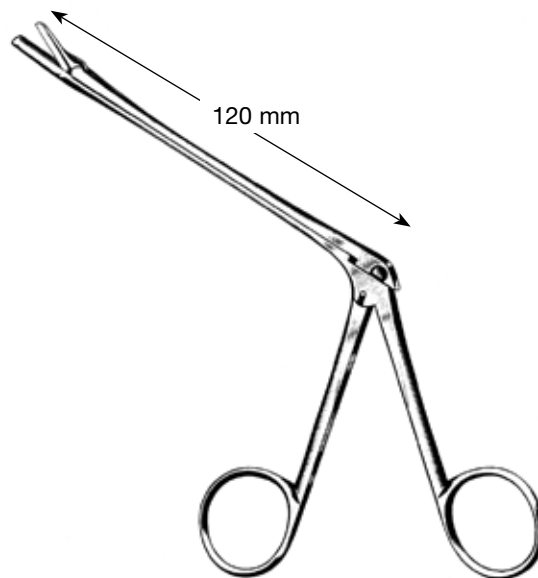

19 cm, 7 1/2"

21

Septum-Quetschzange
 Septum Crushing Forceps
 Pince à écraser la cloison
 Pinza para magullar tabique



RUBIN
 21-6651.21
 21 cm, 8 1/4"



HAJEK-CLAUS
 21-6720.20
 20 cm, 8"

- 21-6703.03 3 x 3 mm
- 21-6703.04 4 x 4 mm
- 21-6703.05 5 x 5 mm
- 21-6703.06 6 x 6 mm

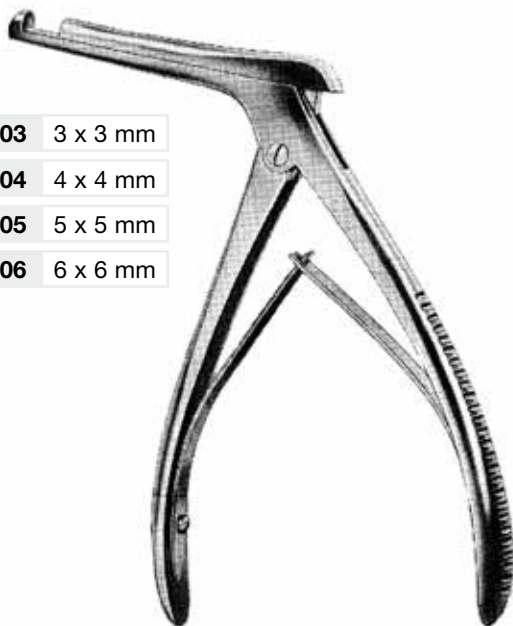

KERRISON
 9 cm, 3 1/2"

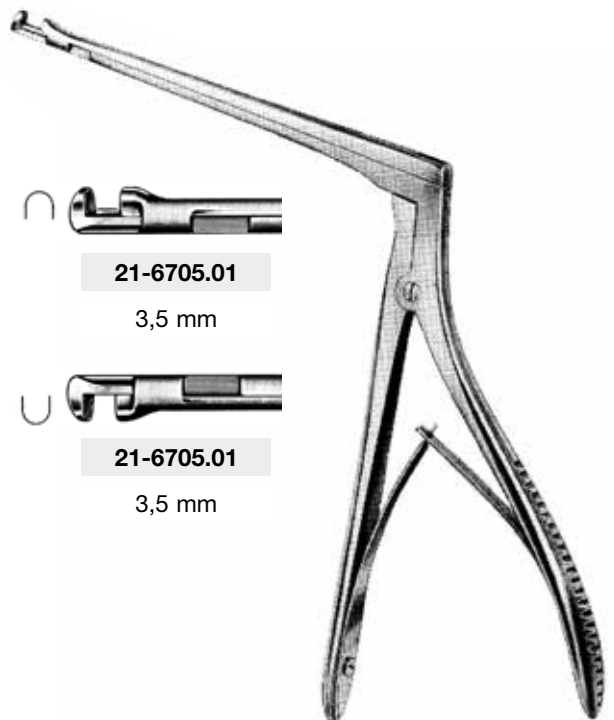

- 21-6705.01
3,5 mm
- 21-6705.01
3,5 mm

HAJEK-KOFLER

- 21-6711.10 1,0 mm
- 21-6711.25 2,5 mm
- 21-6711.40 4,0 mm

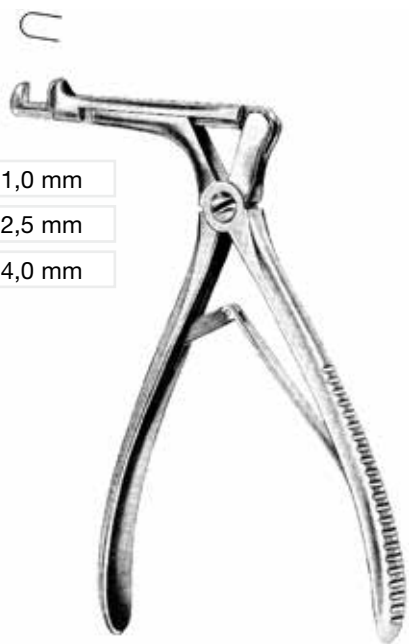

CITELLI



BEYER
 21-6715.20

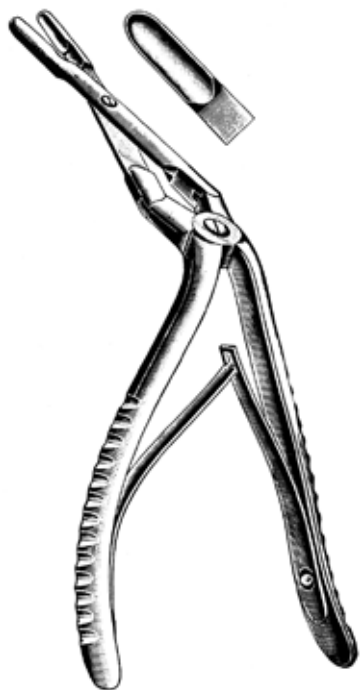

MIDDLETON-JANSEN
 21-6723.19
 19 cm, 7 1/2"



MIDDLETON-JANSEN
 21-6725.19
 19 cm, 7 1/2"



- 21-6740.15 Ø 1,5 mm
- 21-6740.18 Ø 1,8 mm
- 21-6740.20 Ø 2,0 mm

LICHTWITZ

10 cm, 4"

3,0 mm



KILLIAN

21-6741.03

14 cm, 5 1/2"



KRAUSE

21-6751.26

26 cm, 10 1/4"



WILDE

21-6752.24

24 cm, 9 1/2"

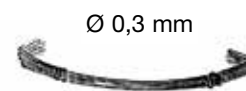

Ø 0,3 mm

21-6755.03

Dtzd. /doz. / douz / doc.

Nasenmesser
Nasal Knives
Bistouris nasaux
Bisturries nasales



JOSEPH



spitz
pointed
pointu
agudo



21-6772.16

21-6773.16



stumpf
blunt
mousse
romo



21-6770.16

21-6771.16



FREER

21-6774.15

15 cm, 5 3/4"



FREER

21-6775.19

19 cm, 7 1/2"



JOSEPH

21-6776.16

16 cm, 6 1/4"



CONVERSE

21-6779.16

16 cm, 6 1/4"



COTTLE

21-6780.15

15 cm, 5 3/4"

21

Nasenmesser, Septummesser
Nasal Knives, Septum Knives
Bistouris nasaux, Couteaux pour la cloison de nez
Bisturios nasales, Cuchillos para tabique nasal



COTTLE

21-6782.15

15 cm, 5 3/4"



COTTLE

21-6784.15

15 cm, 5 3/4"



COTTLE

21-6785.15

15 cm, 5 3/4"



BRUENINGS

21-6798.16

16,5 cm, 6 1/2"



BALLENGER

20 cm, 8"



21-6790.03

3,0 mm



21-6790.04

4,0 mm



21-6790.05

5,0 mm



BALLENGER

20 cm, 8"



21-6792.03

3,0 mm



21-6792.04

4,0 mm



21-6792.05

5,0 mm

Septum-Elevatorien
Septum Elevators
Élévateurs pour la cloison de nez
Elevadores para tabique nasal



21-6810.04

4,0 mm

MC KENTY

15 cm, 5 3/4"



21-6810.05

5,0 mm

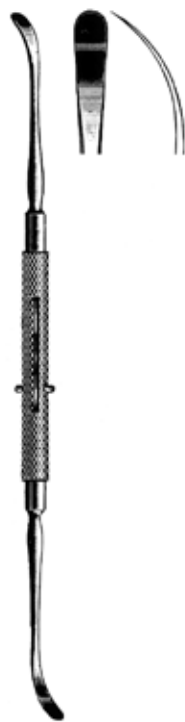

ROGER

21-6813.19

19 cm, 7 1/2"



FREER

21-6815.18

18 cm, 7"



FREER

21-6817.19

19 cm, 7 1/2"



FREER

21-6819.19

19 cm, 7 1/2"

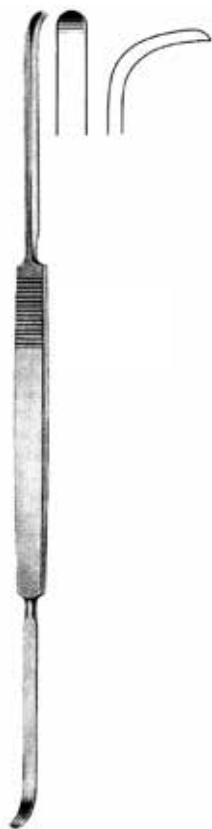

COTTLE

21-6821.23

23 cm, 9"



COTTLE

21-6823.22

22 cm, 8 1/2"



KILLIAN

21-6826.22

22 cm, 8 1/2"

21

Septum-Elevatorien, Nasenplastik-Meißel

Septum Elevators, Rhinoplastic Chisels

Élévateurs pour la cloison de nez, Ciseaux-burins pour la plastique de nez

Elevadores para tabique, Cinceles para la plástica nasal



JOSEPH
21-6825.16
16 cm, 6 1/4"



COTTLE
21-6825.19
19 cm, 7 1/2"

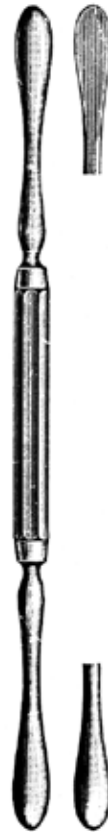

HAJEK-BALLENGER
21-6828.21
22 cm, 8 1/2"



BALLENGER
21-6830.22
22 cm, 8 1/2"



FREER
21-6850.04



FREER
21-6851.04



21-6854.04 4 mm
21-6854.07 7 mm
21-6854.09 9 mm
21-6854.12 12 mm

COTTLE
18 cm, 7"



COTTLE
21-6855.06
18 cm, 7"

Nasenplastik-Meißel
Rhinoplastic Chisels
Ciseaux-burins pour la plastique de nez
Cinceles para la plástica nasal

21



21-6858.04	4 mm
21-6858.07	7 mm
21-6858.09	9 mm
21-6858.12	12 mm

COTTLE



21-6860.04	4 mm
21-6860.07	7 mm
21-6860.12	12 mm

COTTLE
18 cm, 7"



21-6870.04	4 mm
21-6870.05	5 mm
21-6870.06	6 mm
21-6870.07	7 mm

FOMON
17 cm, 6 3/4"

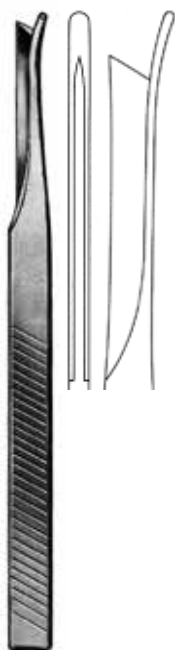

SILVER
21-6873.01
18 cm, 7"

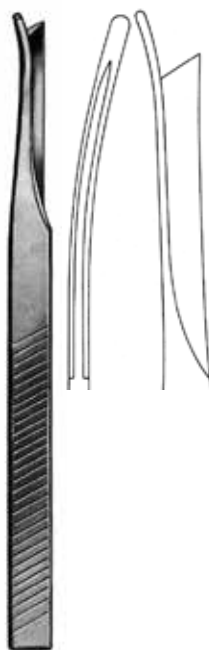

SILVER
21-6873.02
18 cm, 7"



SILVER
21-6873.03
18 cm, 7"

Nasenplastik-Meißel
Rhinoplastic Chisels
Ciseaux-burins pour la plastique de nez
Cinceles para la plástica nasal



21-6872.10	10 mm
21-6872.12	12 mm
21-6872.14	14 mm
21-6872.16	16 mm

CINELLI

17 cm, 6 3/4"



21-6884.04	4 mm
21-6884.06	6 mm
21-6884.08	8 mm

BALLENGER

15 cm, 6"



KILLIAN-CLAUS

21-6882.05

17 cm, 6 3/4"



WEST

21-6886.16

16 cm, 6 1/4"



WEST

21-6887.16

16 cm, 6 1/4"

6 mm



FREER

21-6889.16

16 cm, 6 1/4"

Nasenraspeln
Nasal Rasps
Râpes nasaux
Raspas nasales

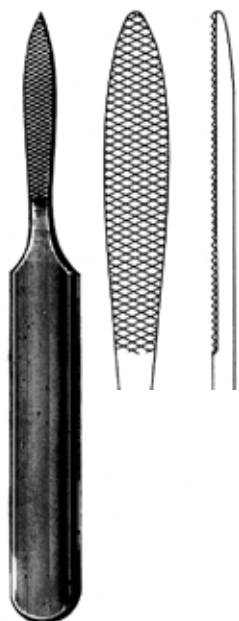

JOSEPH

21-6902.16

16 cm, 6 1/4"

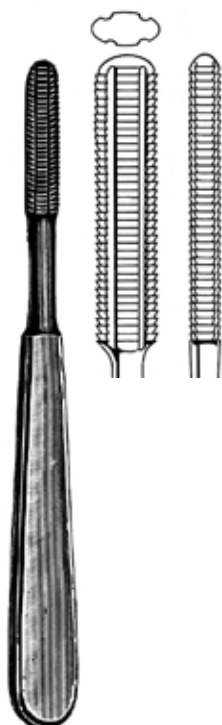

AUFRICHT

21-6904.18

18 cm, 7"



LEWIS

18 cm, 7"

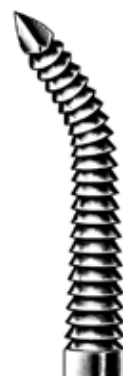

21-6907.18

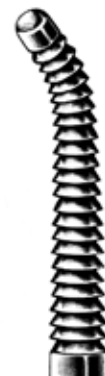

21-6907.19

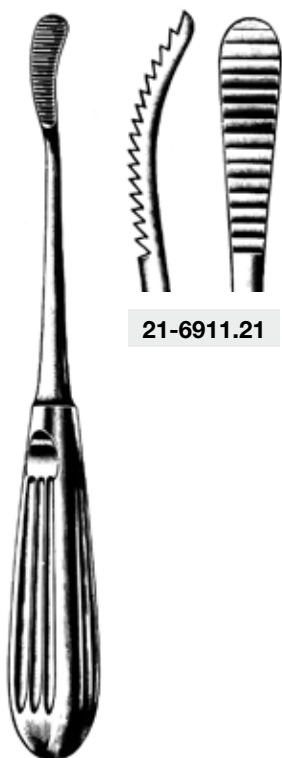

WIENER

21 cm, 8 1/4"

21-6911.21

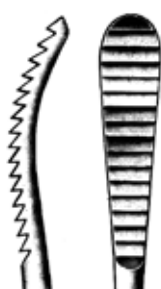

21-6913.21



JOSEPH

18 cm, 7"

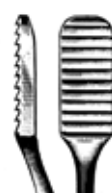

21-6914.16



21-6916.16

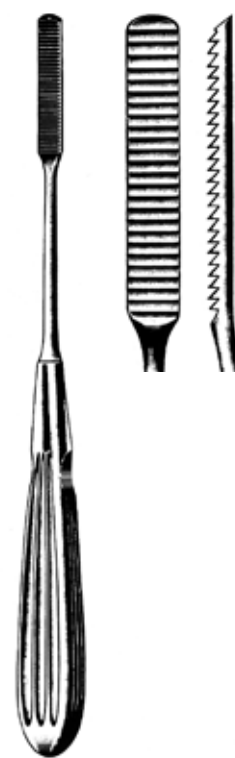

MALTZ (COTTLE)

21-6918.21

21 cm, 8 1/4"

Nasenraspeln
Nasal Rasps
Rapes nasals
Raspas nasales

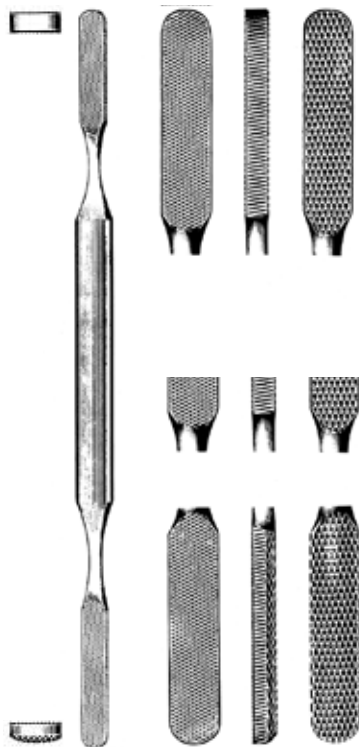

FOMON

21-6920.21

21 cm, 8 1/4"



GALLAHER

21-6926.16

Fig. 1



21-6927.16

Fig. 2

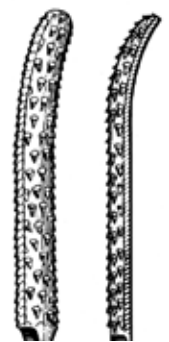

21-6929.16

Fig. 3



FOMON

20 cm, 8"

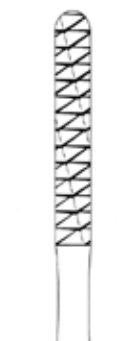

21-6922.01

Fig. 1/2



21-6922.03

Fig. 3/4



21-6922.05

Fig. 5/6



21-6922.07

Fig. 7/8



21-6922.09

Fig. 9/10



21-6932.19

21-6934.19

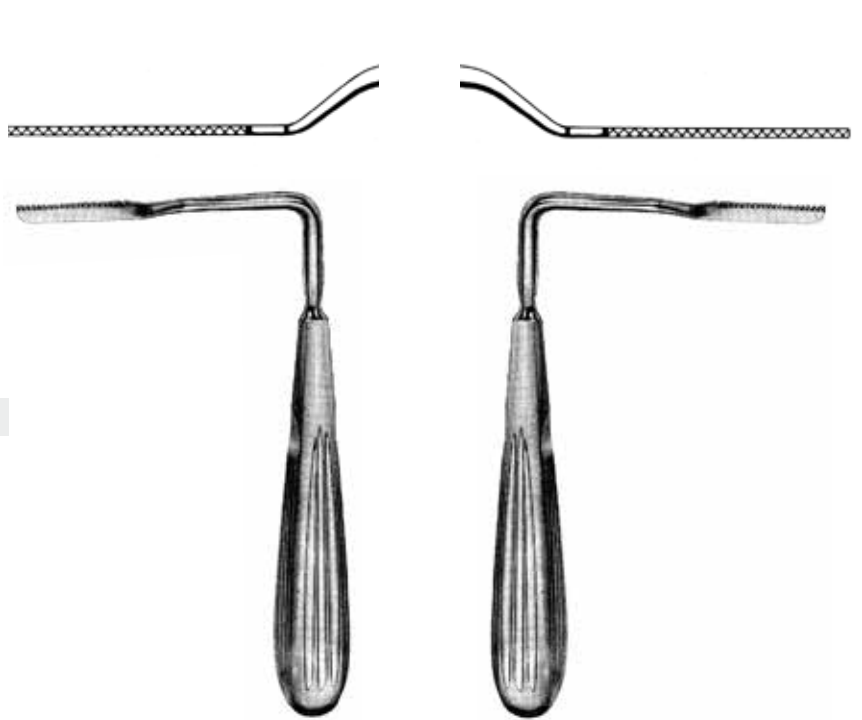

JOSEPH

21-6935.01

17 cm, 6 3/4"

JOSEPH

21-6935.02

17 cm, 6 3/4"

JOSEPH

19 cm, 7 1/2"



COTTLE

21-6956.14

14 cm, 5 1/2"



FOMON

21-6956.16

16 cm, 6 1/4"



FOMON

21-6957.17

17 cm, 6 3/4"



COTTLE-NEIVERT

21-6959.20

20 cm, 8"



GILLIES

18 cm, 7"

?
 21-6960.18
 Fig. 1

?
 21-6962.18
 Fig. 2



AUFRICHT
21-6951.16
16 cm, 6 1/4"



JATHO
21-6995.15
15 cm, 5 3/4"



ASCH
21-6971.23
23 cm, 9"



WALSHAM
23 cm, 9"



21-6972.23



21-6973.23



21-6975.23



FAULKNER

21-7001.21

21 cm, 8 1/4"



COAKLEY

17 cm, 6 3/4"



21-7007.01

Fig. 1



21-7007.02

Fig. 2



21-7007.03

Fig. 3



21-7007.04

Fig. 4



21-7007.05

Fig. 5



21-7007.06

Fig. 6



BECKMANN

22 cm, 8 1/2"



21-7020.01

Fig. 1



21-7020.02

Fig. 2



21-7020.03

Fig. 3



21-7020.04

Fig. 4



21-7020.05

Fig. 5



21-7020.06

Fig. 6



BARNHILL

21 cm, 8 1/4"



21-7030.01

Fig. 1



21-7030.02

Fig. 2



21-7030.03

Fig. 3



21-7030.04

Fig. 4



ST. CLAIR-THOMSON

21 cm, 8 1/4"



21-7036.01

Fig. 1



21-7036.02

Fig. 2



21-7036.03

Fig. 3



21-7036.04

Fig. 4



21-7041.01

Fig. 1

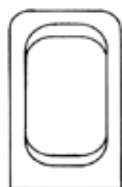

21-7041.02

Fig. 2



21-7041.03

Fig. 3

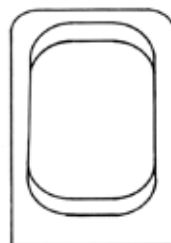

mit ungelochter Klinge
 with unperforated blade
 à lame non-perforée
 con hoja no perforada

LA FORCE

25 cm, 10"

21-7042.01

Fig. 1

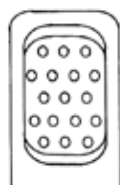

21-7042.02

Fig. 2

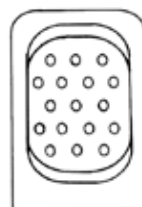

21-7042.03

Fig. 3

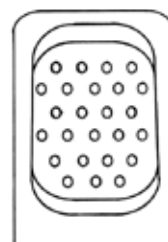

Ersatzklingen, gelocht
 Spare Blades, perforated
 Lames de rechange perforées
 Hojas de repuesto, perforadas

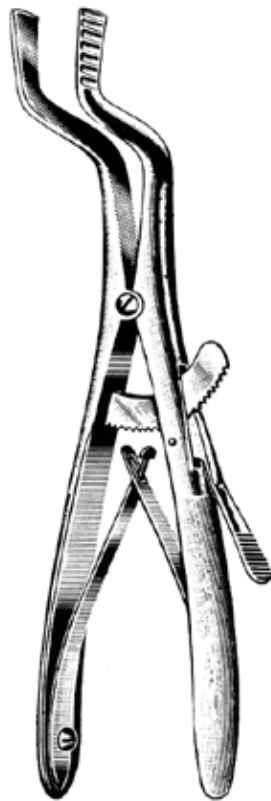

Zungenspatel, Lippenhalter
Tongue Depressors, Lip Retractors
Abaisse-langues, écarteurs des lèvres
Abajalenguas, Separadores de labios

22



22-7502.16
16 cm, 6 1/4"



FRENZEL
22-7505.16
16,5 cm, 6 1/2"



BRUENINGS
22-7507.19
19 cm, 7 1/2"



BUCHWALD
22-7509.19
19 cm, 7 1/2"

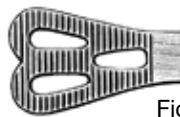

Fig. 1

22-7515.01
14 cm, 5 1/2"

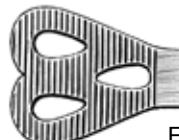

Fig. 2

22-7515.02
15 cm, 5 3/4"



HARTMANN
22-7511.15
15 cm, 5 3/4"



WIEDER
14 cm, 5 1/2"



ANDREW
22-7517.11
11 cm, 4 1/4"

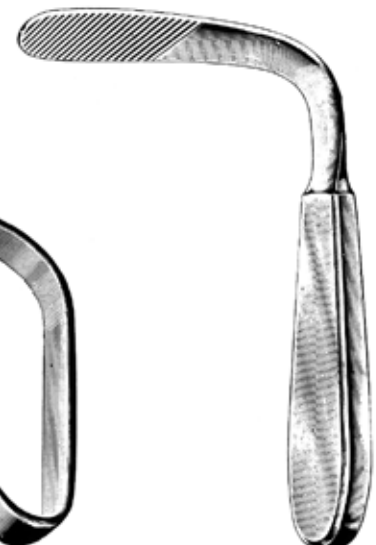

TOBOLD
22-7519.14
14,5 cm, 5 1/2"

Zungenspatel, Lippenhalter
Tongue Depressors, Lip Retractors
Abaisse-langues, écarteurs des lèvres
Abajalenguas, Separadores de labios



STERNBERG

22-7527.14 14 cm, 5 1/2"

22-7527.16 16 cm, 6 1/4"

22-7527.18 18 cm, 7"



STERNBERG

22-7529.12 12 cm, 4 3/4"

22-7529.14 14 cm, 5 1/2"

22-7529.16 16 cm, 6 1/4"



22-7530.11

11 cm, 4 1/4"



22-7535.19

19 cm, 7 1/2"

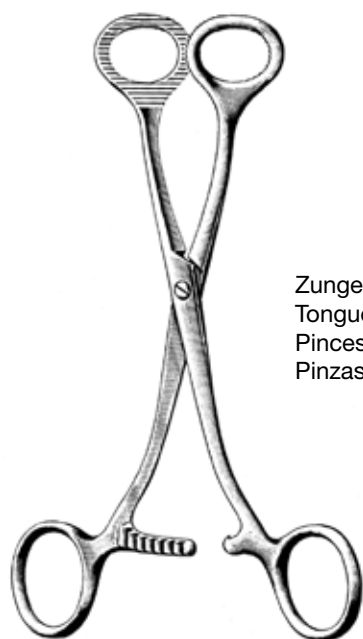

COLLIN

22-7550.16 16 cm, 6 1/4"

22-7550.18 18 cm, 7"

Zungenzangen
 Tongue Holding Forceps
 Pincas tire-langues
 Pinzas tiralenguas

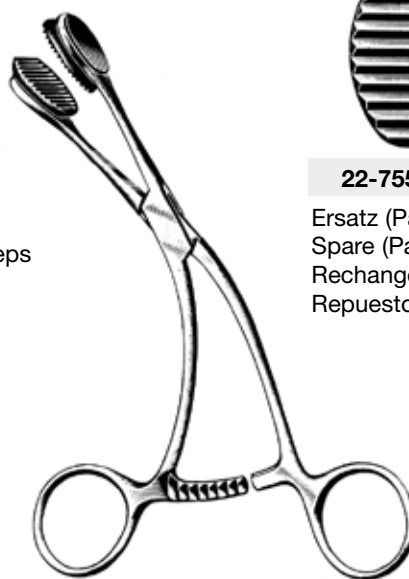

YOUNG

22-7555.16

16 cm, 6 1/4"



22-7555.99

Ersatz (Paar)
 Spare (Pair)
 Rechange (paire)
 Repuesto (pareja)



DOYEN-JANSEN (MOLT)

22-7565.12

12 cm, 4 3/4"



DOYEN-JANSEN (MOLT)

22-7565.14

14 cm, 5 1/2"



DENHART

22-7567.12

12 cm, 4 3/4"



HEISTER

22-7572.13

13 cm, 5"



ROSER-KOENIG

22-7570.16 16 cm, 6 1/4"

22-7570.19 19 cm, 7 1/2"



JENNINGS

22-7574.09 9 cm, 3 1/4"

22-7574.11 11 cm, 4 1/4"

22-7574.13 13 cm, 5"

22-7574.15 15 cm, 5 3/4"



SEEMANN-SEIFFERT

22-7585.09 9 cm, 3 1/4"

22-7585.11 11 cm, 4 1/4"

22-7585.13 13 cm, 5"

22-7585.15 15 cm, 5 3/4"

Mundsperrer
Mouth Gags
Ouvre-bouches
Abrebocas



WHITEHEAD

22-7580.11	11 cm, 4 1/4"
22-7580.13	13 cm, 5"
22-7580.15	15 cm, 5 3/4"



WHITEHEAD

22-7581.11	11 cm, 4 1/4"
22-7581.13	13 cm, 5"
22-7581.15	15 cm, 5 3/4"

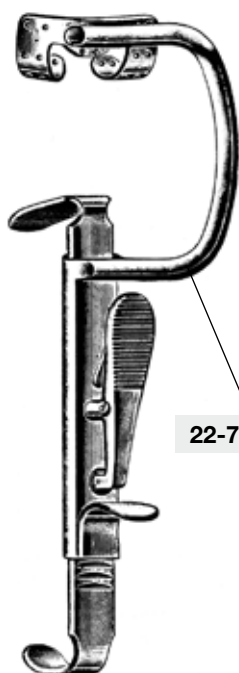

22-7610.10

DAVIS-BOYLE

22-7610.00

Set

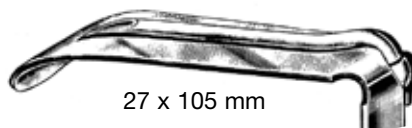

27 x 105 mm

22-7610.01

Fig. 1

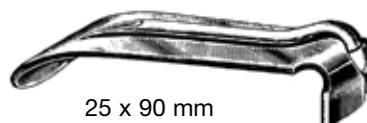

25 x 90 mm

22-7610.02

Fig. 2



25 x 75 mm

22-7610.03

Fig. 3



22 x 60 mm

22-7610.04

Fig. 4



20 x 25 mm

22-7610.05

Fig. 5



22-7615.10

KILNER-DOUGHTY

22-7615.00

Set



28 x 65 mm

22-7615.01

Fig. 1



32 x 75 mm

22-7615.02

Fig. 2



28 x 65 mm

22-7615.03

Fig. 3

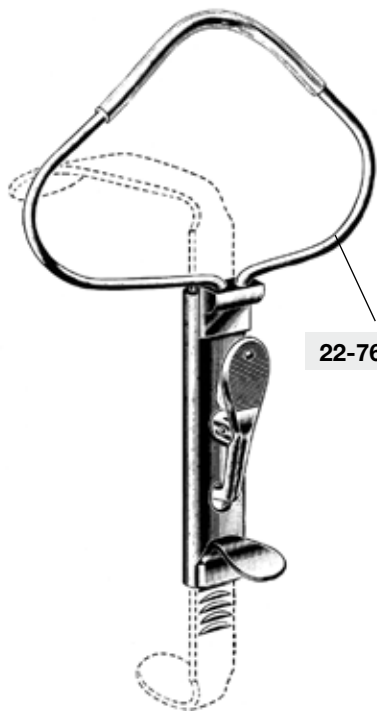

22-7620.10

MC IVOR

22-7620.00

Set

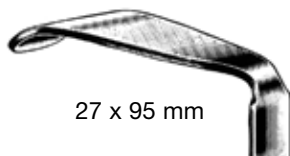

27 x 95 mm

22-7620.01

Fig. 1

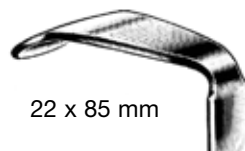

22 x 85 mm

22-7620.02

Fig. 2

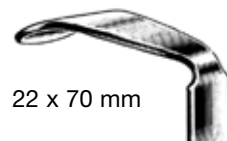

22 x 70 mm

22-7620.03

Fig. 3

Mund und Zunge
Mouth and Tongue
Bouche et langue
Boca y lengua



MAUNDER

22-7660.10

10 cm, 4 1/2"



PITHA

22-7665.10

10 cm, 4 1/2"



LANGENBECK

22-7671.01

Fig. 1



LANGENBECK

22-7671.02

Fig. 2



LANGENBECK

22-7671.03

Fig. 3



ROWE

22,5 cm, 8 3/4"
 Säuglinge / Infants / nourrissons / recién nacidos

23,5 cm, 9"
 Kinder / Children / enfants / niños

24 cm, 9 1/2"
 Erwachsene / Adults / adultes / adultos

links
 left side
 côté gauche
 izquierda

22-7701.22 22,5 cm, 8 3/4"

22-7701.23 23,5 cm, 9"

22-7701.24 24 cm, 9 1/2"



ROWE

rechts
 right side
 côté droit
 derecha

22-7703.22 22,5 cm, 8 3/4"

22-7703.23 23,5 cm, 9"

22-7703.24 24 cm, 9 1/2"

Tonsillen
Tonsils
Amygdales
Amígdalas

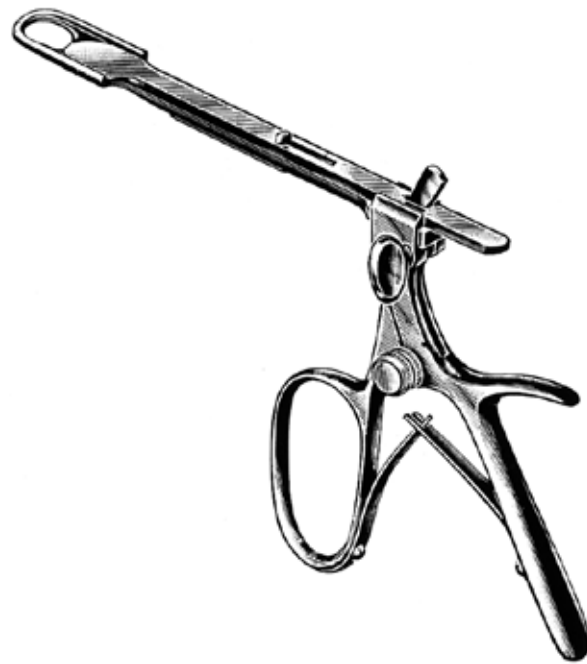

Tonsillen
Tonsils
Amygdales
Amígdalas

23



LOVE

23-7803.18 19 mm

23-7803.20 20 mm

23-7803.22 22 mm



HOFFER

23-7809.24

24 cm, 9 1/2"



NAGER

23-7811.23

23 cm, 9"

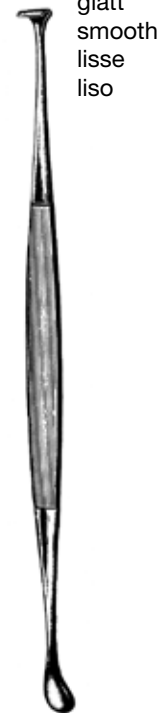

glatt
smooth
lisse
liso

HURD

23-7831.22

22 cm, 8 1/2"

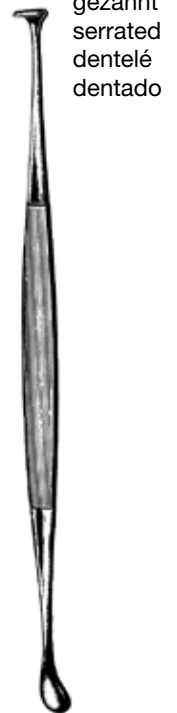

gezahnt
serrated
dentelé
dentado

HURD

23-7833.22

22 cm, 8 1/2"



HENKE

23-7835.23

23 cm, 9"

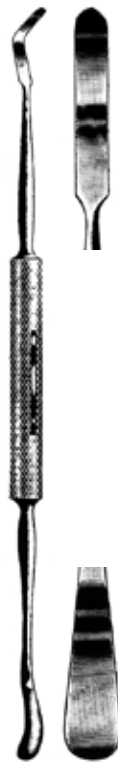

CARPENTER

23-7839.25

25 cm, 10"



CARPENTER

23-7843.24

24 cm, 9 1/2"

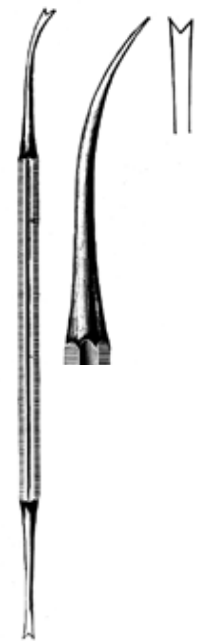

LUNIATSCHEK

23-7851.19

19 cm, 7 1/2"

Tonsillen
Tonsils
Amygdales
Amígdalas



DUPUY-WEISS

23-7865.22

22 cm, 8 1/2"



DUPUY-WEISS

23-7867.22

22 cm, 8 1/2"



SAWTEL

23-7881.19

19 cm, 7 1/2"



SAWTEL

23-7885.19

19 cm, 7 1/2"



SCHNIDT

23-7883.19

19 cm, 7 1/2"

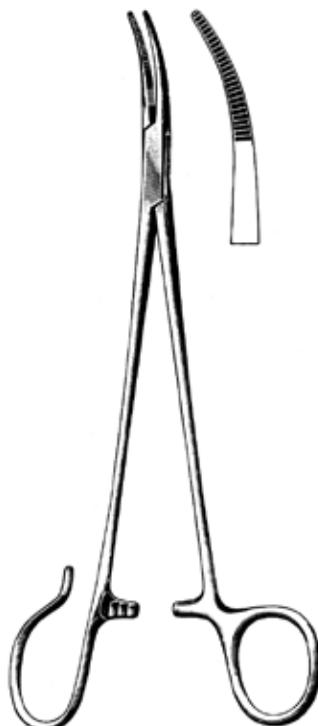

SCHNIDT

23-7887.19

19 cm, 7 1/2"

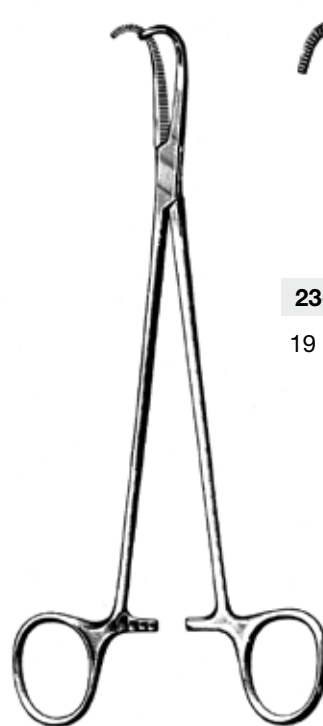

NEGUS



23-7891.19

19 cm, 7 1/2"

23-7893.19

19 cm, 7 1/2"

Tonsillen
Tonsils
Amygdales
Amígdalas

23



COLVER



23-7902.19
19 cm, 7 1/2"



23-7903.19
19 cm, 7 1/2"



WHITE

23-7905.18 18 cm, 7"

23-7905.23 23 cm, 9"



BALLENGER

23-7907.21

21,5 cm, 8 1/4"



BLOHMKE

23-7909.20

20 cm, 8"



TYDING

23-7911.21

21 cm, 8 1/4"

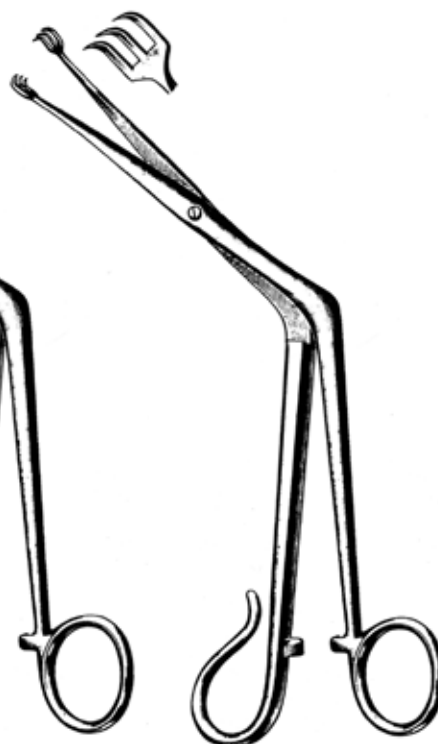

TIVNEN

23-7913.21

21 cm, 8 1/4"



MARSCHIK

23-7919.22

22 cm, 8 1/2"

Tonsillen
Tonsils
Amygdales
Amígdalas



CORWIN

23-7931.14

14 cm, 5 1/2"



EVES

23-7950.28

28 cm, 11"



EVES

23-7952.28

28 cm, 11"



BRUENINGS

23-7956.28

28 cm, 11"

in Packungen zu 100 Stück
in packages of 100 pieces
en paquets de 100 pièces
en paquets de 100 piezas



23-7957.40 40 mm

23-7957.50 50 mm

in Packungen zu 12 Stück
in packages of 12 pieces
en paquets de 12 pièces
en paquets de 12 piezas



23-7959.03

Ø 0,3 mm

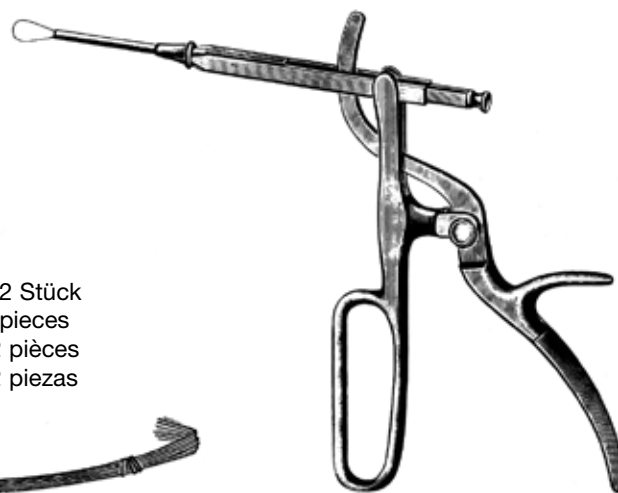

TYDING

23-7960.00

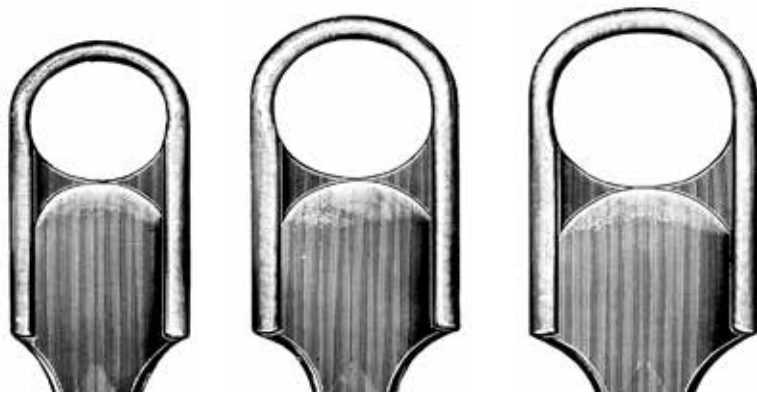

mit 3 Aufsätzen
with 3 blades
avec 3 lames
con 3 hojas

SLUDER-BALLENGER

23-7970.00



23-7990.02 2 ml

23-7990.05 5 ml

23-7990.10 10 ml



23-7993.00



23-7993.45

45°



23-7993.90

90°

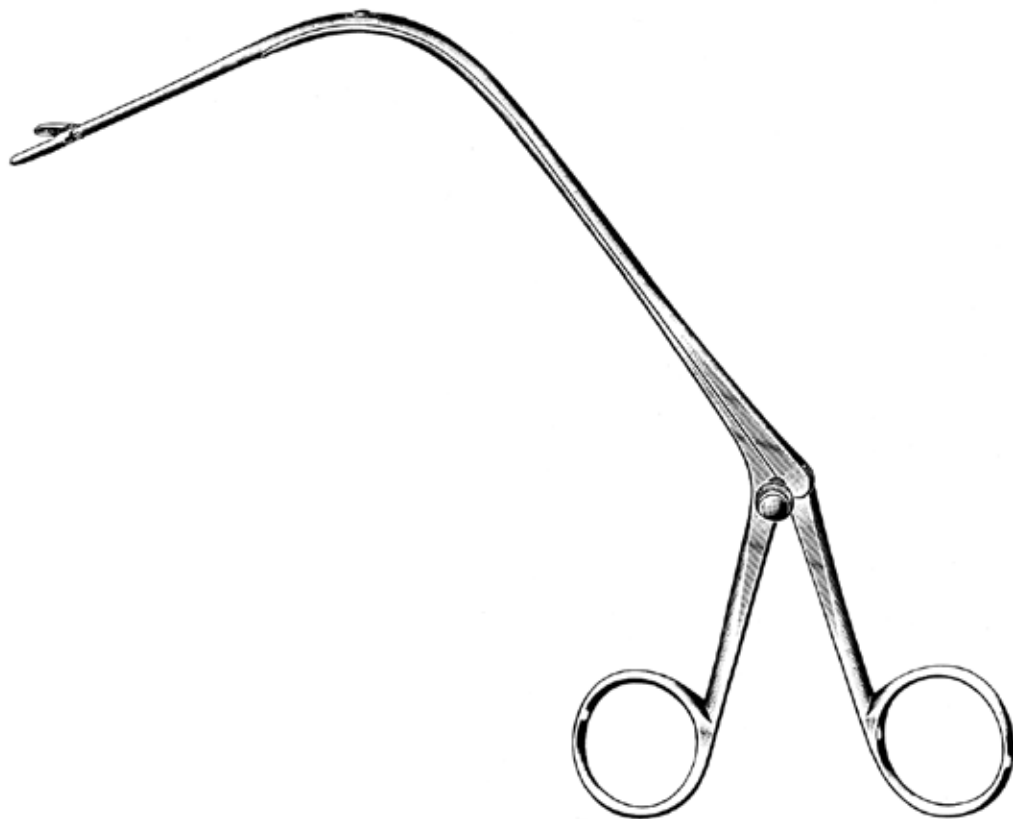



JACKSON

22 cm, 8 1/2"



24-8001-22

22 cm, 8 1/2"



24-8003-22

22 cm, 8 1/2"

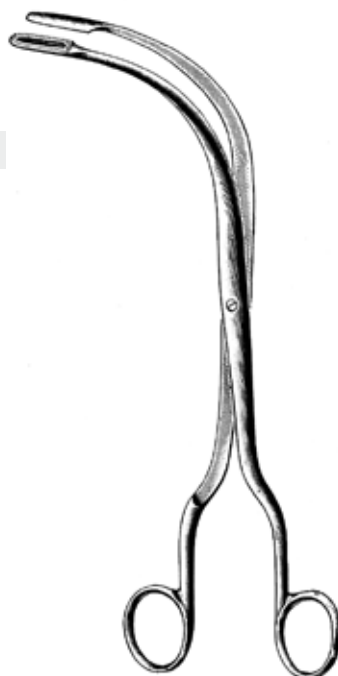

FRAENKEL

24-8011.18

18 cm, 7"



REICHERT

24-8021.24

24 cm, 9 1/2"



24-8015.01

Fig. 1



24-8015.02

Fig. 2



24-8015.03

Fig. 3



24-8015.04

Fig. 4

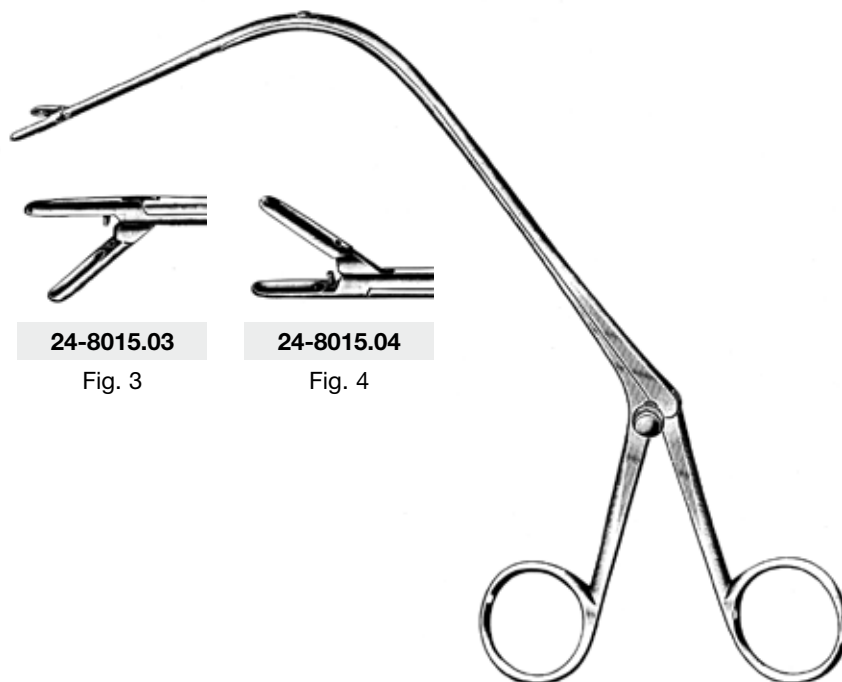

JURASZ

18 cm, 7"

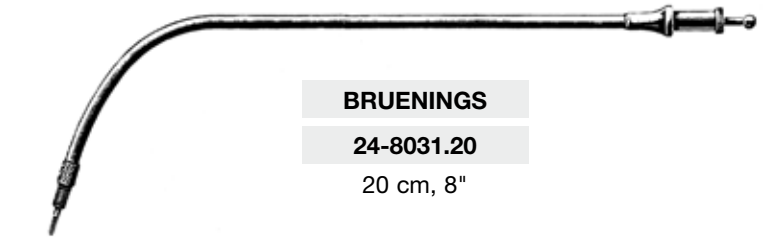

BRUENINGS

24-8031.20

20 cm, 8"



BRUENINGS

24-8032.20 20 cm, 8"

24-8032.30 30 cm, 12"

24-8032.40 40 cm, 16"

24-8032.50 50 cm, 20"

24-8032.60 60 cm, 24"



HUBER

24-8030.00



FRAENKEL

24-8050.00



SEIFFERT

24-8052.00



FRAENKEL

24-8054.00



SCHEINMANN

24-8055.00



SCHEINMANN

⊕ 24-8057.00



BRUENINGS

○ 24-8058.02

○ 24-8058.03



BRUENINGS

○ 24-8060.02

○ 24-8060.03



LANGE

24-8062.00



KRAUSE

⊕ 24-8064.01

⊕ 24-8064.02



KRAUSE

⊕ 24-8066.00



CORDES

⊖ 24-8068.01

⊖ 24-8068.02

⊖ 24-8068.03

⊖ 24-8068.04



SCHUMACHER

△ 24-8070.00



CORDES

⊖ 24-8072.01

⊖ 24-8072.02



CORDES

⊕ 24-8074.00



ROSENBERG

24-8076.00



CHEVALIER-JACKSON



	Fig. 1	Fig. 2	Fig. 3	Fig. 4	Fig. 5	Fig. 6	Fig. 7
30 cm, 12"	24-8130.01	24-8130.02	24-8130.03	24-8130.04	24-8130.05	24-8130.06	24-8130.07
40 cm, 16"	24-8140.01	24-8140.02	24-8140.03	24-8140.04	24-8140.05	24-8140.06	24-8140.07
50 cm, 20"	24-8150.01	24-8150.02	24-8150.03	24-8150.04	24-8150.05	24-8150.06	24-8150.07
60 cm, 24"	24-8160.01	24-8160.02	24-8160.03	24-8160.04	24-8160.05	24-8160.06	24-8160.07



24-8170.08	Fig. 00	8 mm
24-8170.10	Fig. 0	10 mm
24-8170.12	Fig. 1	12 mm
24-8170.14	Fig. 2	14 mm
24-8170.16	Fig. 3	16 mm
24-8170.18	Fig. 4	18 mm
24-8170.20	Fig. 5	20 mm
24-8170.22	Fig. 6	22 mm
24-8170.24	Fig. 7	24 mm
24-8170.26	Fig. 8	26 mm
24-8170.28	Fig. 9	28 mm
24-8170.30	Fig. 10	10 mm



24-8172.08	Fig. 00	8 mm
24-8172.10	Fig. 0	10 mm
24-8172.12	Fig. 1	12 mm
24-8172.14	Fig. 2	14 mm
24-8172.16	Fig. 3	16 mm
24-8172.18	Fig. 4	18 mm
24-8172.20	Fig. 5	20 mm
24-8172.22	Fig. 6	22 mm
24-8172.24	Fig. 7	24 mm
24-8172.26	Fig. 8	26 mm
24-8172.28	Fig. 9	28 mm
24-8172.30	Fig. 10	10 mm



24-8174.12



24-8176.10





Ø 1,8 mm	160 cm	25-1110.16	25-1111.16	25-1112.16	25-1113.16
	230 cm	25-1110.23	25-1111.23	25-1112.23	25-1113.23



Ø 2,2 mm	160 cm	25-1120.16	25-1121.16	25-1122.16	25-1123.16
	230 cm	25-1120.23	25-1121.23	25-1122.23	25-1123.23



Ø 2,6 mm	160 cm	25-1130.16	25-1131.16
	230 cm	25-1130.23	25-1131.23



Ø 3,4 mm	160 cm	25-1140.16	25-1141.16	25-1142.16	25-1143.16
	230 cm	25-1140.23	25-1141.23	25-1142.23	25-1143.23



Ø 1,8 mm	160 cm	25-1110.26	25-1111.26	25-1112.26	25-1113.26
	230 cm	25-1110.33	25-1111.33	25-1112.33	25-1113.33



Ø 2,2 mm	160 cm	25-1120.26	25-1121.26	25-1122.26	25-1123.26
	230 cm	25-1120.33	25-1121.33	25-1122.33	25-1123.33

25

Gastroskopie
Gastroscopy
Gastroscopia
Gastroscopia



Ø 1,8 mm	160 cm	25-1216.16
	230 cm	25-1216.23



Ø 2,2 mm	160 cm	25-1222.16
	230 cm	25-1222.23



Ø 2,6 mm	160 cm	25-1232.16
	230 cm	25-1232.23



Ø 3,4 mm	160 cm	25-1242.16
	230 cm	25-1242.23



Ø 1,8 mm	160 cm	25-1301.16	25-1302.16	25-1304.16	25-1311.16
	230 cm	25-1301.23	25-1302.23	25-1304.23	25-1311.23



Ø 1,8 mm	160 cm	25-1312.16	25-1313.16	25-1314.16
	230 cm	25-1312.23	25-1313.23	25-1314.23



Ø 2,2 mm	160 cm	25-1291.16	25-1292.16	25-1341.16	25-1342.16
	230 cm	25-1291.23	25-1292.23	25-1341.23	25-1342.23



Ø 2,2 mm	160 cm	25-1343.16	25-1344.16	25-1351.16	25-1352.16
	230 cm	25-1343.23	25-1344.23	25-1351.23	25-1352.23



Ø 2,2 mm	160 cm	25-1353.16	25-1354.16
	230 cm	25-1353.23	25-1354.23



Ø 1,8 mm	160 cm	25-1301.26	25-1302.26
	230 cm	25-1301.33	25-1302.33



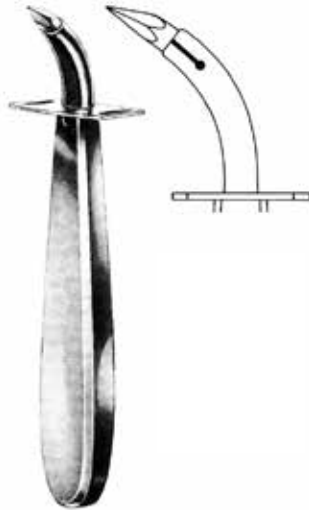

UCKERMANN

13 cm, 5"

26-1075.75

7,5 mm

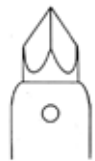

26-1075.90

9,0 mm

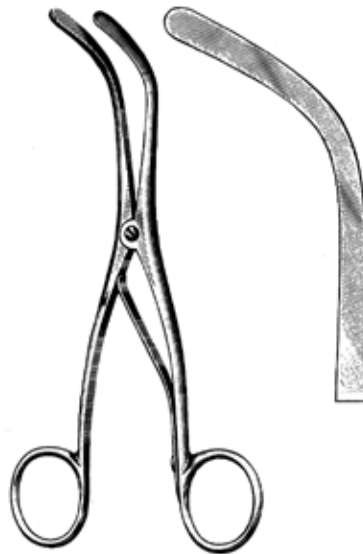

TROUSSEAU

26-1114.14

14 cm, 5 1/2"

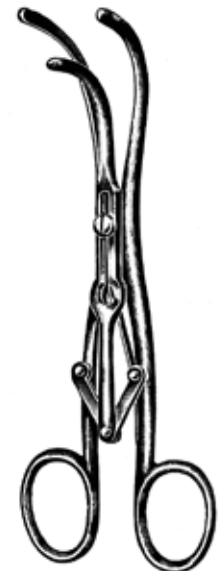

LABORDE

26-1113.14

14 cm, 5 1/2"



BOSE

26-1115.07

7 cm, 2 3/4"



JACKSON

26-1116.15

15 cm, 5 3/4"



JACKSON

26-1117.17

17 cm, 6 3/4"



ITERSON

26-1118.16

16 cm, 6 1/4"

26-1118.16

26-1119.16

Tracheotomie
Tracheostomy
Trachéotomie
Traqueotomía



BOSE

26-1122.16

16 cm, 6 1/4"



BOSE

26-1124.16

16 cm, 6 1/4"



ROSE

26-1130.13

13 cm, 5"



WAGENER-MOSHER

26-1151.05 5 mm

26-1151.07 7 mm

26-1151.09 9 mm



LUER

26-1220.04 4 mm Fig. 0

26-1220.05 5 mm Fig. 1

26-1220.06 6 mm Fig. 2

26-1220.07 7 mm Fig. 3

26-1220.08 8 mm Fig. 4

26-1220.09 9 mm Fig. 5

26-1220.10 10 mm Fig. 6

26-1220.11 11 mm Fig. 7

26-1220.12 12 mm Fig. 8

26-1220.13 13 mm Fig. 9



JACKSON

26-1240.04 4 mm Fig. 0

26-1240.05 5 mm Fig. 1

26-1240.06 6 mm Fig. 2

26-1240.07 7 mm Fig. 3

26-1240.08 8 mm Fig. 4

26-1240.09 9 mm Fig. 5

26-1240.10 10 mm Fig. 6

26-1240.11 11 mm Fig. 7

26-1240.12 12 mm Fig. 8

26-1240.13 13 mm Fig. 9

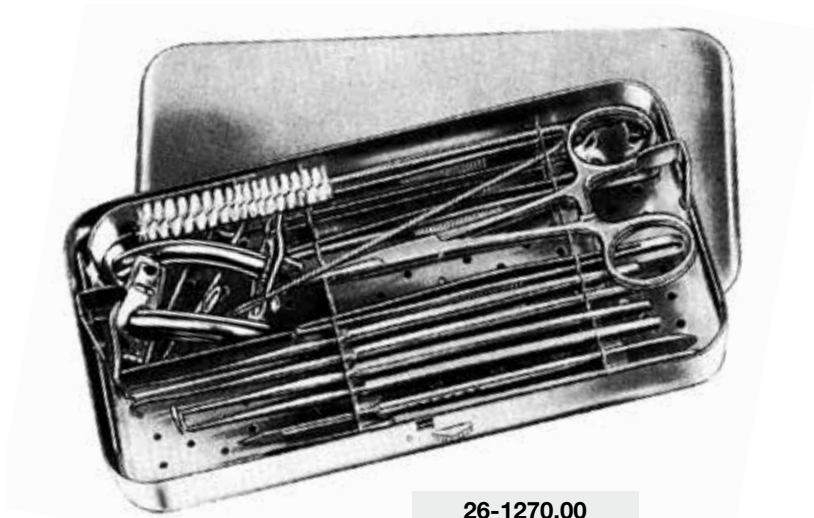

26-1270.00

Tracheotomiebesteck, komplett
Tracheotomy set, complete
Jeu d'instruments pour trachéotomie, complet
Juego para traqueotomía, completo

Kropf • Goitre • Goitre • Bocio



KOCHER



26-1301.15
15 cm, 5 3/4"



26-1303.16
16 cm, 6 1/4"



SCHOENBORN

26-1311.21
21 cm, 8 1/4"



LAHEY

26-1320.15 15 cm, 5 3/4"
26-1320.20 20 cm, 8"



MASTIN

26-1327.17
17 cm, 6 3/4"



Rippenscheren
Rib Shears
Costotomes
Costótomos

27



27-1402.23
23 cm, 9"



27-1405.22
22 cm, 8 1/2"



GLUCK
27-1407.22
22 cm, 8 1/2"



STILLE
27-1411.21
21 cm, 8 1/4"

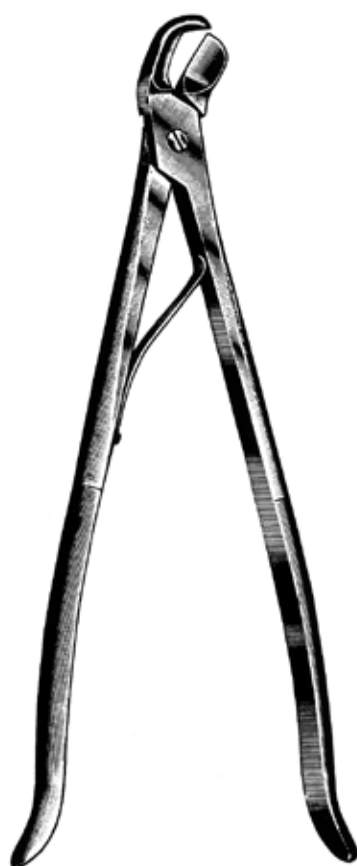

CORYLLOS
27-1423.35
35 cm, 13 3/4"

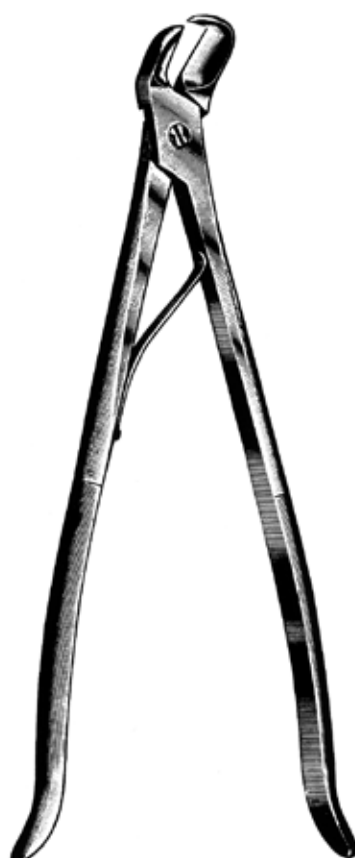

CORYLLOS
27-1425.35
35 cm, 13 3/4"



BETHUNE
27-1426.34
34 cm, 13 1/4"

Rippenscheren
Rib Shears
Costotomes
Costótomos



SAUERBRUCH

27-1431.26

26 cm, 10 1/4"



GIERTZ-STILLE

27-1437.27

27 cm, 10 1/2"



SAUERBRUCH-FREI

27-1441.36

36 cm, 14"

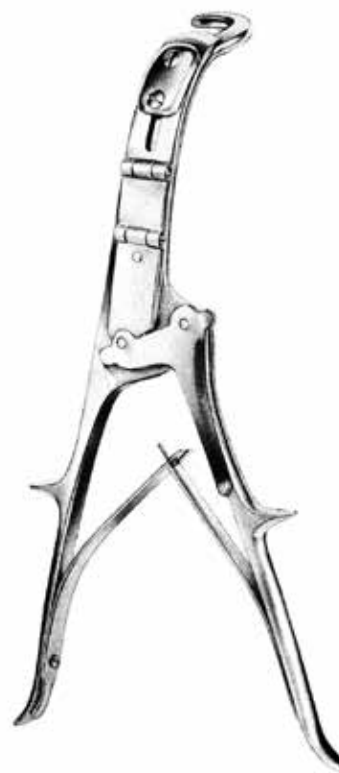

BRUNNER

27-1447.28

28 cm, 11"

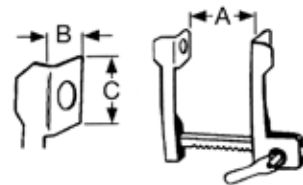

FINOCHIETTO	A	B	C
27-1510.16	165 mm	40 mm	40 mm
27-1510.20	200 mm	45 mm	55 mm
27-1510.25	250 mm	70 mm	65 mm

27



ALUMINIUM

FINOCHIETTO	A	B	C
27-1513.13	135 mm	38 mm	44 mm
27-1513.17	175 mm	52 mm	62 mm
27-1513.18	175 mm	85 mm	65 mm

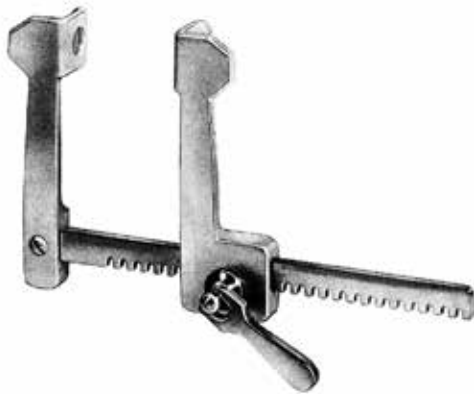
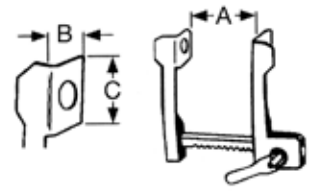

FINOCHIETTO-BABY	A	B	C
27-1514.75	75 mm	18 mm	20 mm

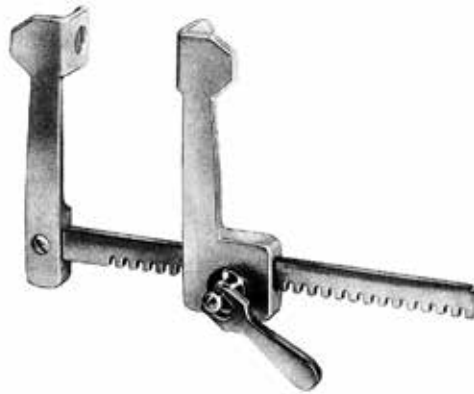

ALUMINIUM

FINOCHIETTO-BABY	A	B	C
27-1534.75	75 mm	15 mm	15 mm

70 x 65 mm

45 x 65 mm

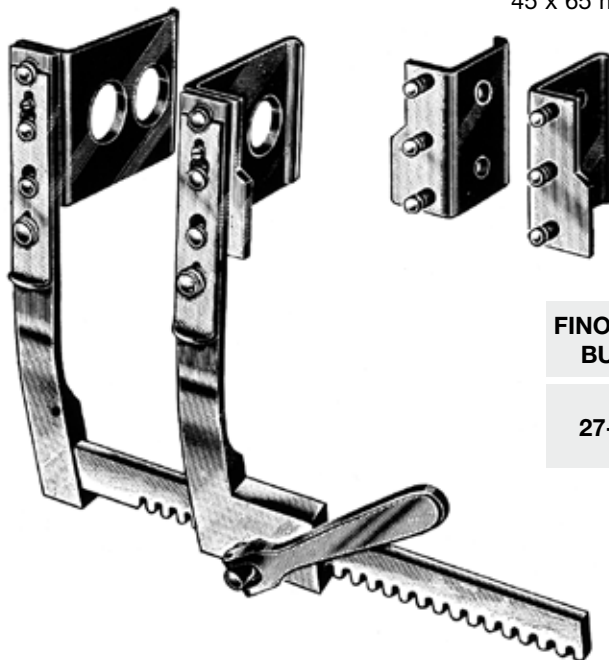

FINOCHIETTO-BURFORD	A	B	C
27-1536.25	250 mm	45 mm	65 mm
		70 mm	65 mm

Rippensperrer
Rib Spreaders
Ecarteurs des cotes
Separadores costales

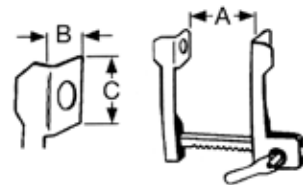

47 x 62 mm

65 x 62 mm

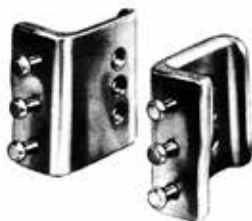
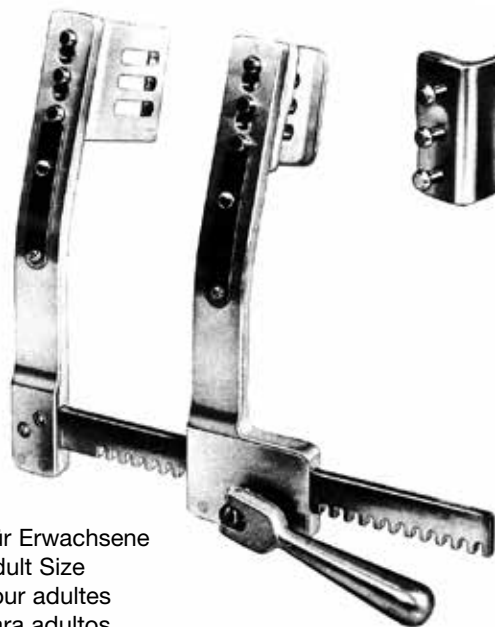

ALUMINIUM

FINOCHIETTO-BURFORD	A
27-1542.18	180 mm
27-1542.26	260 mm
27-1542.30	300 mm

B	C
47 mm	62 mm
65 mm	62 mm

Für Erwachsene
 Adult Size
 pour adultes
 para adultos

34 x 42 mm

48 x 42 mm



ALUMINIUM

FINOCHIETTO-BURFORD	A	B	C
27-1544.13	135 mm	34 mm	42 mm
		48 mm	42 mm

Für Kinder
 Child Size
 pour enfants
 para niños

27

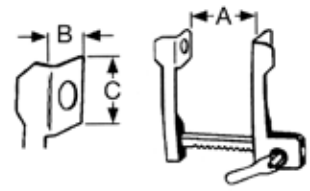

ALUMINIUM

CASTANEDA	A	B	C
27-1550.06	65 mm	10,5 mm	32 mm
27-1550.07	70 mm	12 mm	45 mm
27-1550.12	120 mm	15 mm	60 mm

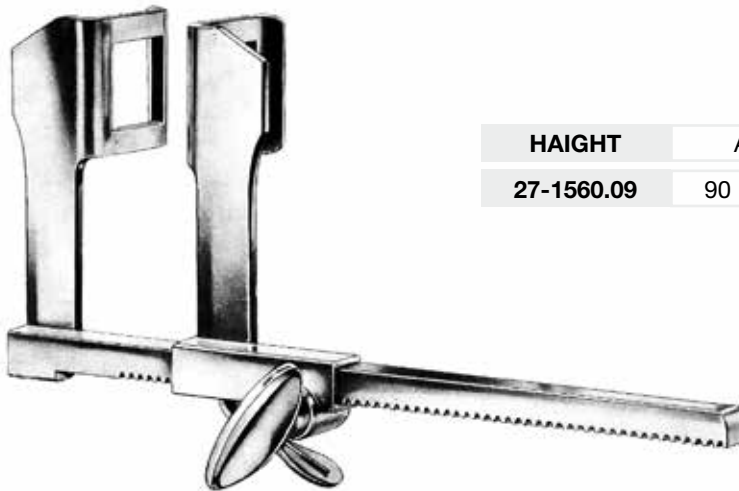

HAIGHT	A	B	C
27-1560.09	90 mm	30 mm	30 mm



TUFFIER	A	B	C
27-1564.16	165 mm	50 mm	45 mm

Rippensperrer
Rib Spreaders
Ecarteurs des cotes
Separadores costales

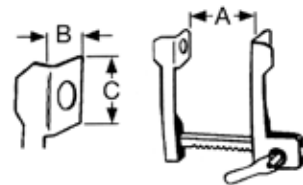

75 x 75 mm (B x C)



42 x 65 mm (B x C)

MERCEDES

27-1570.00



SELLORS

27-1580.19

19 cm, 7 1/2"



BAILEY-BABY

27-1582.14

14 cm, 5 1/2"



BAILEY

27-1584.16

16 cm, 6 1/4"

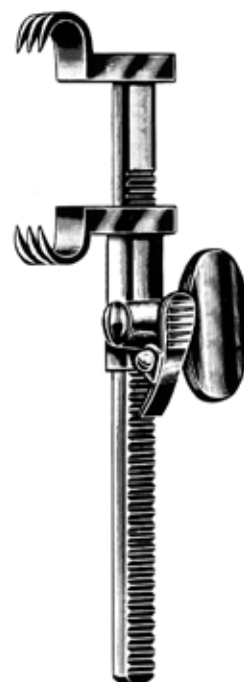

BAILEY-GIBBON

27-1586.16

16 cm, 6 1/4"

27

Lungenspatel, Lungenfaßzangen
Lung Spatula, Lung Grasping Forceps
Spatules pulmonaires, Pincès à saisir le poumon
Espátulas pulmonares, Pinzas para coger el pulmón



ALLISON

27-1689.32

32 cm, 12 3/4"



LOVELACE

27-1690.20

20 cm, 8"



LOVELACE

27-1691.20

20 cm, 8"

Bronchusklemmen
Bronchus Forceps
Pinces clamps pour les bronches
Pinzas clamps bronquiales



HARRINGTON

27-1701.30

30,5 cm, 12 1/4"

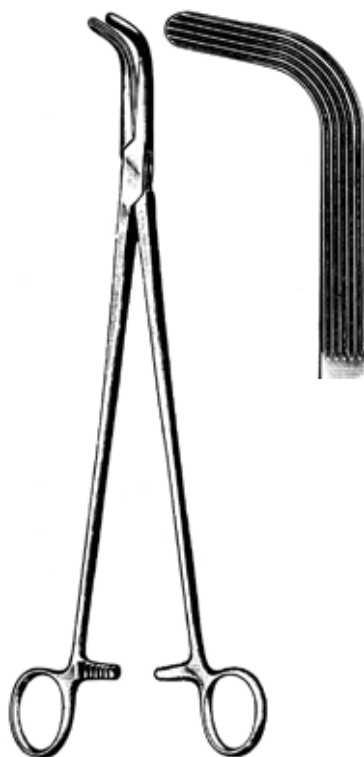

HARRINGTON

27-1703.29

29,5 cm, 11 1/2"

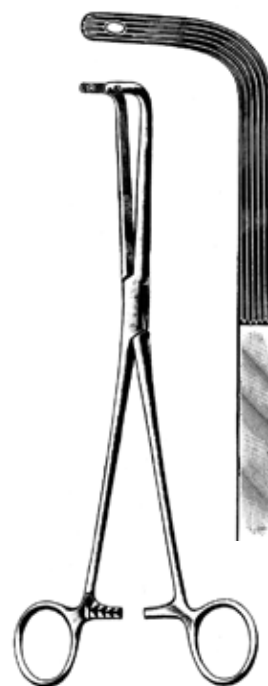

FINOCHIETTO

27-1707.24

24 cm, 9 1/2"



PRICE-THOMAS

27-1709.22

22 cm, 8 1/2"



PRICE-THOMAS

27-1711.22

22 cm, 8 1/2"



PRICE-THOMAS

27-1713.22

22 cm, 8 1/2"

27

Bronchusklemmen
Bronchus Forceps
Pinces clamps pour les bronches
Pinzas clamps bronquiales



SAROT



27-1717.23
23 cm, 9"



27-1719.23
23 cm, 9"



SEMB



27-1721.23
23 cm, 9"



27-1723.23
23 cm, 9"



SATINSKY
27-1725.15
15 cm, 5 3/4"

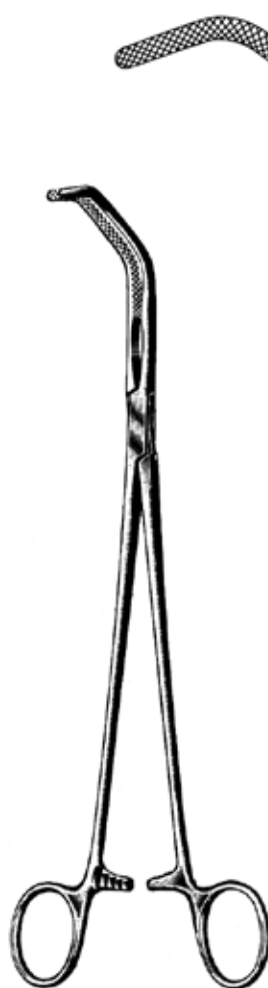

SATINSKY
26 cm, 10 1/4"

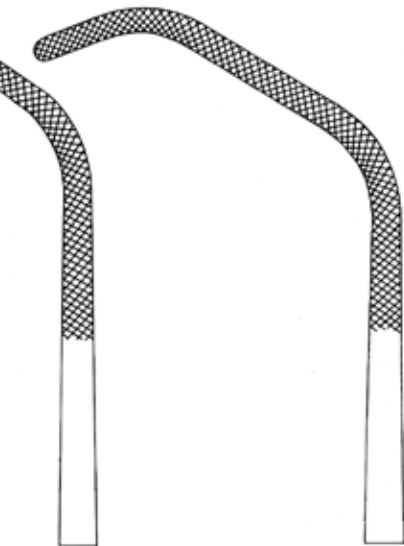

27-1727.26
Fig. 1

27-1729.26
Fig. 2

Galle, Niere
Gall Bladder, Kidney
Voies billiaires, Rein
Vesícula biliar, Riñon





DESJARDINS

23 cm, 9"



28-1001.23

Fig. 1



28-1003.23

Fig. 2



BLAKE

28-1006.20

20 cm, 8"



BLAKE

28-1007.20

20 cm, 8"



MAYO-BLAKE

28-1010.20

20 cm, 8"



MAYO-BLAKE

28-1011.20

20 cm, 8"



MIXTER

28-1017.22

22 cm, 8 1/2"

Galle
Gall Bladder
Voies billiaires
Vesícula biliar



MOORE

28-1025.28

28 cm, 11"



FERGUSSON

28-1070.21

21,5 cm, 8 1/4"

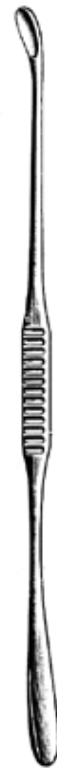

MAYO

28-1075.27

27 cm, 10 1/2"



MAYO



28-1078.01

27 cm, 10 1/2"



28-1078.02

27 cm, 10 1/2"



DESJARDINGS



28-1080.17

Charr. 17



28-1080.21

Charr. 21



28-1080.24

Charr. 24



28-1080.27

Charr. 27



DESJARDINGS

28 cm, 11"



28-1030.13

Charr. 13



28-1030.18

Charr. 18



28-1030.21

Charr. 21



OCHSNER

28-1028.35

35 cm, 13 3/4"



MOYNIHAN

28-1042.34

34 cm, 13 1/4"

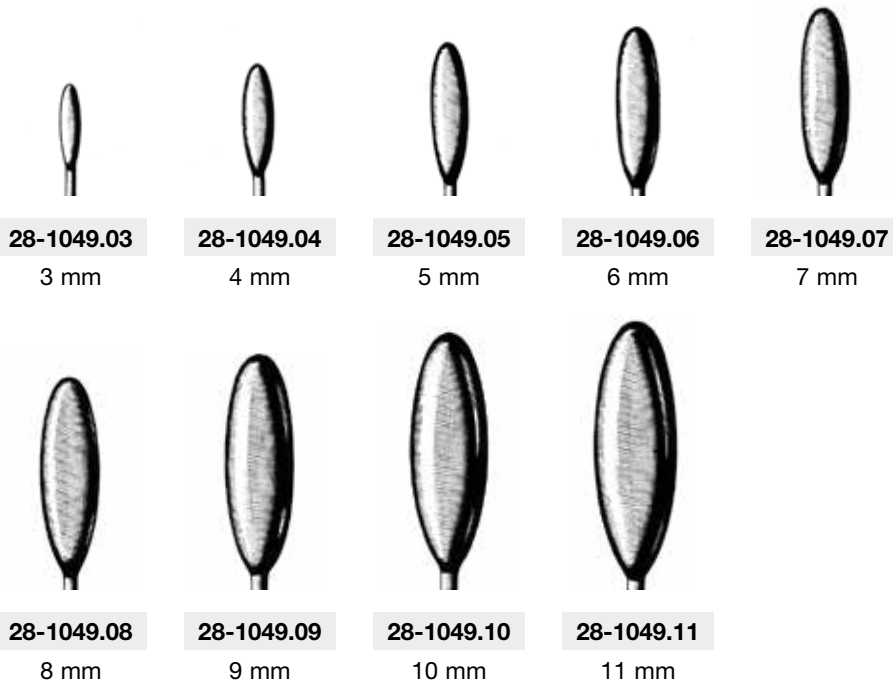

BAKES

28-1049.00

21 cm, 8 1/4"

Satz von 9 Dilatationsoliven (28-1049.03 - 28-1049.11)
Set of 9 dilators (28-1049.03 - 28-1049.11)
Jeu de 9 dilatateurs (28-1049.03 - 28-1049.11)
Juego de 9 dilatadores (28-1049.03 - 28-1049.11)

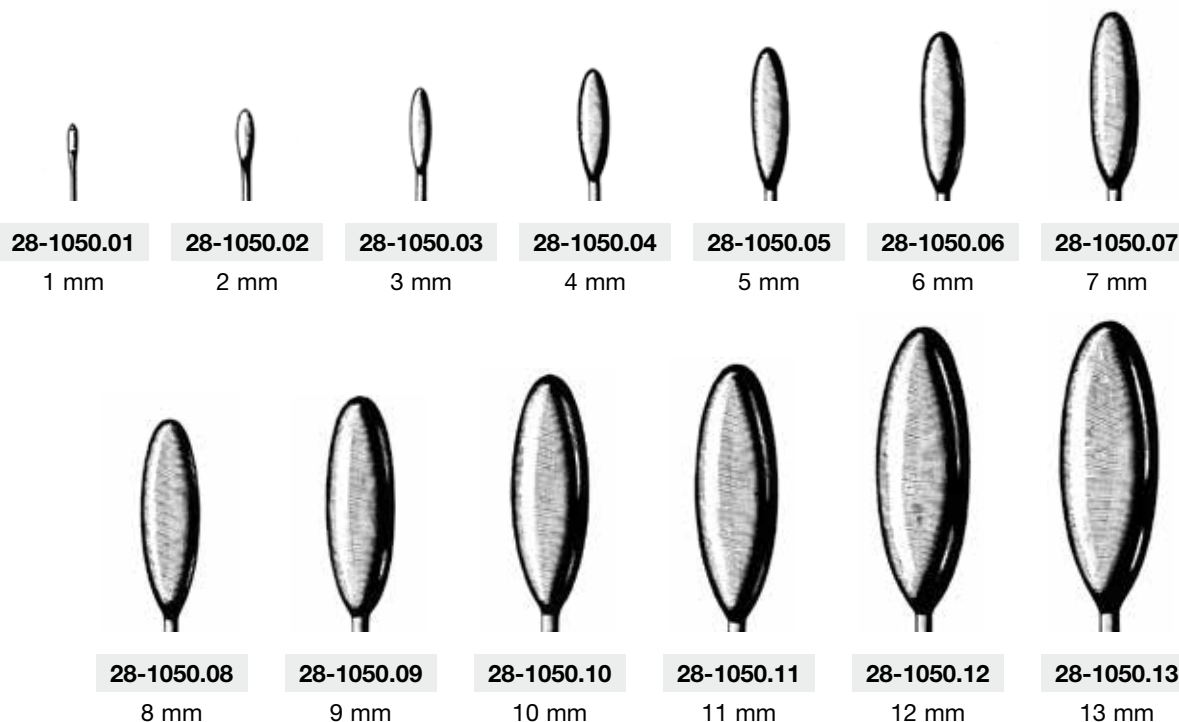

BAKES

28-1050.00

30 cm, 12"

Satz von 13 Dilatationsoliven (28-1049.01 - 28-1049.13)
Set of 13 dilators (28-1049.01 - 28-1049.13)
Jeu de 13 dilatateurs (28-1049.01 - 28-1049.13)
Juego de 13 dilatadores (28-1049.01 - 28-1049.13)

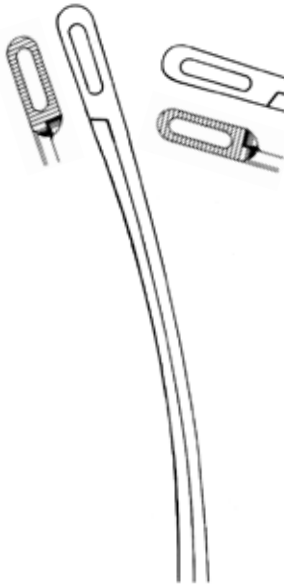

28-1131.01

Fig. 1

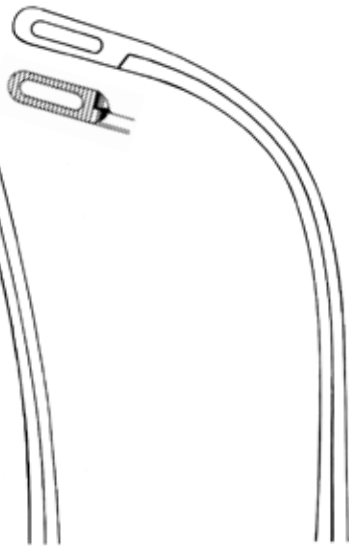

28-1131.02

Fig. 2

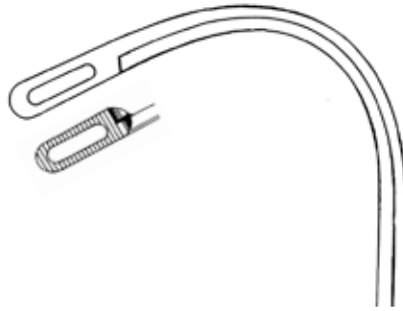

28-1131.03

Fig. 3

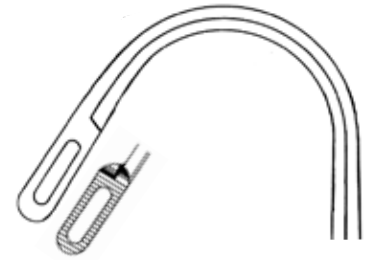

28-1131.04

Fig. 4

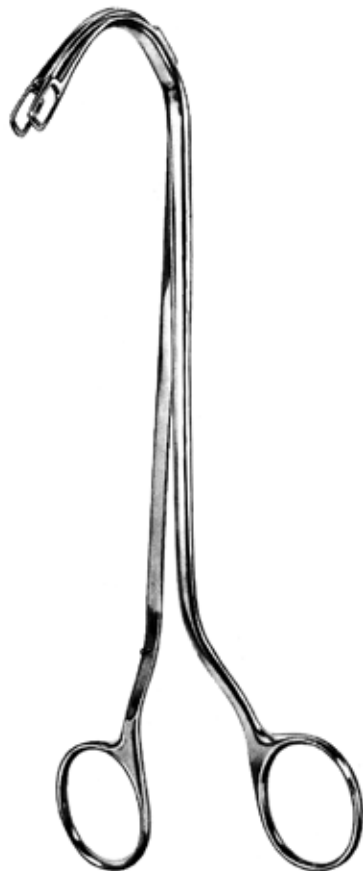

RANDALL

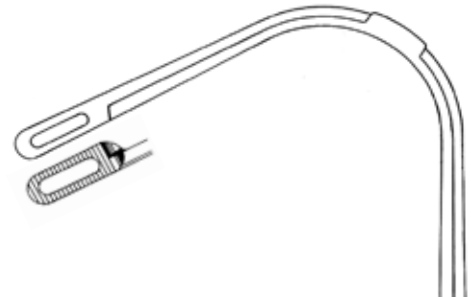

28-1131.05

Fig. 5

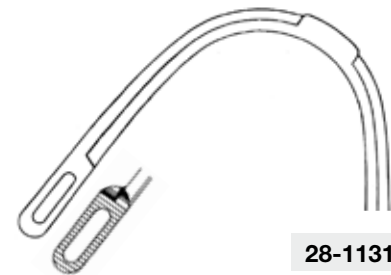

28-1131.06

Fig. 6



MAYO

28-1110.32

32 cm, 12 3/4"



LURZ

28-1121.21

21 cm, 8 1/4"



LURZ

28-1123.21

21 cm, 8 1/4"

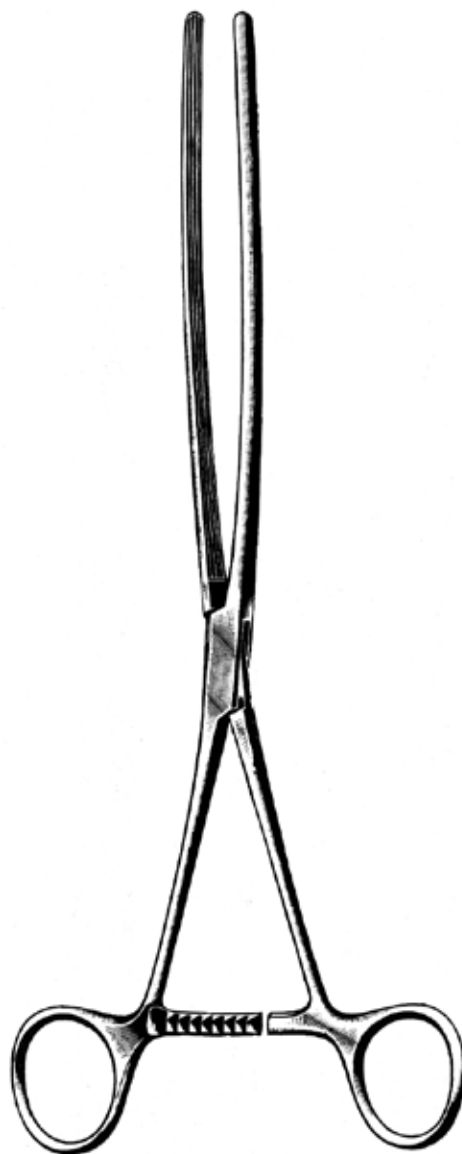

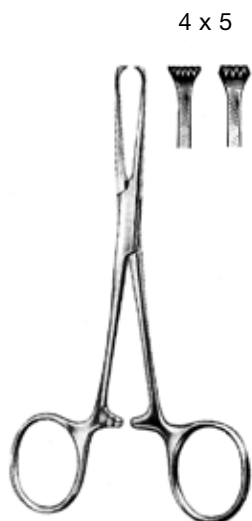

4 x 5

ALLIS-BABY

29-1002.14

14 cm, 5 1/2"



4 x 5

ALLIS

29-1010.15

15 cm, 5 3/4"



ALLIS-ADAIR

29-1030.15

15,5 cm, 5 3/4"



THOMS-ALLIS

29-1040.20

20 cm, 8"



5 x 6

ALLIS

29-1020.15 15 cm, 5 3/4"

29-1020.19 19 cm, 7 1/2"

29-1020.22 22 cm, 8 1/2"

29-1020.24 24 cm, 9 1/2"



atraumatisch
 atraumatic
 atraumatique
 atraumática

ALLIS

29-1024.16 16 cm, 6 1/4"

29-1024.20 20 cm, 8"

29-1024.25 25 cm, 10"



JUDD-ALLIS

29-1040.15 15 cm, 5 3/4"

29-1040.19 19 cm, 7 1/2"

Darm, Magen
Intestines and Stomach
Intestin et estomac
Intestinos y estómago



BABCOCK

29-1060.16	16 cm, 6 1/4"
29-1060.18	18 cm, 7"
29-1060.20	20 cm, 8"
29-1060.24	24 cm, 9 1/2"



Hartmetall Einlagen
 Tungsten Carbide Inserts

BABCOCK

29-1064.16	16 cm, 6 1/4"
29-1064.20	20 cm, 8"

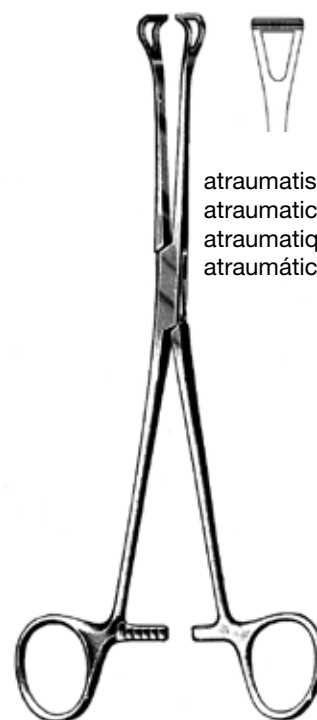

atraumatisch
 atraumatic
 atraumatique
 atraumática

BABCOCK

29-1068.16	16 cm, 6 1/4"
29-1068.20	20 cm, 8"

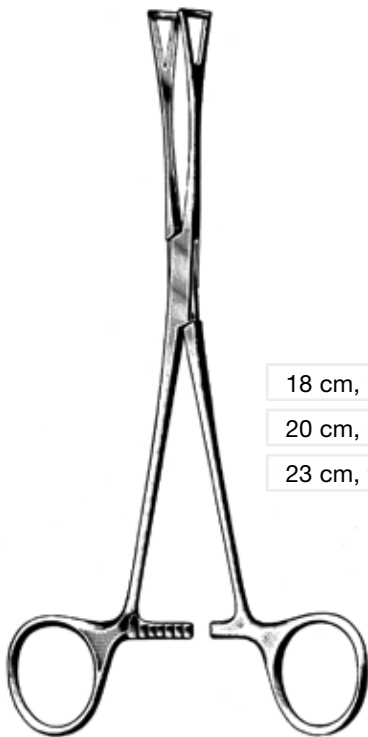

DUVAL

18 cm, 7"	29-1070.18	
20 cm, 8"	29-1070.20	29-1072.20
23 cm, 9"		29-1072.23

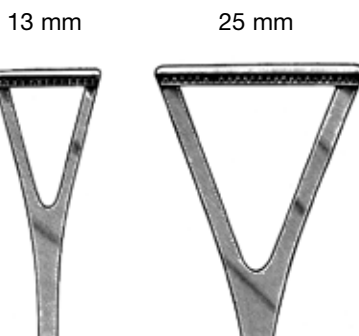

13 mm

25 mm

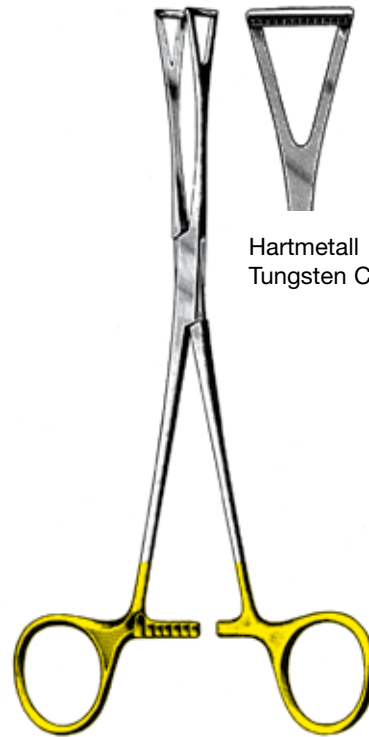

Hartmetall
 Tungsten Carbide

DUVAL

29-1074.20	20 cm, 8"
-------------------	-----------



WILLIAMS

29-1080.16

16,5 cm, 6 1/2"



SCHOENBURG

29-1082.22

22 cm, 8 1/2"

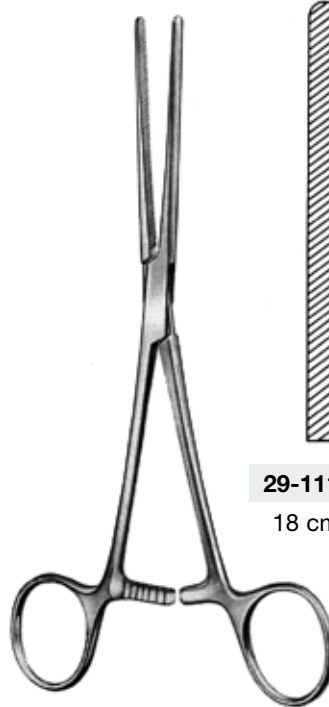

DOYEN-BABY

29-1110.18

18 cm, 7"



29-1111.18

18 cm, 7"



DOYEN

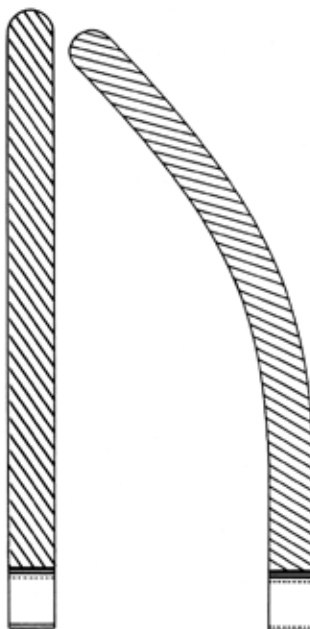

21 cm, 8 1/4"

29-1110.21

29-1111.21

23 cm, 9"

29-1110.23

29-1111.23

atraumatisch
 atraumatic
 atraumatique
 atraumática

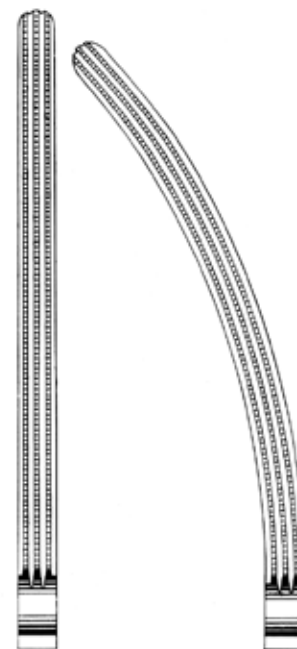

16 cm, 6 1/4"

29-1116.16

29-1117.16

18 cm, 7"

29-1116.18

29-1117.18

21 cm, 8 1/4"

29-1116.21

29-1117.21

23 cm, 9"

29-1116.23

29-1117.23

Darm, Magen
Intestines and Stomach
Intestin et estomac
Intestinos y estómago



KOCHER

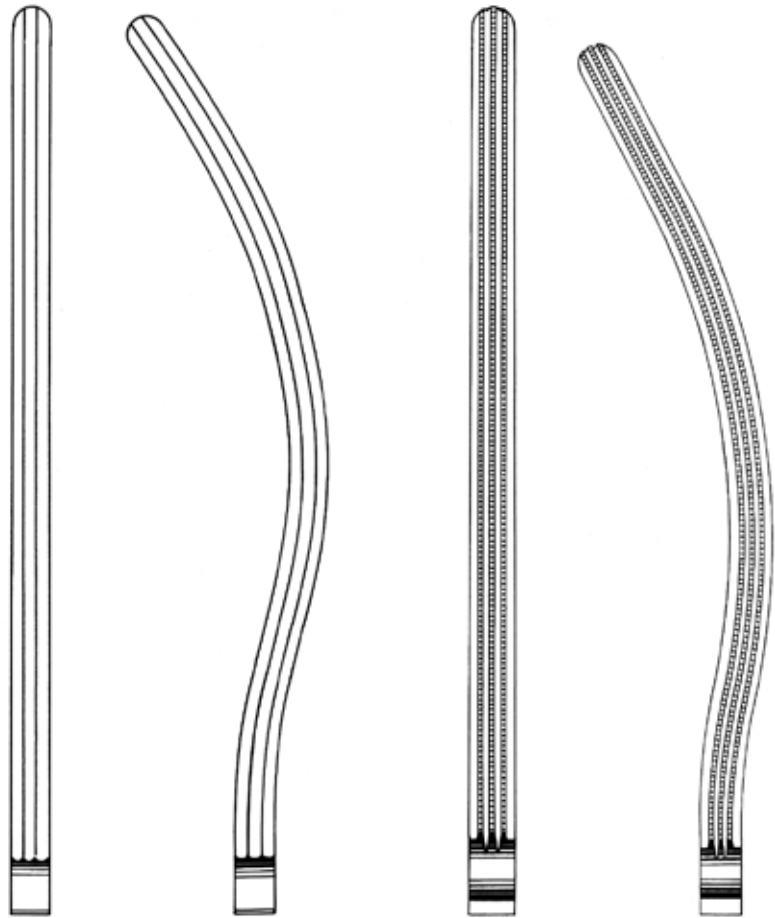

22 cm, 8 1/2"	29-1120.22	29-1121.22	29-1126.22	29-1127.22
25 cm, 10"	29-1120.25	29-1121.25	29-1126.25	29-1127.25
28 cm, 11"	29-1120.28	29-1121.28	29-1126.28	29-1127.28

atraumatisch
 atraumatic
 atraumatique
 atraumática

atraumatisch
 atraumatic
 atraumatique
 atraumática

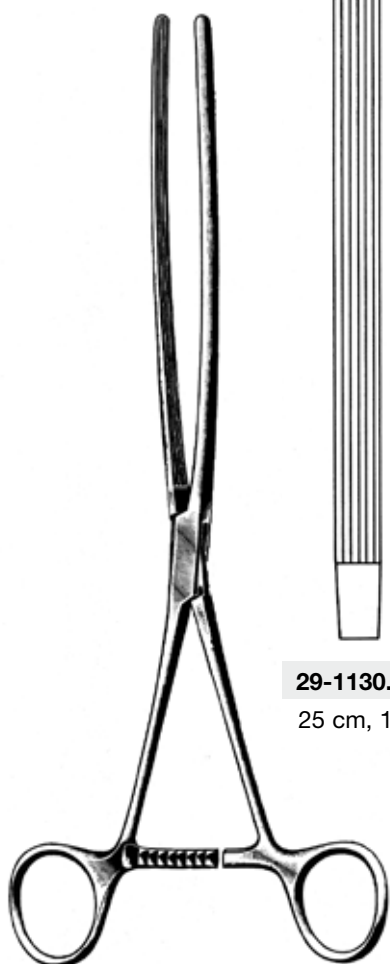

MAYO-ROBSON



29-1130.25
 25 cm, 10"

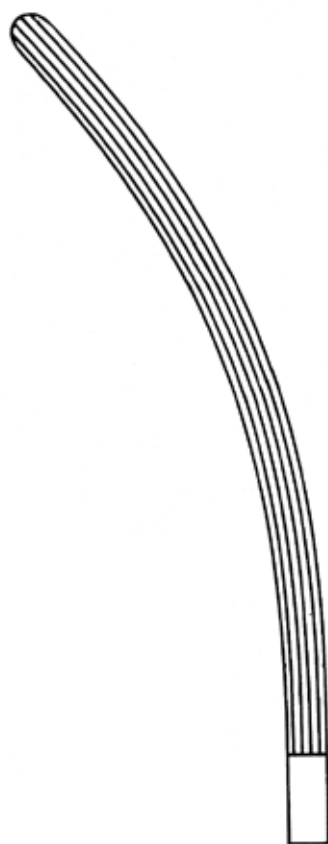

29-1131.25
 25 cm, 10"



29-1136.25
 25 cm, 10"

atraumatisch
 atraumatic
 atraumatique
 atraumática

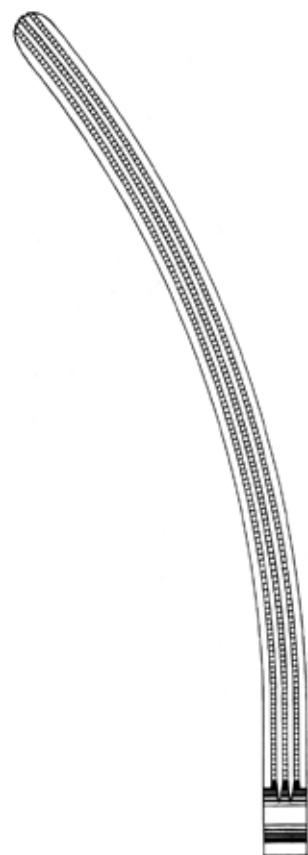

29-1137.25
 25 cm, 10"

atraumatisch
 atraumatic
 atraumatique
 atraumática

Darm, Magen
Intestines and Stomach
Intestin et estomac
Intestinos y estómago



FEHLAND

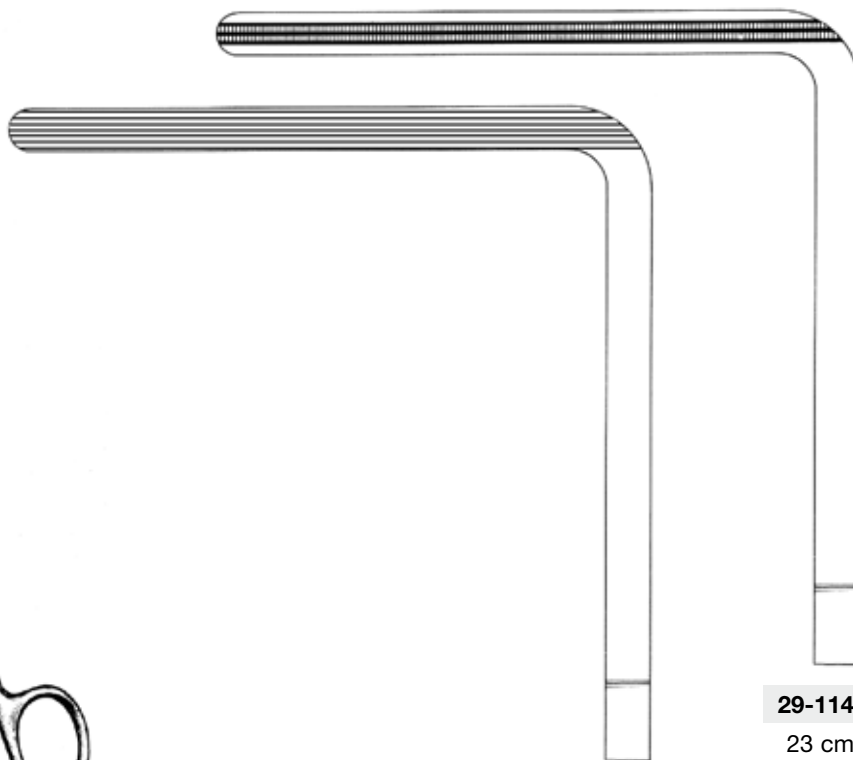

29-1141.23

23 cm, 9"

29-1147.23

23 cm, 9"

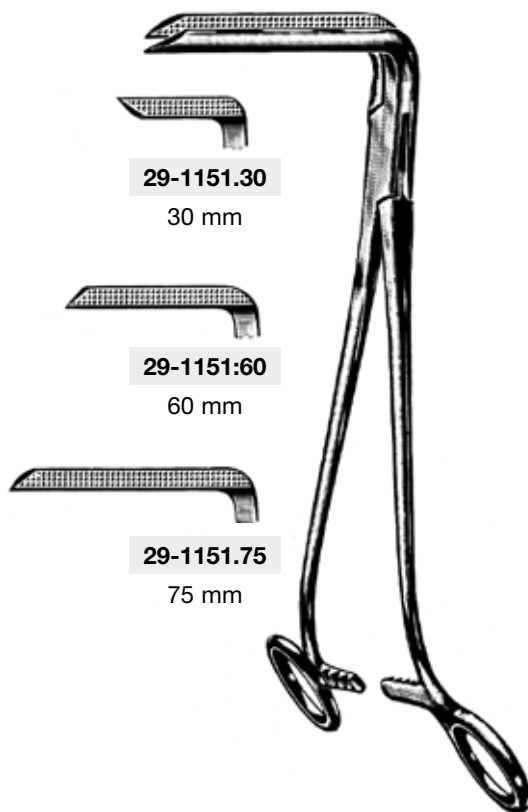

29-1151.30

30 mm

29-1151:60

60 mm

29-1151.75

75 mm

BEST

26,5 cm, 10 1/2"



BRUNNER

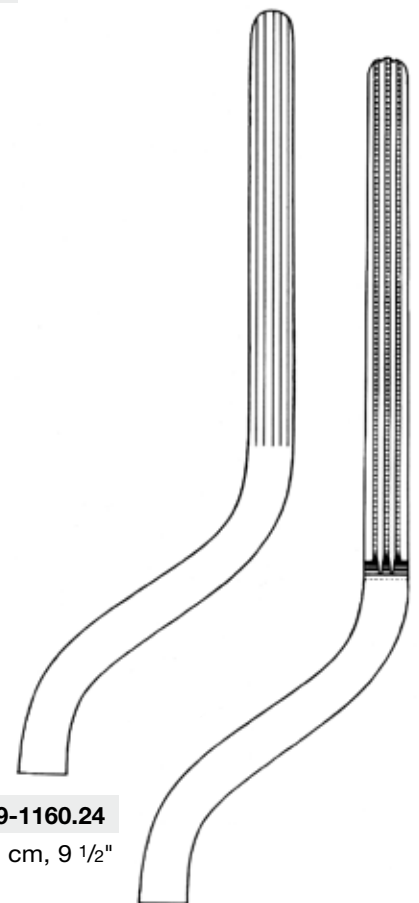

29-1160.24

24 cm, 9 1/2"

29-1166.24

24 cm, 9 1/2"



STONE

29-1170.15

15,5 cm, 6"



STONE-WATT

29-1172.07 7,5 cm, 3"

29-1172.10 10 cm, 4"



STONE-WATT

29-1174.00



DE MARTEL-WOLFSON

29-1180.05 5 cm, 2"

29-1180.07 7 cm, 2 2/4"

29-1180.10 10 cm, 4"



DE MARTEL-WOLFSON

29-1182.26

26 cm, 10 1/4"



DE MARTEL-WOLFSON

29-1184.08

8,5 cm, 3 1/2"

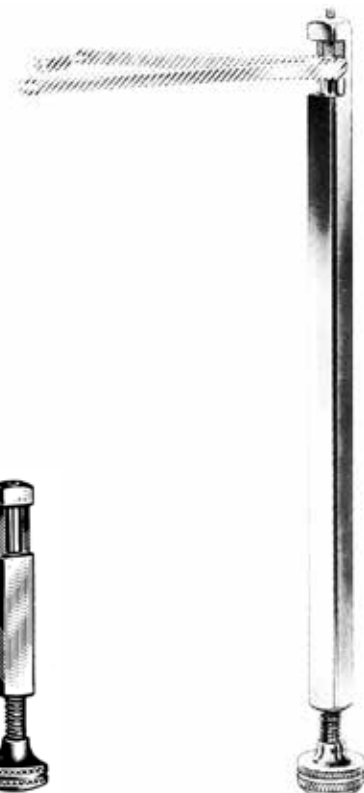

DE MARTEL-WOLFSON

29-1184.23

23 cm, 9"

Darm, Magen
Intestines and Stomach
Intestin et estomac
Intestinos y estómago

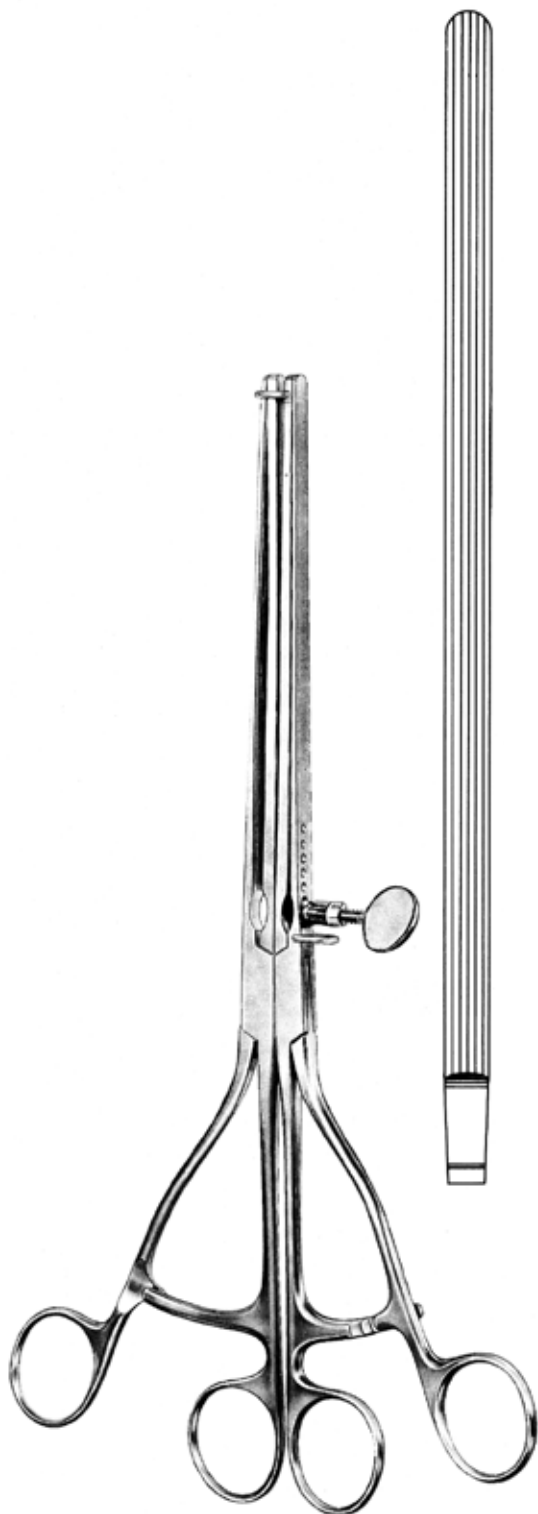

LANE

29-1190.30

30 cm, 12"



LANE

29-1191.30

30 cm, 12"

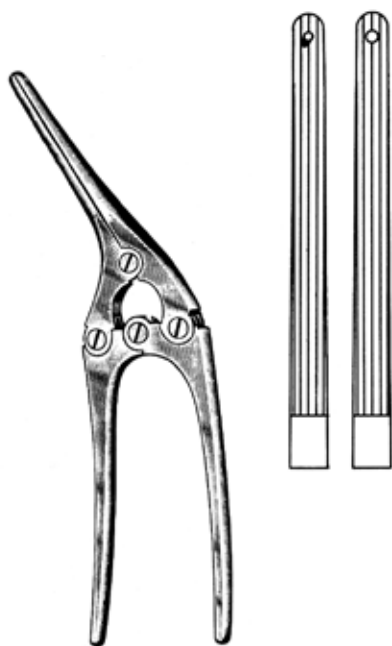

PAYR-BABY

29-1210.15

15 cm, 5 3/4"



PAYR

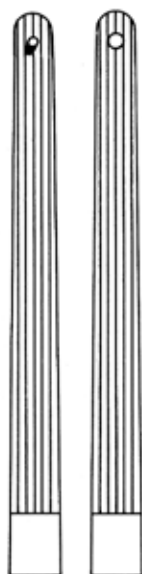

29-1210.21

21 cm, 8 1/4"

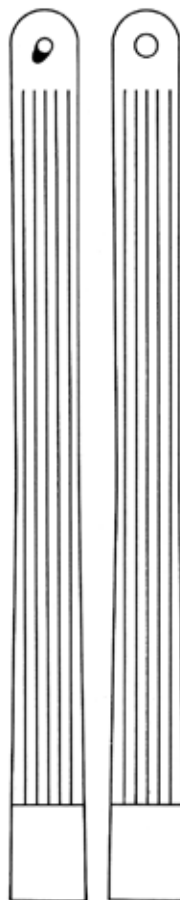

29-1210.29

29 cm, 11 1/4"

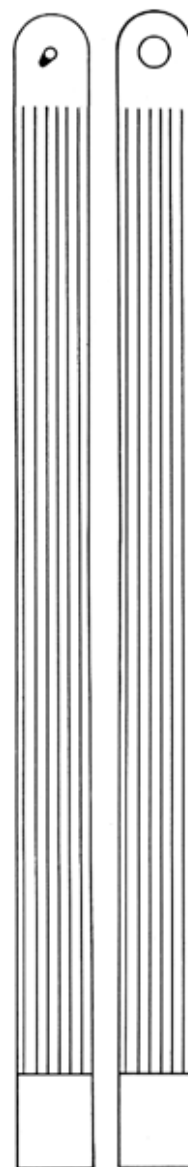

29-1210.35

35 cm, 13 3/4"

Magen- und Darmnähhapparat
Stomach and Intestinal Suturing Apparatus
Appareil à sutures stomacales et intestinales
Aparato para suturas estomacales e intestinales

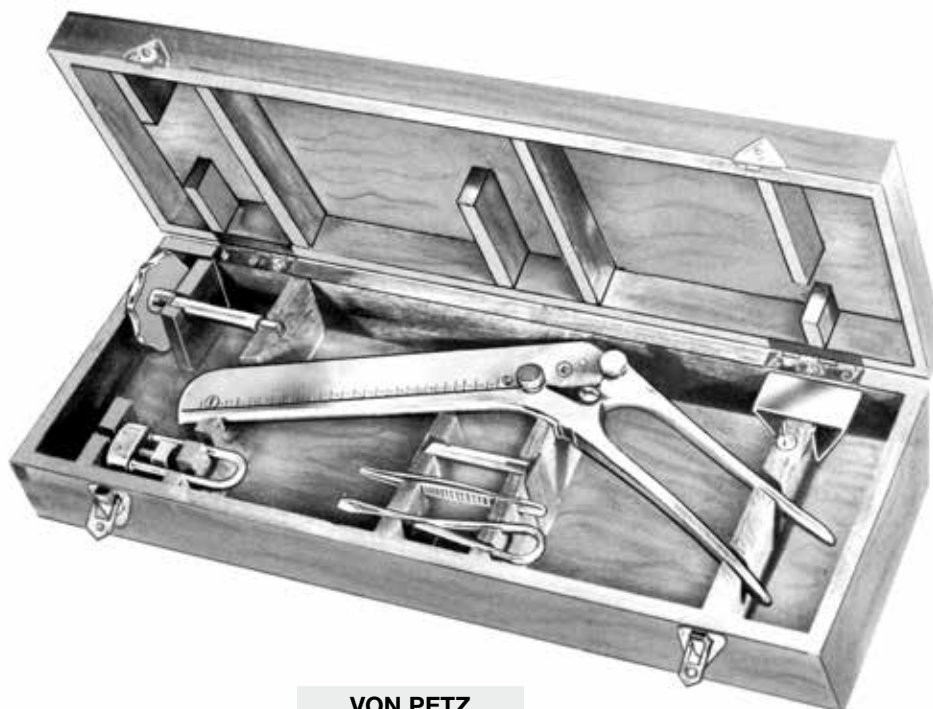

VON PETZ

29-1220.00

compl.



300 Stück
300 ea.
300 pièces
300 c/u

29-1221.00



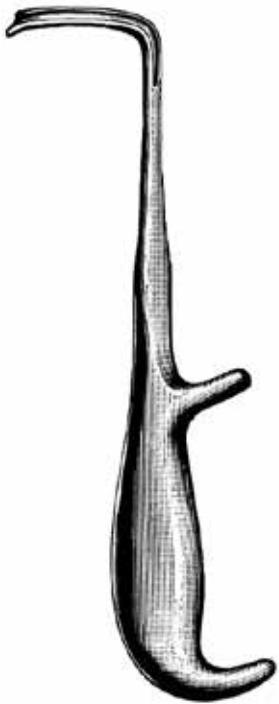

YOUNG
30-1301.21
21 cm, 8 1/4"

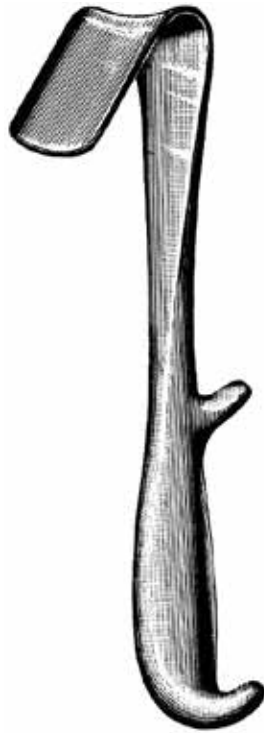

YOUNG
30-1303.21
22 cm, 8 1/2"



YOUNG
30-1305.21
21 cm, 8 1/4"

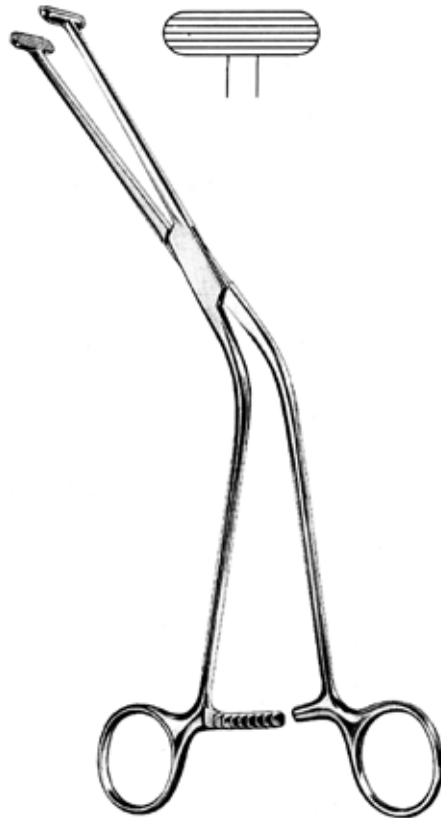

MILLIN
30-1311.23
23 cm, 9"

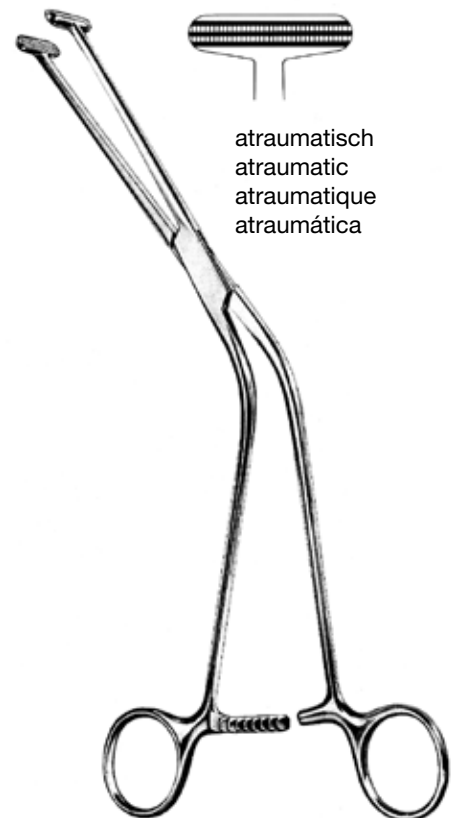

MILLIN
30-1313.23
23 cm, 9"

atraumatisch
atraumatic
atraumatique
atraumática

YOUNG
30-1306.20
20 cm, 8"

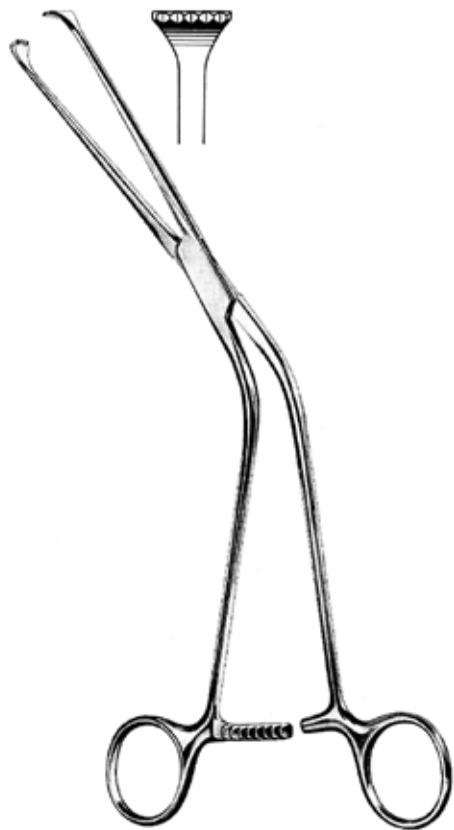

MILLIN

30-1323.23

23 cm, 9"

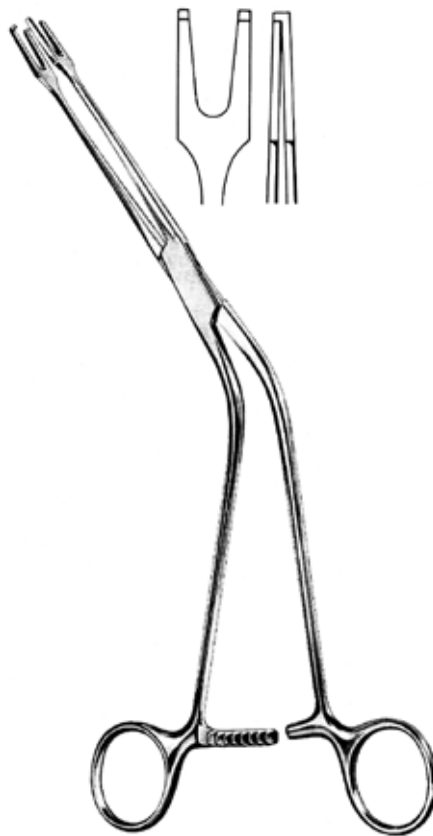

MILLIN

30-1325.24

24 cm, 9 1/2"



MILLIN

30-1365.00



JUDD-MASSON

30-1350.00



LEGUEU

30-1363.00



THOMSON-WALKER
30-1360.00



LEGUEU
30-1347.27
27 cm, 10 1/2"



KOCHER
30-1349.27
27 cm, 10 1/2"

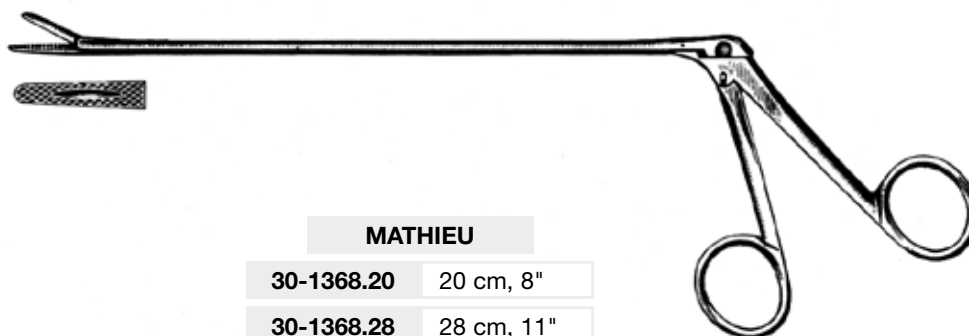

MATHIEU

30-1368.20 20 cm, 8"

30-1368.28 28 cm, 11"

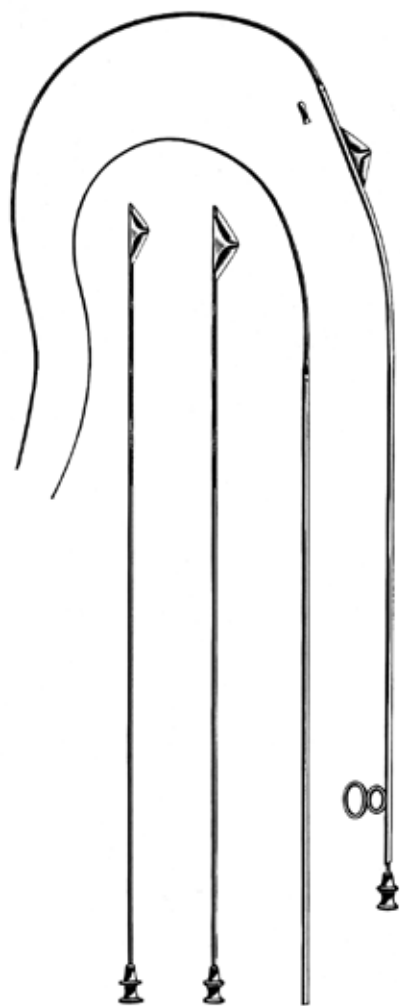

MAISONNEUVE

30-1370.00

komplett mit Holzetui (30-1370.01)
complete with wooden case (30-1370.01)
complet avec boîte bois (30-1370.01)
completo con estuche de madera (30-1370.01)



STOCKMANN

30-1475.08

8 cm, 3 1/4"



STRAUSS

30-1477.11

11 cm, 4 1/4"



GUTMANN

30-1480.26

26 cm, 10 1/4"



GUYON

30-1484.39

39 cm, 15 1/2"

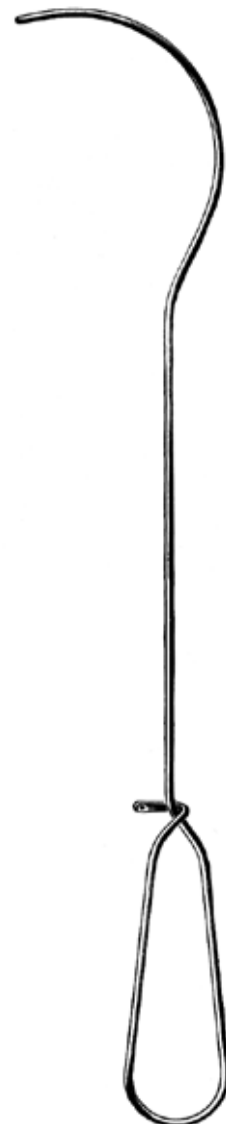

GUYON

30-1485.35

35 cm, 13 3/4"



GUYON

30-1500.00

Harnröhren-Dilatationsbesteck
Urethral Dilation Set
Jeu d'instruments pour la dilatation de l'urètre
Juego de instrumentos para la dilatación de la uretra



VAN BUREN

30-1501.08	Charr. 8
30-1501.10	Charr. 10
30-1501.12	Charr. 12
30-1501.14	Charr. 14
30-1501.16	Charr. 16
30-1501.18	Charr. 18
30-1501.20	Charr. 20
30-1501.22	Charr. 22
30-1501.24	Charr. 24
30-1501.26	Charr. 26
30-1501.28	Charr. 28
30-1501.30	Charr. 30
30-1501.32	Charr. 32
30-1501.34	Charr. 34
30-1501.36	Charr. 36



GUYON

30-1505.08	Charr. 8	30-1505.24	Charr. 24
30-1505.09	Charr. 9	30-1505.26	Charr. 26
30-1505.10	Charr. 10	30-1505.28	Charr. 28
30-1505.11	Charr. 11	30-1505.30	Charr. 30
30-1505.12	Charr. 12	30-1505.32	Charr. 32
30-1505.14	Charr. 14	30-1505.34	Charr. 34
30-1505.16	Charr. 16	30-1505.36	Charr. 36
30-1505.18	Charr. 18	30-1505.38	Charr. 38
30-1505.20	Charr. 20	30-1505.39	Charr. 39
30-1505.22	Charr. 22	30-1505.40	Charr. 40

30-1501.00

Set: 30-1501.00 - 30-1501-36



für Männer
male catheters
pour hommes
para hombres

30-1511.08	Charr. 8
30-1511.10	Charr. 10
30-1511.12	Charr. 12
30-1511.14	Charr. 14
30-1511.16	Charr. 16
30-1511.18	Charr. 18
30-1511.20	Charr. 20
30-1511.22	Charr. 22
30-1511.24	Charr. 24



für Frauen
female catheters
pour femmes
para mujeres

30-1513.08	Charr. 8
30-1513.10	Charr. 10
30-1513.12	Charr. 12
30-1513.14	Charr. 14
30-1513.16	Charr. 16
30-1513.18	Charr. 18
30-1513.20	Charr. 20
30-1513.22	Charr. 22
30-1513.24	Charr. 24



für Frauen
female catheters
pour femmes
para mujeres

COXETER	
30-1519.08	Charr. 8
30-1519.10	Charr. 10
30-1519.12	Charr. 12
30-1519.14	Charr. 14
30-1519.16	Charr. 16
30-1519.18	Charr. 18
30-1519.20	Charr. 20
30-1519.22	Charr. 22
30-1519.24	Charr. 24

Mastdarm
Rectum
Rectum
Recto





SIMS

31-1110.15

15 cm, 5 3/4"



BODENHAMMER

31-1115.15

15 cm, 5 3/4"

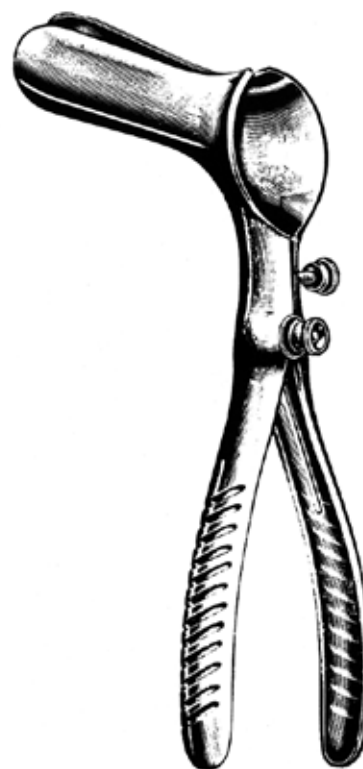

PRATT

31-1121.22

22 cm, 8 1/2"



BARR

31-1125.17

17 cm, 6 3/4"



MATHIEU

31-1130.19

19,5 cm, 7 3/4"



CZERNY

31-1105.22

22 cm, 8 1/2"



ALLAN-PARKS

31-1147.00

13,5 cm, 5 1/4"

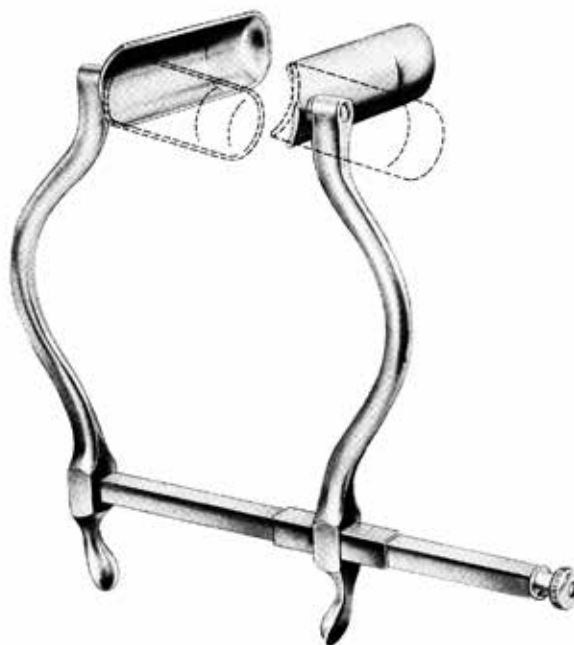

SMITH-BUIE

31-1150.15

15 cm, 5 3/4"



STRAUSS

31-1160.00

komplett mit Holzetui
complete with wooden case
complet avec boîte bois
completo con estuche de madera

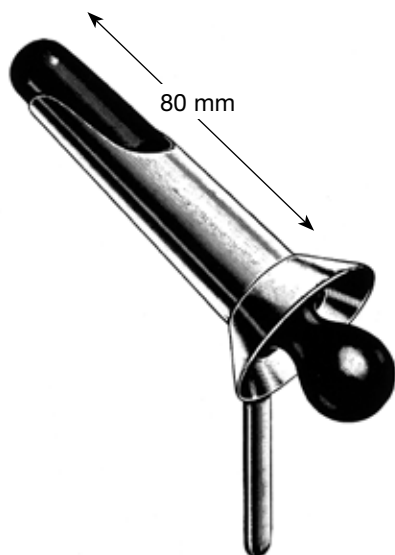

IVES-FANSLER

31-1210.22

Ø 22 mm



HIRSCHMANN

31-1212.16 16 mm

31-1212.19 19 mm

31-1212.22 22 mm



KELLY

31-1224.21 21 x 50 mm

31-1224.27 27 x 50 mm



KELLY

31-1220.05 22 x 50 mm

31-1220.10 22 x 100 mm

31-1220.14 22 x 140 mm

31-1220.20 22 x 200 mm



PRATT

Cystikus-Haken
Cystic Hooks
Ecarteurs rectaux
Ganchos rectales

31-1251.01

Fig. 1



31-1251.02

Fig. 2



31-1251.03

Fig. 3

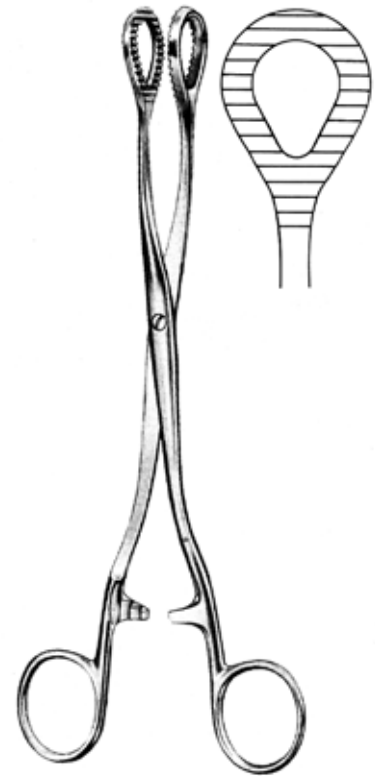

HEYWOOD-SMITH

31-1402.21

21 cm, 8 1/4"



BUIE

31-1261.41

41 cm, 16 1/2"

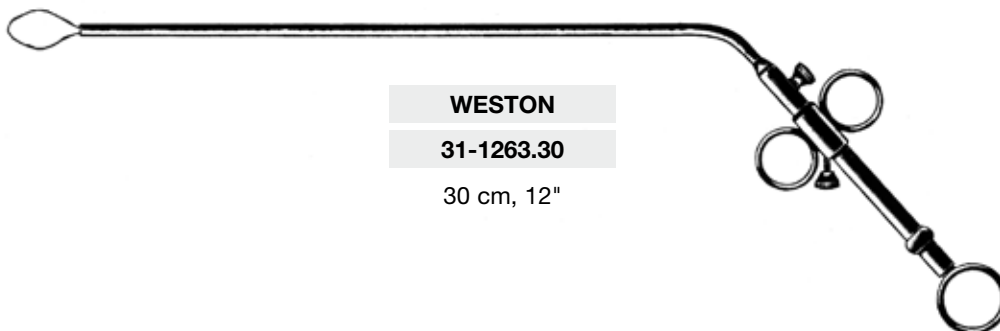

WESTON

31-1263.30

30 cm, 12"

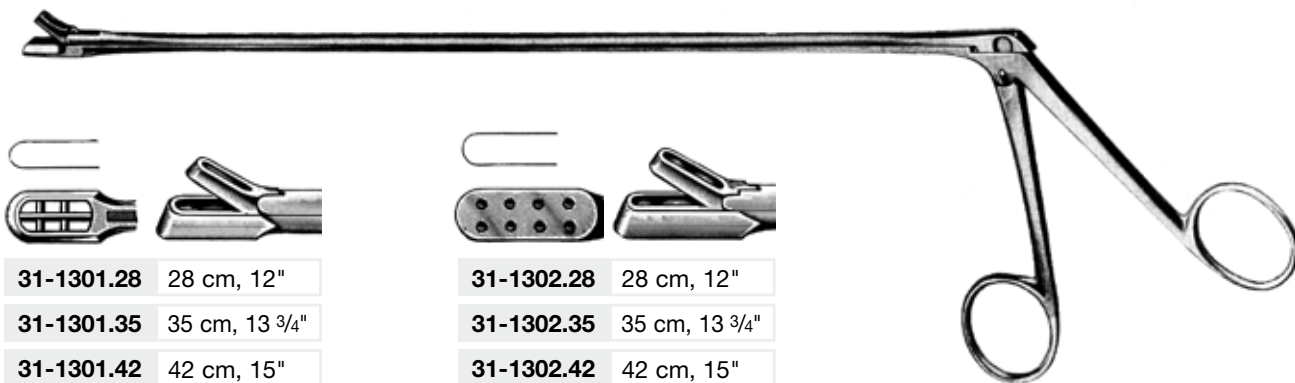

31-1301.28	28 cm, 12"
31-1301.35	35 cm, 13 3/4"
31-1301.42	42 cm, 15"



31-1302.28	28 cm, 12"
31-1302.35	35 cm, 13 3/4"
31-1302.42	42 cm, 15"

YEOMAN



31-1303.28	28 cm, 12"
31-1303.35	35 cm, 13 3/4"
31-1303.42	42 cm, 15"



31-1304.28	28 cm, 12"
31-1304.35	35 cm, 13 3/4"
31-1304.42	42 cm, 15"

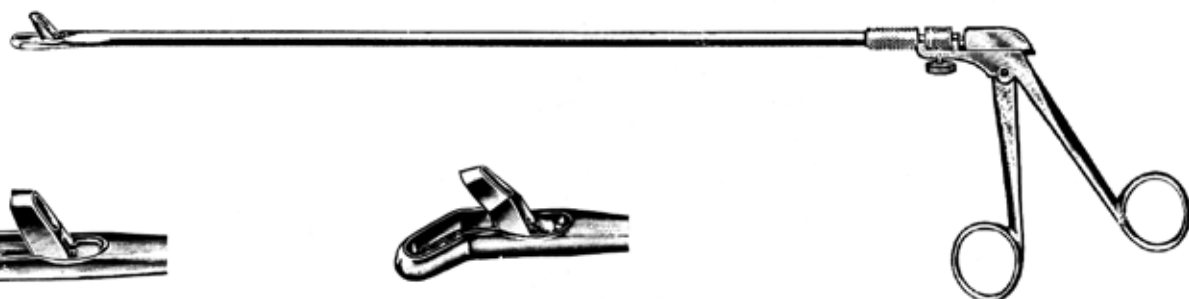

31-1311.23	23 cm, 9"
31-1311.33	33 cm, 13"
31-1311.40	40 cm, 16"



31-1321.23	23 cm, 9"
31-1321.33	33 cm, 13"
31-1321.40	40 cm, 16"

TURREL

drehbar
rotatable
rotative
giratoria

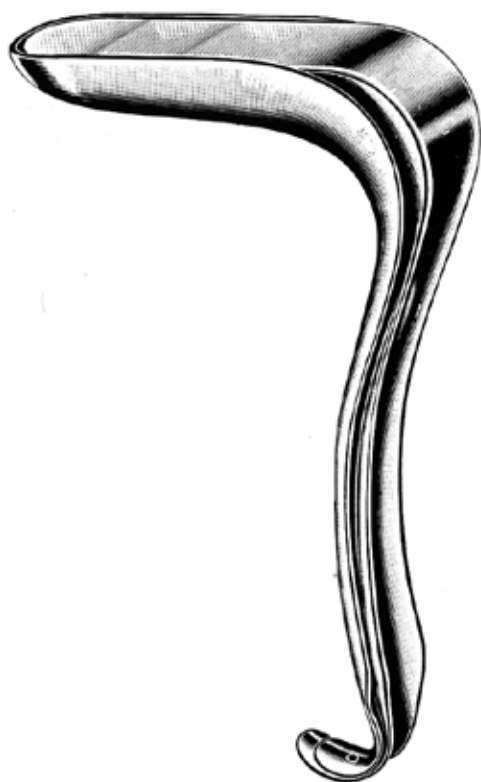



GRAVE

32-1010.01	Fig. 1	75 x 20 mm
32-1010.02	Fig. 2	95 x 35 mm
32-1010.03	Fig. 3	115 x 35 mm

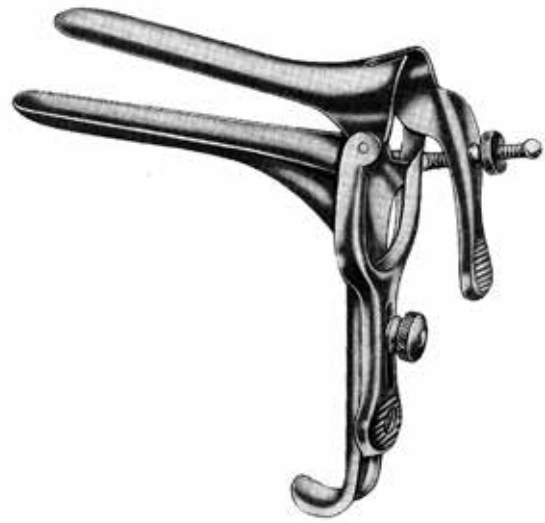

PEDDERSON

32-1020.01	Fig. 1	75 x 13 mm
32-1020.02	Fig. 2	100 x 22 mm
32-1020.03	Fig. 3	120 x 25 mm

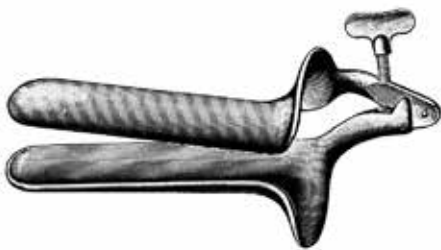

COLLIN

32-1030.01	Fig. 1	85 x 30 mm
32-1030.02	Fig. 2	100 x 35 mm
32-1030.03	Fig. 3	110 x 40 mm



COLLIN

32-1031.00

65 x 20 mm



COLLIN

32-1032.00

65 x 10 mm

Scheiden-Spekula
Vaginal Specula
Spéculums vaginaux
Espéculos vaginales



CUSCO		
32-1040.01	Fig. 1	75 x 32 mm
32-1040.02	Fig. 2	85 x 35 mm
32-1040.03	Fig. 3	100 x 35 mm



CUSCO		
32-1050.01	Fig. 1	75 x 32 mm
32-1050.02	Fig. 2	85 x 36 mm
32-1050.03	Fig. 3	95 x 37 mm



Schweizer Modell
 Swiss Pattern
 Modèle suisse
 Modelo suizo

CUSCO		
32-1060.01	Fig. 1	90 x 23-25 mm
32-1060.02	Fig. 2	100 x 25-27 mm
32-1060.03	Fig. 3	110 x 27-30 mm



CUSCO		
32-1042.00		75 x 17 mm

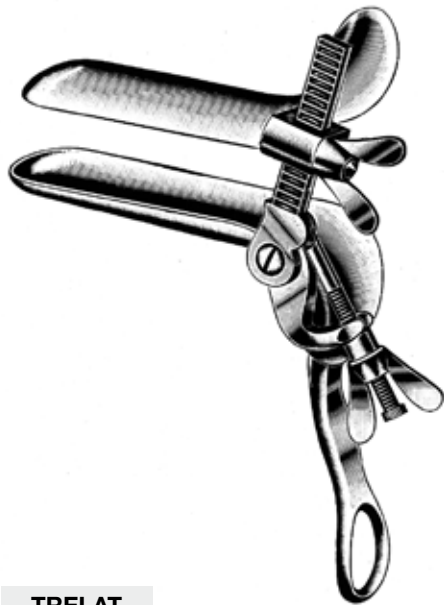

TRELAT

32-1080.01	Fig. 1	85 x 33 mm
32-1080.02	Fig. 2	95 x 35 mm
32-1080.03	Fig. 3	115 x 43 mm



SEMM

32-1090.01	100 x 17-20 mm
32-1090.02	100 x 25-30 mm



Satz
 Set
 Jeu
 Juego

KRISTELLER

32-1110.01	Fig. 1
32-1110.02	Fig. 2
32-1110.03	Fig. 3

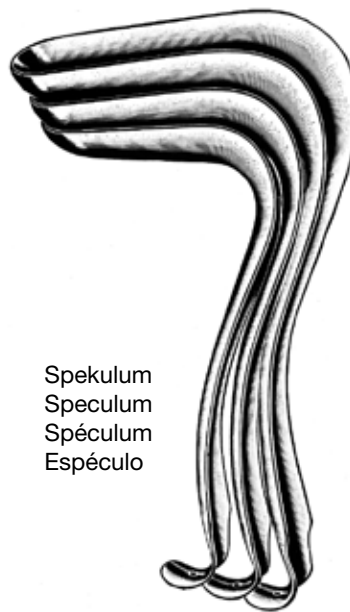

Spekulum
 Speculum
 Spéculum
 Espéculo

KRISTELLER

32-1111.01	Fig. 1
32-1111.02	Fig. 2
32-1111.03	Fig. 3

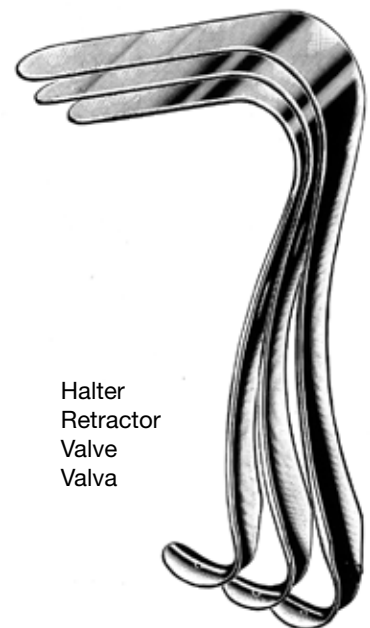

Halter
 Retractor
 Valve
 Valva

KRISTELLER

32-1112.01	Fig. 1
32-1112.02	Fig. 2
32-1112.03	Fig. 3

Scheiden-Spekula
Vaginal Specula
Spéculums vaginaux
Espéculos vaginales

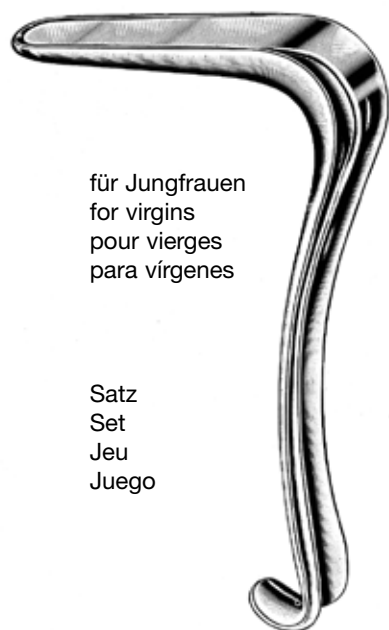

für Jungfrauen
 for virgins
 pour vierges
 para vírgenes

Satz
 Set
 Jeu
 Juego

KRISTELLER

32-1120.01 Fig. 1

32-1120.02 Fig. 2

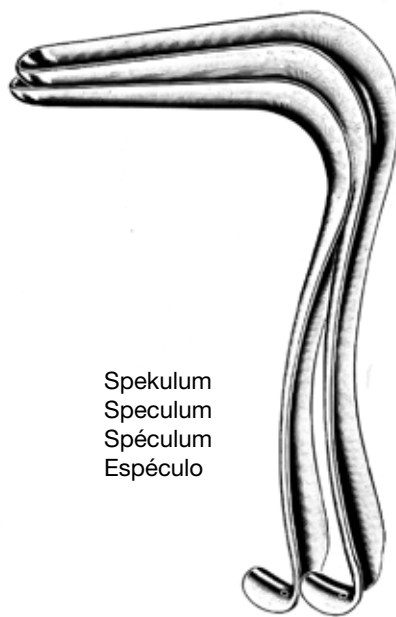

Spekulum
 Speculum
 Spéculum
 Espéculo

KRISTELLER

32-1121.01 Fig. 1

32-1121.02 Fig. 2

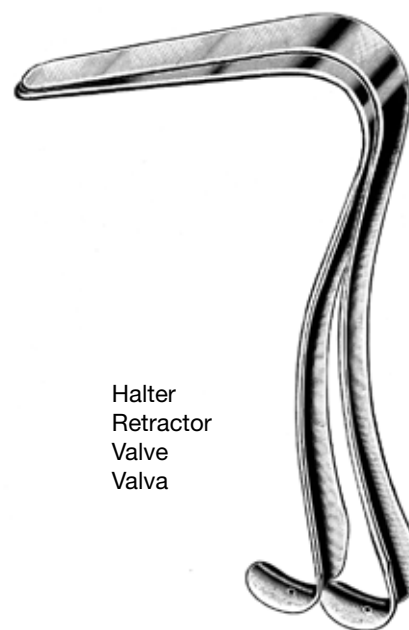

Halter
 Retractor
 Valve
 Valva

KRISTELLER

32-1122.01 Fig. 1

32-1122.02 Fig. 2



Satz
 Set
 Jeu
 Juego

KRISTELLER

32-1130.01 Fig. 1

32-1130.02 Fig. 2

32-1130.03 Fig. 3

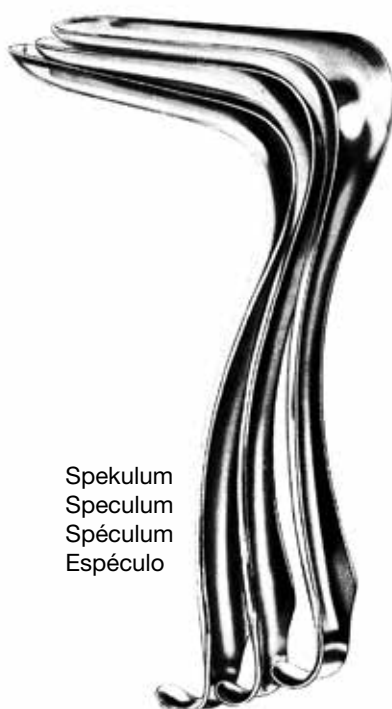

Spekulum
 Speculum
 Spéculum
 Espéculo

KRISTELLER

32-1131.01 Fig. 1

32-1131.02 Fig. 2

32-1131.03 Fig. 3

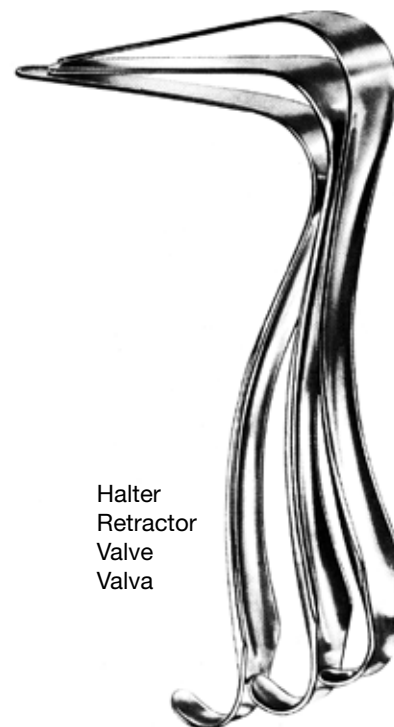

Halter
 Retractor
 Valve
 Valva

KRISTELLER

32-1132.01 Fig. 1

32-1132.02 Fig. 2

32-1132.03 Fig. 3

Scheiden-Spekula
 Vaginal Specula
 Spéculum vaginaux
 Espéculos vaginales

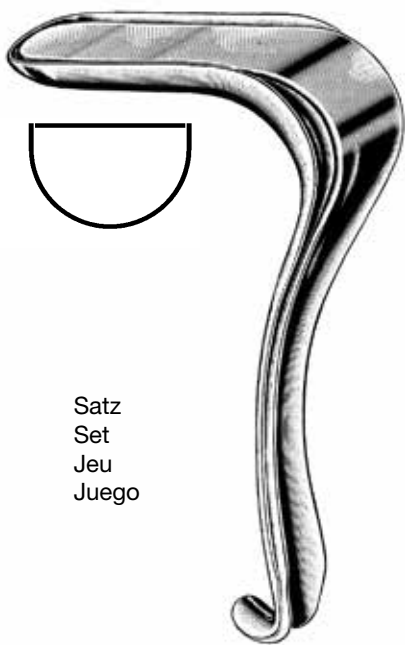

Satz
 Set
 Jeu
 Juego

KRISTELLER

32-1140.01 Fig. 1

32-1140.02 Fig. 2

32-1140.03 Fig. 3

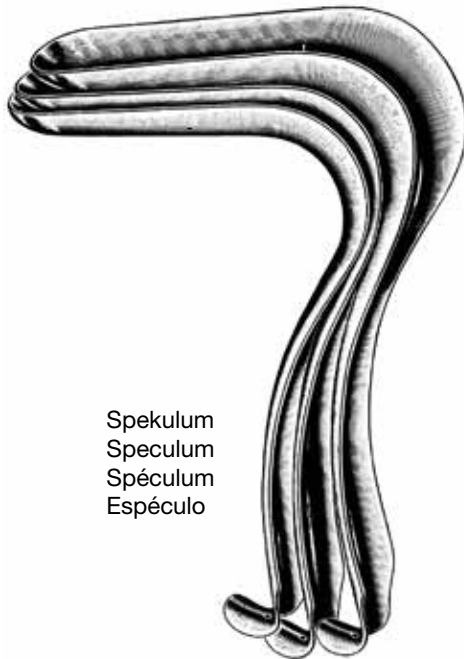

Spekulum
 Speculum
 Spéculum
 Espéculo

KRISTELLER

32-1141.01 Fig. 1

32-1141.02 Fig. 2

32-1141.03 Fig. 3

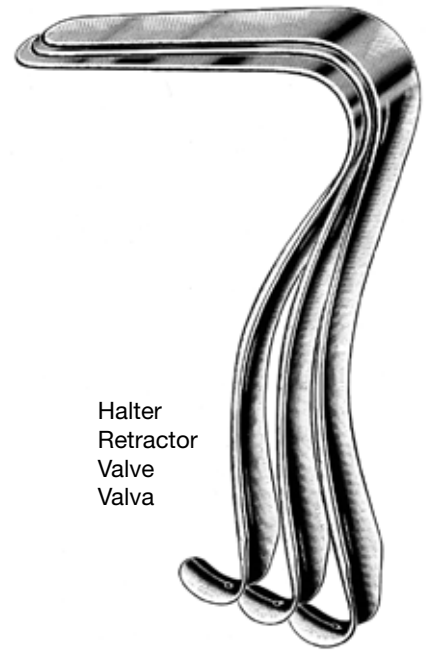

Halter
 Retractor
 Valve
 Valva

KRISTELLER

32-1142.01 Fig. 1

32-1142.02 Fig. 2

32-1142.03 Fig. 3

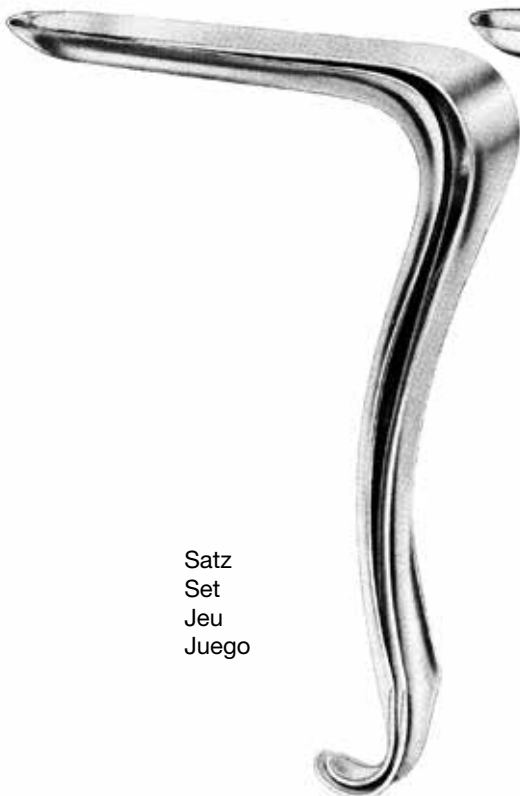

Satz
 Set
 Jeu
 Juego

KRISTELLER

32-1150.00

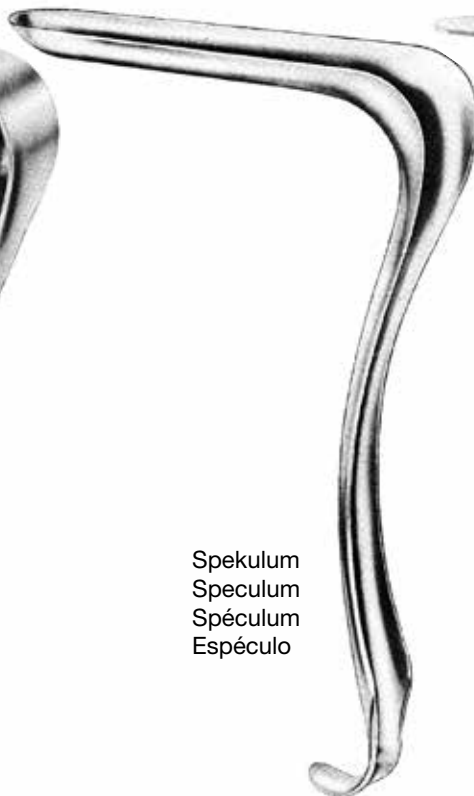

Spekulum
 Speculum
 Spéculum
 Espéculo

KRISTELLER

32-1151.00

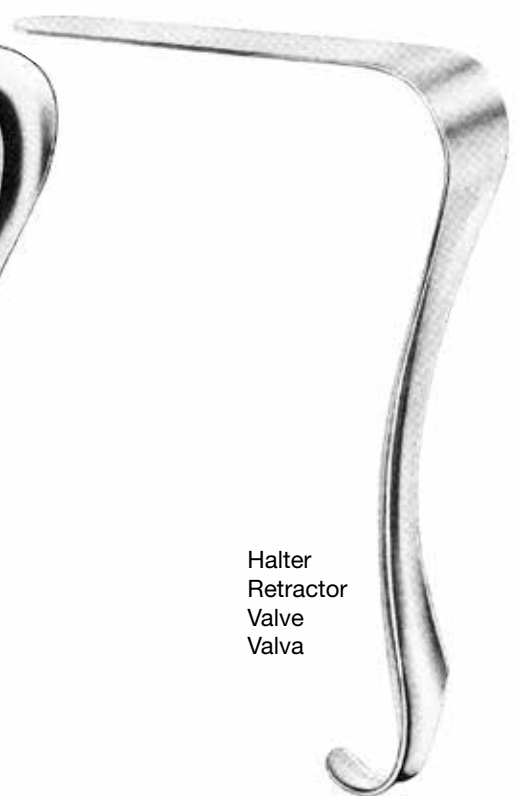

Halter
 Retractor
 Valve
 Valva

KRISTELLER

32-1152.00

Scheiden-Spekula
Vaginal Specula
Spéculums vaginaux
Espéculos vaginales



Satz
 Set
 Jeu
 Juego

KALLMORGEN

32-1160.01 Fig. 1

32-1160.02 Fig. 2

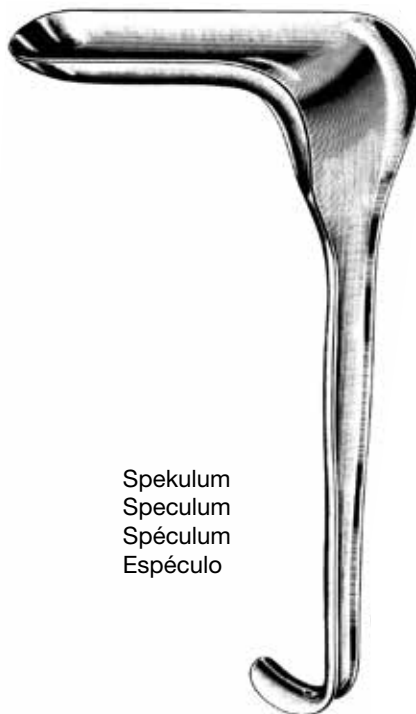

Spekulum
 Speculum
 Spéculum
 Espéculo

KALLMORGEN

32-1161.01 Fig. 1

32-1161.02 Fig. 2

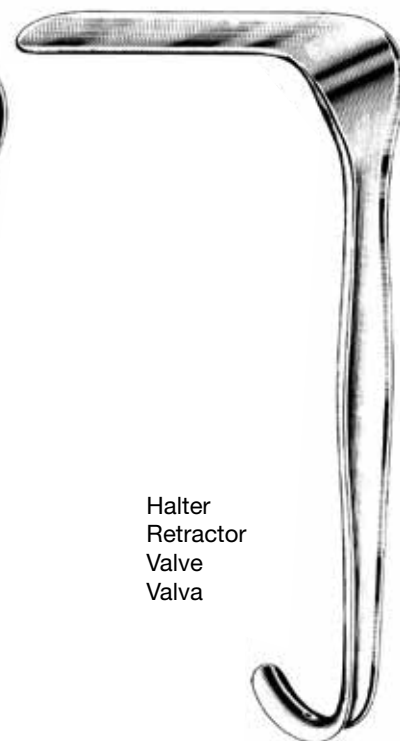

Halter
 Retractor
 Valve
 Valva

KALLMORGEN

32-1162.01 Fig. 1

32-1162.02 Fig. 2



JACKSON

32-1171.01 Fig. 1 75 x 38 mm

32-1171.02 Fig. 2 90 x 38 mm

32-1171.03 Fig. 3 100 x 38 mm



SIMS

32-1181.01 Fig. 1

32-1181.02 Fig. 2

32-1181.03 Fig. 3



SIMS

32-1191.00 Set

32-1191.01 Fig. 1

32-1191.02 Fig. 2

32-1191.03 Fig. 3

Scheiden-Spekula
 Vaginal Specula
 Spéculums vaginaux
 Espéculos vaginales

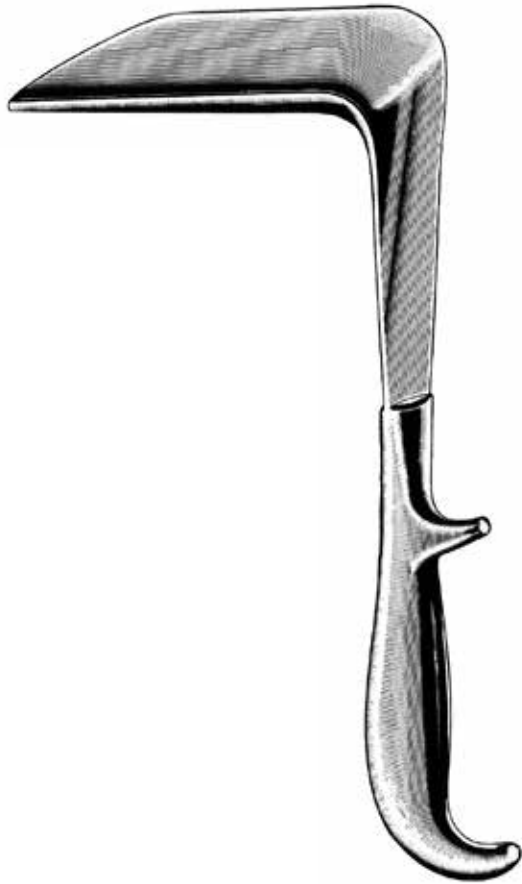

DOYEN

32-1201.01	Fig. 1	55 x 35 mm
32-1201.02	Fig. 2	85 x 35 mm
32-1201.03	Fig. 3	115 x 35 mm
32-1203.01	Fig. 1	55 x 45 mm
32-1203.02	Fig. 2	85 x 45 mm
32-1203.03	Fig. 3	115 x 45 mm
32-1203.04	Fig. 4	160 x 45 mm
32-1205.01	Fig. 1	55 x 60 mm
32-1205.02	Fig. 2	85 x 60 mm
32-1205.03	Fig. 3	115 x 60 mm
32-1205.04	Fig. 4	160 x 60 mm

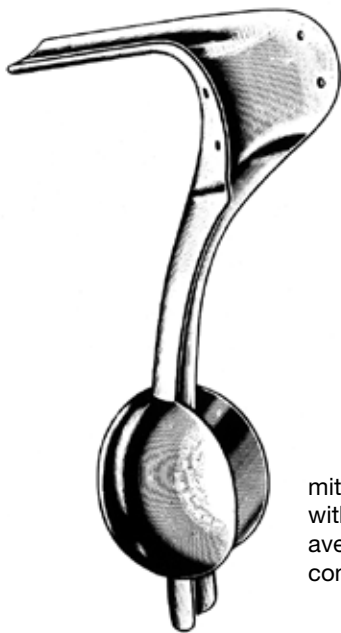

mit abnehmbarem Gewicht
 with detachable weight
 avec poids démontable
 con peso desmontable

AUVARD

32-1507.00

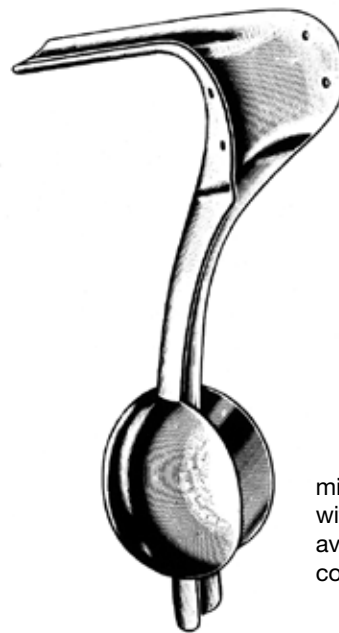

mit festem Gewicht
 with fixed weight
 avec poids fixe
 con peso fijo

AUVARD

32-1509.00



BREISKY

32-1510.20	100 x 20 mm
32-1510.25	100 x 25 mm
32-1510.30	100 x 30 mm
32-1510.35	100 x 35 mm
32-1510.40	100 x 40 mm
32-1513.20	130 x 20 mm
32-1513.25	130 x 25 mm
32-1513.30	130 x 30 mm
32-1513.35	130 x 35 mm
32-1513.40	130 x 40 mm
32-1515.40	155 x 40 mm



LANDAU

32-1519.28	100 x 28 mm
32-1519.38	100 x 38 mm



KOGAN

32-1560.24	24 cm, 9 1/2"
-------------------	---------------



FRIEDMANN

32-1551.10	10 cm, 4"
-------------------	-----------

Uterus-Dilatatoren
Uterine Dilators
Dilatateurs utérins
Dilatadores uterinos



32-1610.01	1 mm
32-1610.02	2 mm
32-1610.03	3 mm
32-1610.04	4 mm
32-1610.05	5 mm
32-1610.06	6 mm
32-1610.07	7 mm
32-1610.08	8 mm
32-1610.09	9 mm
32-1610.10	10 mm
32-1610.11	11 mm
32-1610.12	12 mm
32-1610.13	13 mm
32-1610.14	14 mm
32-1610.15	15 mm

HEGAR

32-1610.16	16 mm
32-1610.17	17 mm
32-1610.18	18 mm
32-1610.19	19 mm
32-1610.20	20 mm
32-1610.21	21 mm
32-1610.22	22 mm
32-1610.23	23 mm
32-1610.24	24 mm
32-1610.25	25 mm
32-1610.26	26 mm
32-1610.27	27 mm
32-1610.28	28 mm
32-1610.29	29 mm
32-1610.30	30 mm

HEGAR

32-1604.14 4 - 17 mm

32-1604.26 1 - 26 mm



32-1615.01	1,5 mm
32-1615.02	2,5 mm
32-1615.03	3,5 mm
32-1615.04	4,5 mm
32-1615.05	5,5 mm
32-1615.06	6,5 mm
32-1615.07	7,5 mm
32-1615.08	8,5 mm
32-1615.09	9,5 mm
32-1615.10	10,5 mm
32-1615.11	11,5 mm
32-1615.12	12,5 mm
32-1615.13	13,5 mm
32-1615.14	14,5 mm
32-1615.15	15,5 mm
32-1615.16	16,5 mm

HEGAR



HEGAR

32-1605.14 4 - 17 mm



HEGAR

32-1606.14 4 - 17 mm

32-1606.26 1 - 26 mm

Uterus-Dilatatoren
Uterine Dilators
Dilatateurs utérins
Dilatadores uterinos



HEGAR

32-1620.01	1/2 mm
32-1620.03	3/4 mm
32-1620.05	5/6 mm
32-1620.07	7/8 mm
32-1620.09	9/10 mm
32-1620.11	11/12 mm
32-1620.13	13/14 mm
32-1620.15	15/16 mm
32-1620.17	17/18 mm
32-1620.19	19/20 mm
32-1620.21	21/22 mm
32-1620.23	23/24 mm
32-1620.25	25/26 mm

HEGAR

32-1624.08	3/4 - 17/18 mm
32-1624.13	1/2 - 25/26 mm

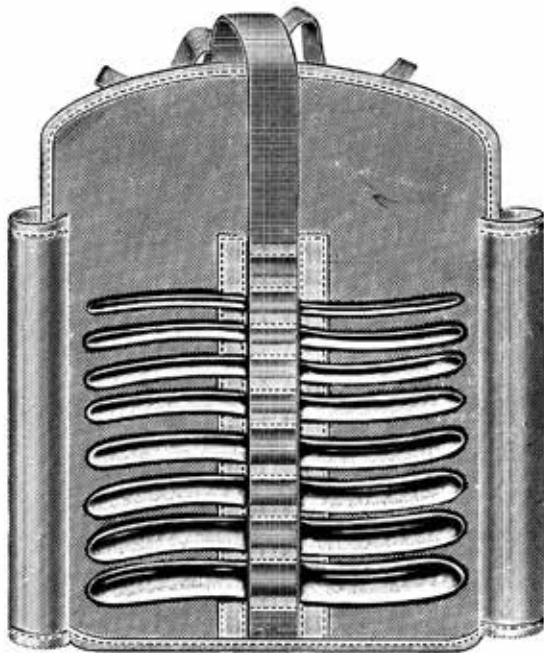

HEGAR

32-1625.08	3/4 - 17/18 mm
------------	----------------



HEGAR

32-1626.08	3/4 - 17/18 mm
32-1626.13	1/2 - 25/26 mm

Uterus-Dilatatoren
Uterine Dilators
Dilatateurs utérins
Dilatadores uterinos



HANK
32-1635.06
 4,5/5 - 9,5/10 mm

HANK	
32-1630.10	4,5/5 mm
32-1630.12	5,5/6 mm
32-1630.14	6,5/7 mm
32-1630.16	7,5/8 mm
32-1630.18	8,5/9 mm
32-1630.20	9,5/10 mm

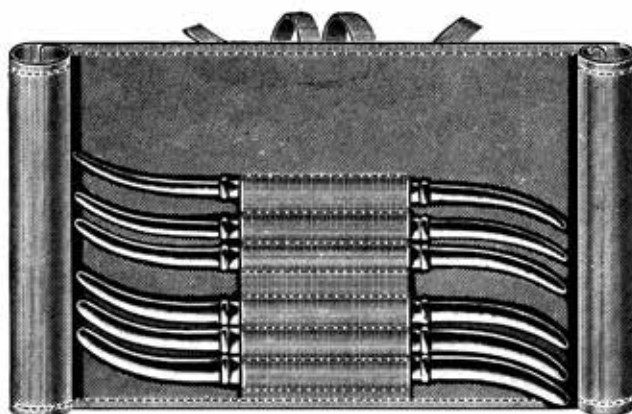

HANK
32-1636.08

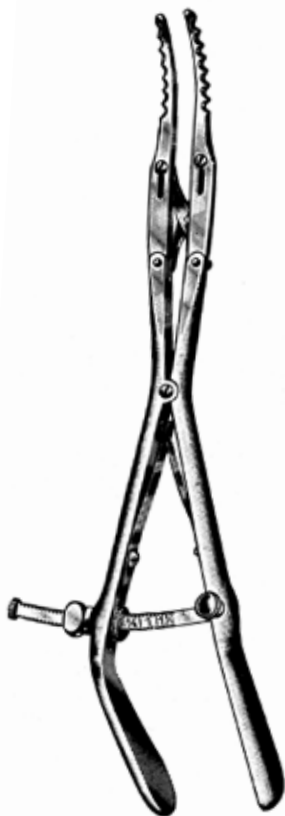

GOODELL
32-1641.34
 34 cm, 13 1/4"



WYLIE
32-1643.29
 29 cm, 11 1/4"

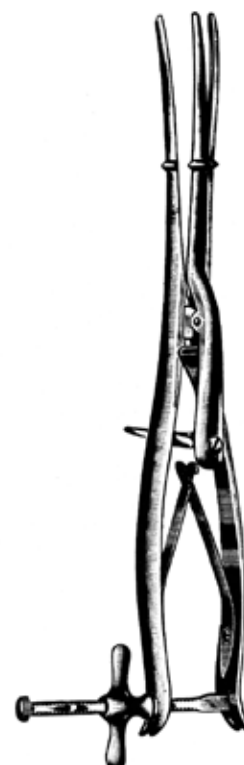

SIMS
32-1645.29
 29 cm, 11 1/4"

32

Hakenzangen
Tenaculum Forceps
Pinces pour abaissement du col de l'utérus
Pinzas para coger el cuello del útero



SCHROEDER

32-1702.25

25 cm, 10"



BRAUN

32-1704.25

25 cm, 10"



SKENE

32-1705.24

24 cm, 9 1/2"



DUPLAY

32-1707.28

28 cm, 11"



STAUDE-MOORE

32-1708.17

17 cm, 6 3/4"



BARRETT

32-1710.18

18 cm, 7"

Hakenzangen
Tenaculum Forceps
Pinces pour abaissement du col de l'utérus
Pinzas para coger el cuello del útero



JARCHO
32-1712.20
 20 cm, 8"



SCHROEDER
32-1714.24
 24 cm, 9 1/2"

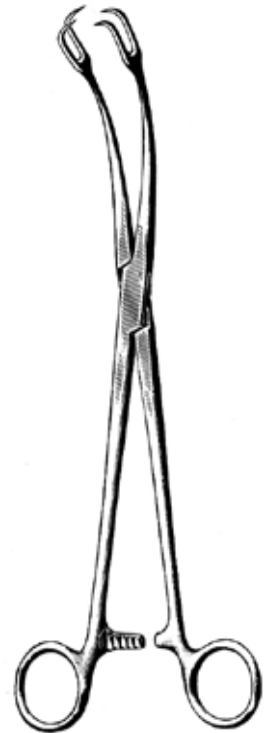

SCHROEDER
32-1715.24
 24 cm, 9 1/2"



MUSEUX
 24 cm, 9 1/2"



32-1724.06
 6 mm



32-1724.08
 8 mm



32-1724.10
 10 mm



MUSEUX
 24 cm, 9 1/2"



32-1725.06
 6 mm



32-1725.08
 8 mm



32-1725.10
 10 mm

Hakenzangen
Tenaculum Forceps
Pinces pour abaissement du col de l'utérus
Pinzas para coger el cuello del útero



TEALE
32-1731.23

23 cm, 9"



JACOBS
32-1732.21

21 cm, 8 1/4"



JACOBS
32-1733.21

21 cm, 8 1/4"

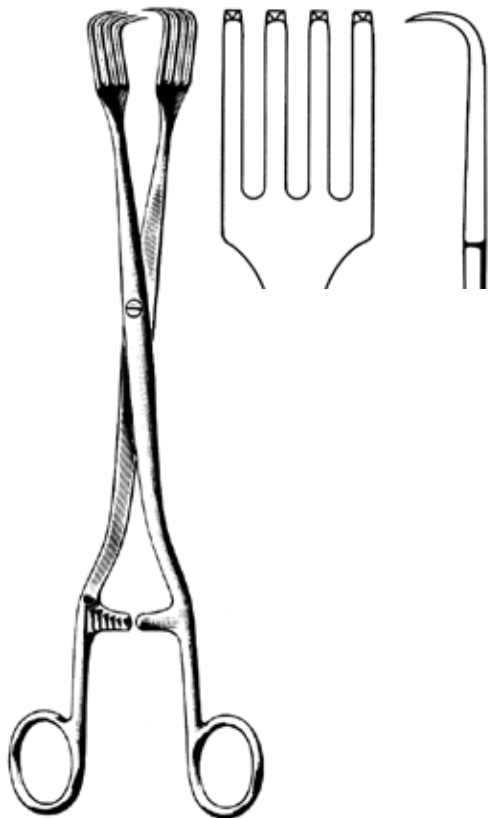

PRATT
32-1736.28

28 cm, 11"



IOWA
32-1739.26

26 cm, 10 1/4"



BEACHAM
32-1759.26

26 cm, 10 1/4"

Amniotom
 Amniotome
 Amniotome
 Amniótomo

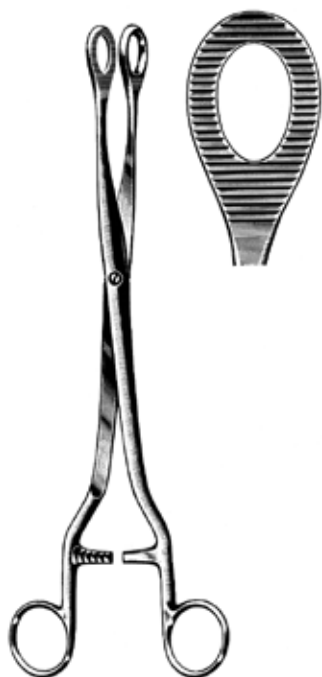

NOTO

32-1740.27

27 cm, 10 1/2"



DOYEN

32-1742.20

20 cm, 8"

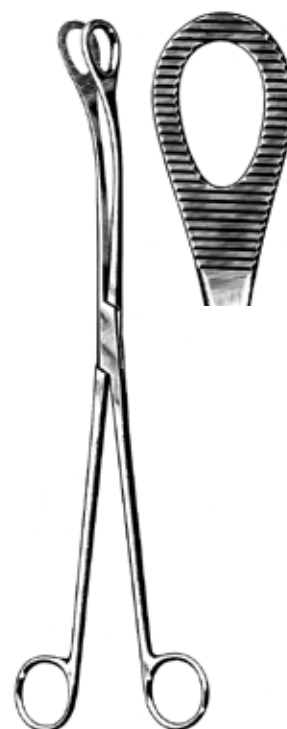

KELLY

32-1743.32

32 cm, 12 3/4"



DARTIGUES

32-1745.27

27 cm, 10 1/2"



SOMER

32-1747.23

23 cm, 9"



COLLIN

32-1749.25

25 cm, 10"



BRAUN
 32-1765.28
 28 cm, 11"

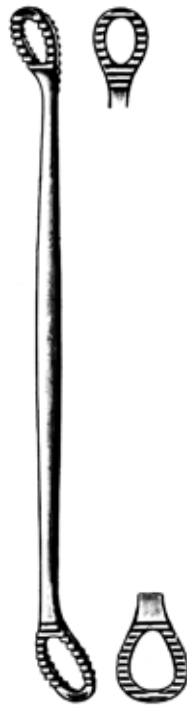

SIMS
 32-1767.26
 26 cm, 10 1/4"



COLLIN
 32-1784.28
 28 cm, 11"



starr
 rigid
 rigide
 rígida

SIMS
 32-1780.32
 32 cm, 12 3/4"



biegsam
 malleable
 malléable
 maleable

SIMS
 32-1781.32
 32 cm, 12 3/4"



starr
 rigid
 rigide
 rígida

MARTIN
 32-1782.32
 32 cm, 12 3/4"



biegsam
 malleable
 malléable
 maleable

MARTIN
 32-1783.32
 32 cm, 12 3/4"



RANDALL

32-1790.04

24 cm, 9 1/2"



NOVAK

32-1792.01 1 mm

32-1792.02 2 mm

32-1792.03 3 mm

32-1792.04 4 mm

24 cm, 9 1/2"



KEVORKIAN

32-1794.12 1,2 mm

32-1794.40 4,0 mm

30 cm, 12"



KEVORKIAN

32-1796.40

30 cm, 12"

Biopsiezangen
Biopsy Specimen Forceps
Pinces à biopsie
Pinzas sacabocados para biopsia



FAURE
32-1801.21
 21 cm, 8 1/4"



SCHUBERT
32-1804.21 21 cm, 8 1/4"
32-1804.28 28 cm, 11"



SCHUBERT
32-1805.26
 26 cm, 10 1/4"



THOMS-GAYLOR
32-1806.24
 24 cm, 9 1/2"



GELLHORN
32-1809.23
 23 cm, 9"



VAN DOREN
32-1811.25
 25 cm, 10"

Biopsiezangen
Biopsy Specimen Forceps
Pinces à biopsie
Pinzas sacabocados para biopsia

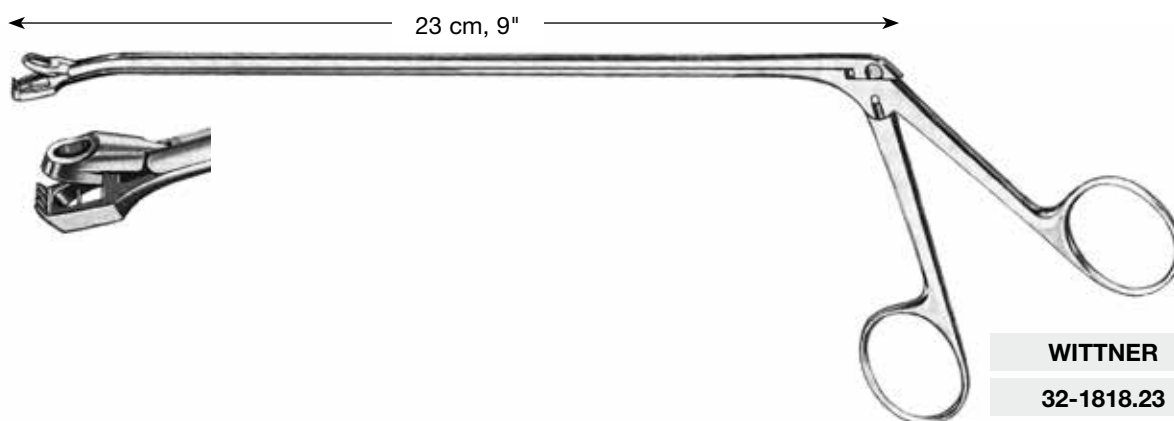
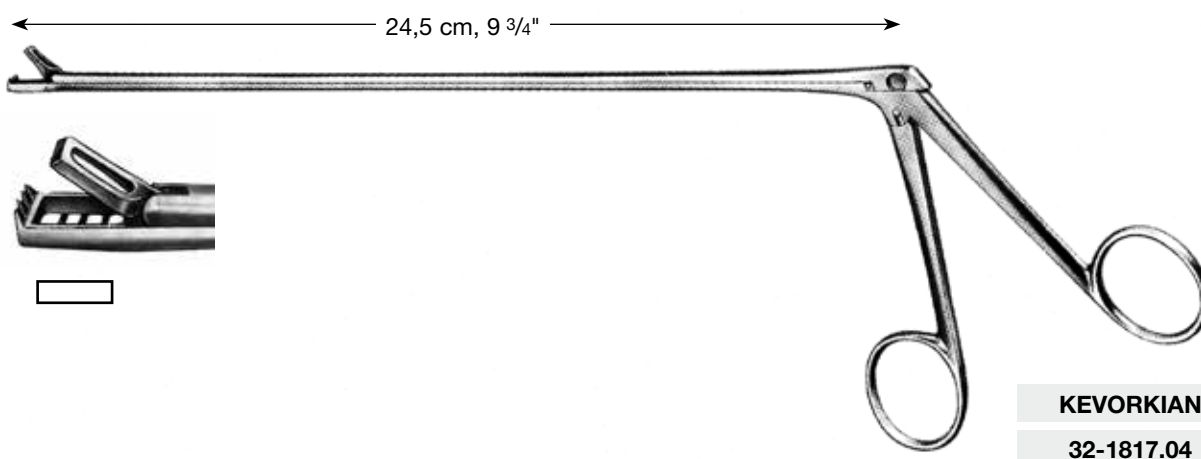
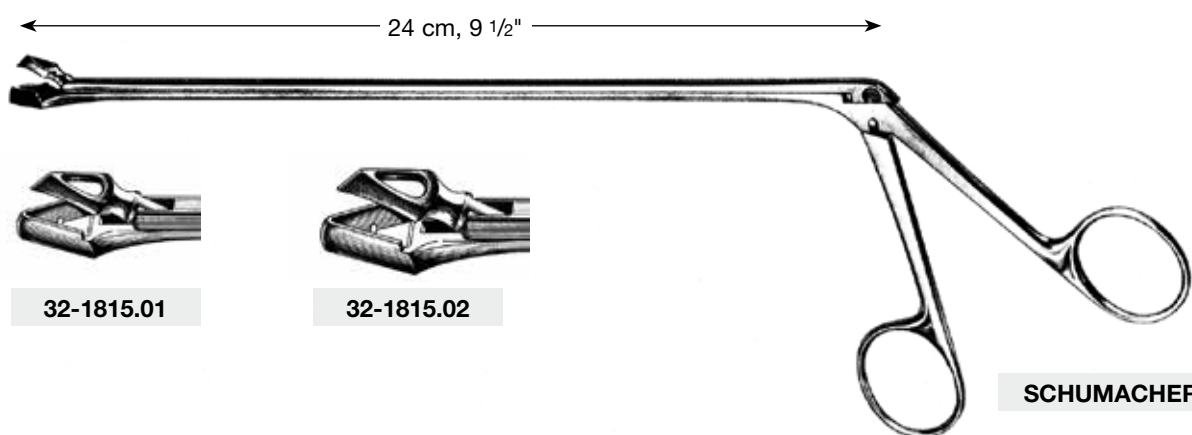
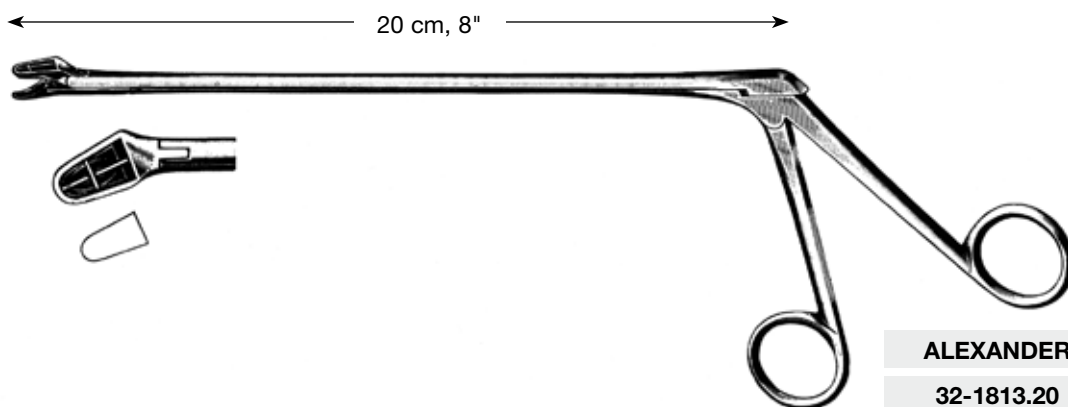

32

Biopsiezangen
Biopsy Specimen Forceps
Pinces à biopsie
Pinzas sacabocados para biopsia

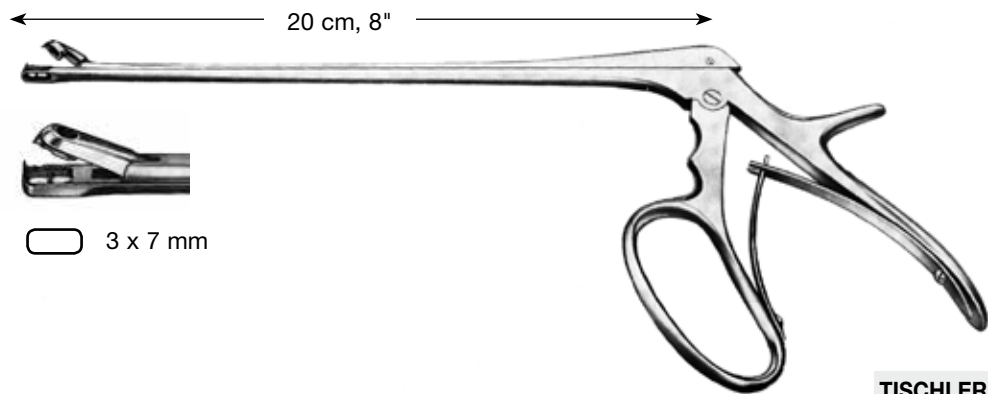

TISCHLER-MORGAN

32-1821.01

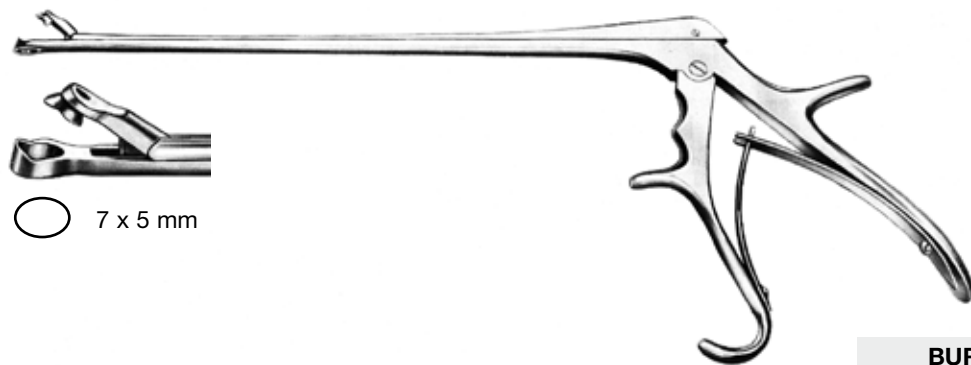

BURKE

32-1822.00

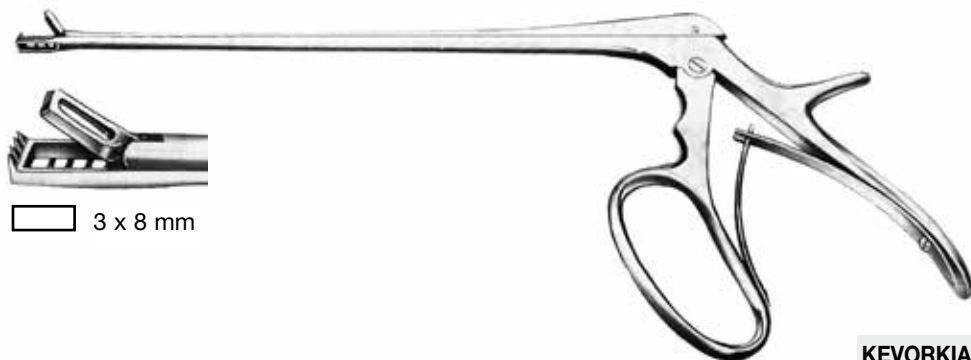

KEVORKIAN-PACIFIC

32-1825.04

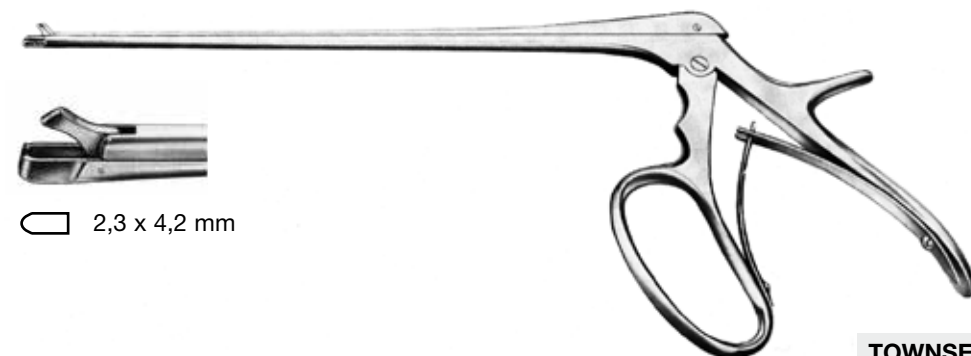

TOWNSEND-MINI

32-1826.00

Biopsiezangen
Biopsy Specimen Forceps
Pinces à biopsie
Pinzas sacabocados para biopsia



32



Instrument komplett
 Instrument complete
 Instrument complet
 Instrumento completo

Aufsatz allein
 Tip only
 Embout seul
 Punta sola

TOWNSEND-TISCHLER

32-1824.01

32-1824.11



Instrument komplett
 Instrument complete
 Instrument complet
 Instrumento completo

Aufsatz allein
 Tip only
 Embout seul
 Punta sola

TOWNSEND

32-1824.02

32-1824.12



Instrument komplett
 Instrument complete
 Instrument complet
 Instrumento completo

Aufsatz allein
 Tip only
 Embout seul
 Punta sola

TOWNSEND

32-1824.03

32-1824.13



Instrument komplett
 Instrument complete
 Instrument complet
 Instrumento completo

Aufsatz allein
 Tip only
 Embout seul
 Punta sola

TOWNSEND-KEVORKIAN

32-1824.04

32-1824.14

Biopsiezangen
Biopsy Specimen Forceps
Pinces à biopsie
Pinzas sacabocados para biopsia

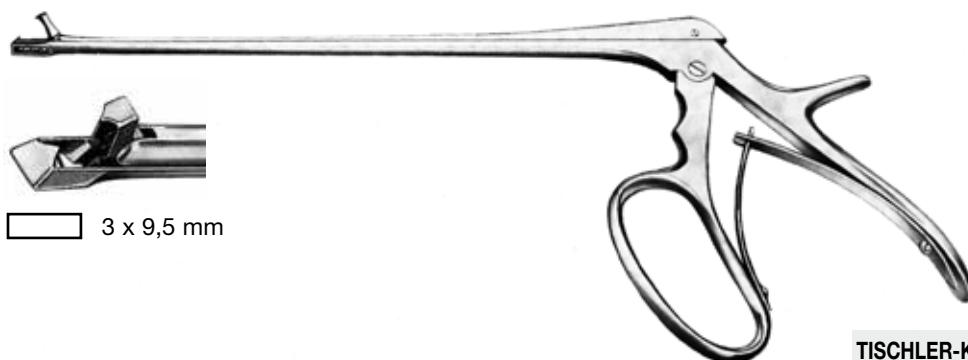

3 x 9,5 mm

TISCHLER-KEVORKIAN

32-1827.00

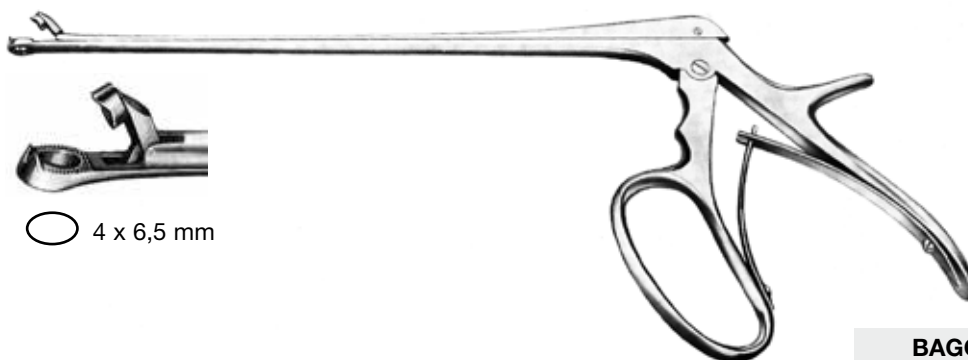

4 x 6,5 mm

BAGGISH

32-1828.00



4 x 8 mm

EPPENDORFER

32-1830.00

Biopsiezangen
 Biopsy Specimen Forceps
 Pincès à biopsie
 Pinzas sacabocados para biopsia



EPPENDORFER



Instrument komplett
 Instrument complete
 Instrument complet
 Instrumento completo

Aufsatz allein
 Tip only
 Embout seul
 Punta sola

TISCHLER-MORGAN

32-1832.01

32-1832.11



Instrument komplett
 Instrument complete
 Instrument complet
 Instrumento completo

Aufsatz allein
 Tip only
 Embout seul
 Punta sola

EPPENDORFER

32-1832.02

32-1832.12



Instrument komplett
 Instrument complete
 Instrument complet
 Instrumento completo

Aufsatz allein
 Tip only
 Embout seul
 Punta sola

EPPENDORFER

32-1832.03

32-1832.13



Instrument komplett
 Instrument complete
 Instrument complet
 Instrumento completo

Aufsatz allein
 Tip only
 Embout seul
 Punta sola

KEVORKIAN

32-1832.04

32-1832.14



DOYEN

32-1841.17

17 cm, 6 3/4"

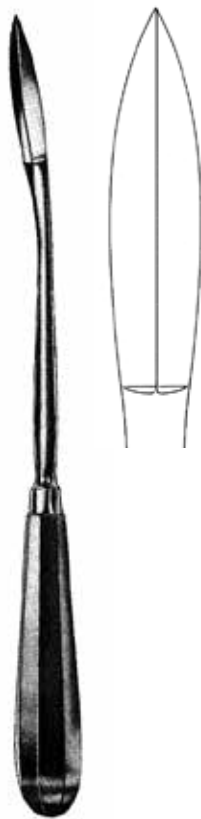

SEGOND

32-1843.27

27 cm, 10 1/2"



EMMET

22 cm, 8 1/2"

32-1845.01

Fig. 1

32-1845.02

Fig. 2

32-1845.03

Fig. 3

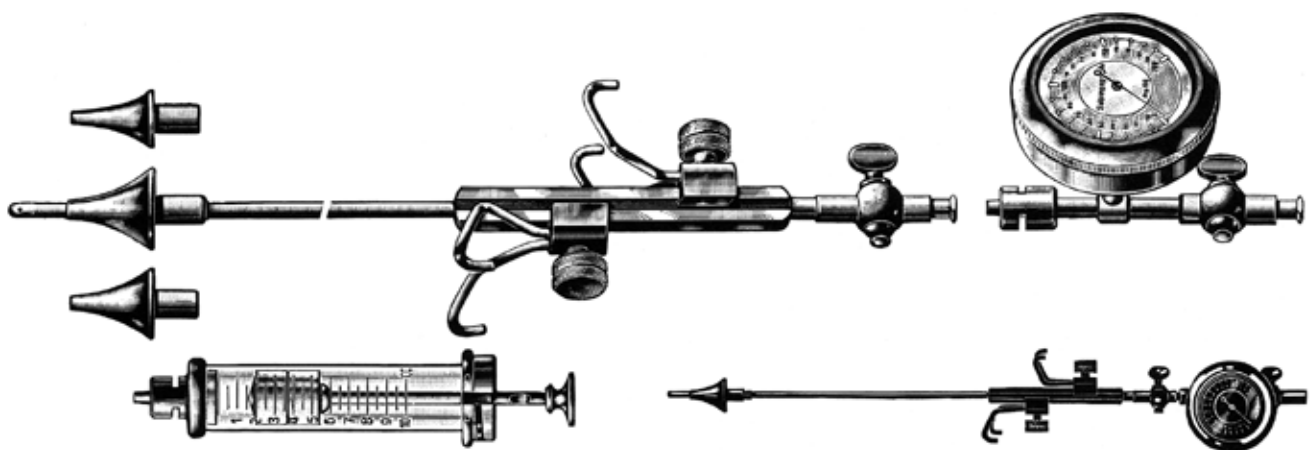

SCHULTZE

32-1850.00

Salpingograph
 Salpingograph
 Salpingographe
 Salpingógrafo



32-1902.01

Fig. 1



32-1902.02

Fig. 2



32-1902.03

Fig. 3



32-1902.04

Fig. 4



32-1902.05

Fig. 5



32-1902.06

Fig. 6



SIMON

25 cm, 10"



BLAKE

32-1904.27

27 cm, 10 1/2"

Uterus-Küretten
Uterine Curettes
Curettes utérines
Curetas uterinas

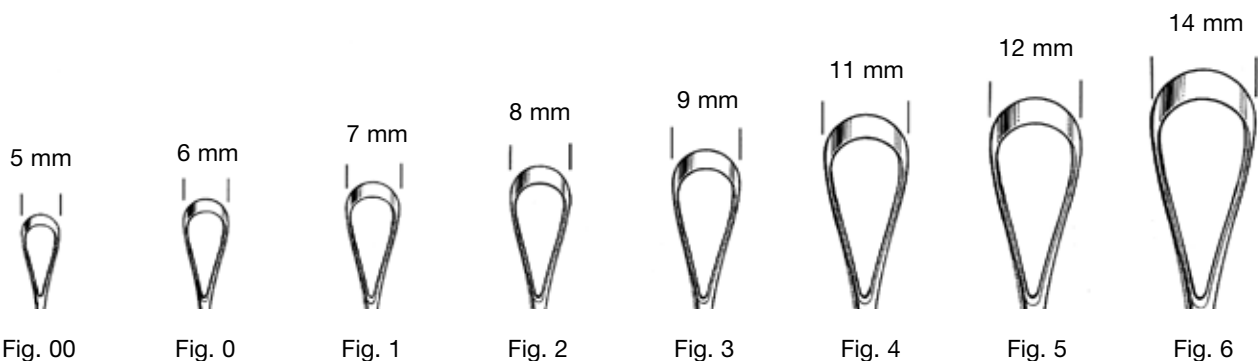

SIMS

28 cm, 11"

scharf, fest
 sharp, rigid
 tranchantes, rigides
 cortantes, rígidas

stumpf, fest
 blunt, rigid
 mouses, rigides
 romas, rígidas

scharf, biegsam
 sharp, malleable
 tranchantes, malléables
 cortantes, maleables

stumpf, biegsam
 blunt, malleable
 mouses, malléables
 romas, maleables

Fig. 00	32-1912.05	32-1914.05	32-1913.05	32-1915.05
Fig. 0	32-1912.06	32-1914.06	32-1913.06	32-1915.06
Fig. 1	32-1912.07	32-1914.07	32-1913.07	32-1915.07
Fig. 2	32-1912.08	32-1914.08	32-1913.08	32-1915.08
Fig. 3	32-1912.09	32-1914.09	32-1913.09	32-1915.09
Fig. 4	32-1912.11	32-1914.11	32-1913.11	32-1915.11
Fig. 5	32-1912.12	32-1914.12	32-1913.12	32-1915.12
Fig. 6	32-1912.14	32-1914.14	32-1913.14	32-1915.14

Uterus-Küretten
Uterine Curettes
Curettes utérines
Curetas uterinas

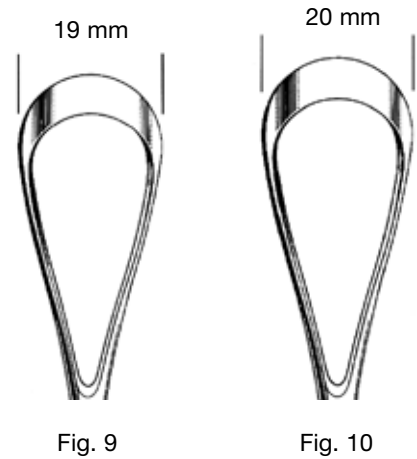
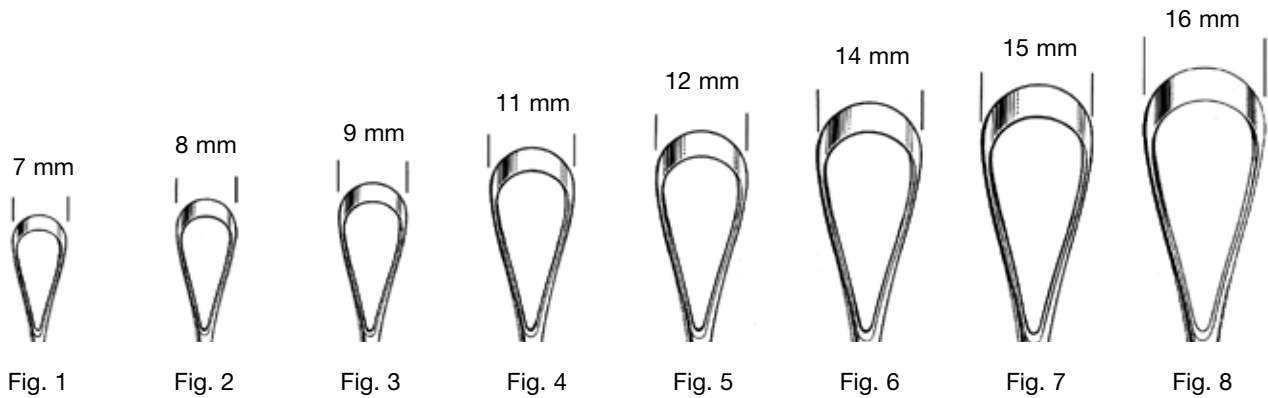

scharf, fest
sharp, rigid
tranchantes, rigides
cortantes, rígidas

stumpf, fest
blunt, rigid
mousses, rigides
romas, rígidas

scharf, biegsam
sharp, malleable
tranchantes, malléables
cortantes, maleables

stumpf, biegsam
blunt, malleable
mousses, malléables
romas, maleables

Fig. 1	32-1922.07	32-1924.07	32-1925.07	32-1927.07
Fig. 2	32-1922.08	32-1924.08	32-1925.08	32-1927.08
Fig. 3	32-1922.09	32-1924.09	32-1925.09	32-1927.09
Fig. 4	32-1922.11	32-1924.11	32-1925.11	32-1927.11
Fig. 5	32-1922.12	32-1924.12	32-1925.12	32-1927.12
Fig. 6	32-1922.14	32-1924.14	32-1925.14	32-1927.14
Fig. 7	32-1922.15	32-1924.15	32-1925.15	32-1927.15
Fig. 8	32-1922.16	32-1924.16	32-1925.16	32-1927.16
Fig. 9	32-1922.19	32-1924.19	32-1925.19	32-1927.19
Fig. 10	32-1922.20	32-1924.20	32-1925.20	32-1927.20

RECAMIER

31 cm, 12 1/2"

Uterus-Küretten
Uterine Curettes
Curettes utérines
Curetas uterinas



Fig. 14



Fig. 15



Fig. 16



BUMM

28 cm, 11"

scharf, fest
 sharp, rigid
 tranchantes, rigides
 cortantes, rígidas

stumpf, fest
 blunt, rigid
 mouses, rigides
 romas, rígidas

scharf, biegsam
 sharp, malleable
 tranchantes, malléables
 cortantes, maleables

stumpf, biegsam
 blunt, malleable
 mouses, malléables
 romas, maleables

Fig. 14	32-1932.30	32-1934.30	32-1933.30	32-1935.30
Fig. 15	32-1932.35	32-1934.35	32-1933.35	32-1935.35
Fig. 16	32-1932.40	32-1934.40	32-1933.40	32-1935.40





WRIGLEY

33-1110.23

23 cm, 9"



SIMPSON

33-1112.30

30 cm, 12"

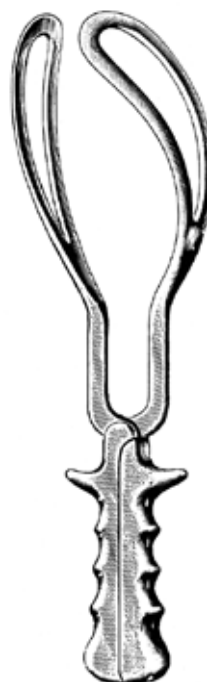

SIMPSON-BRAUN

33-1115.33 33 cm, 13"

33-1115.36 36 cm, 14"



DE LEE

33-1117.30

30 cm, 10 1/2"



DE LEE

33-1118.36 36 cm, 14"

33-1118.39 39 cm, 15 1/2"



ELLIOT

33-1125.32 32 cm, 12 3/4"

33-1125.38 38 cm, 15"



NAEGELE

33-1129.36 36 cm, 14"

33-1129.40 40 cm, 15 3/4"

Geburtszangen
Obstetrical Forceps
Forceps
Fórceps obstétricos



KIELLAND

33-1120.41

41 cm, 16 1/4"



LUIKART

33-1135.40

40 cm, 15 3/4"



KILLAND-LUIKART

33-1137.40

40 cm, 15 3/4"



SIMPSON-LUIKART

33-1145.36

36 cm, 14"



McLEAN-TUCKER-LUIKART

33-1149.40

40 cm, 15 3/4"



McLEAN-TUCKER

33-1151.39

39 cm, 15 1/2"



McLEAN-LUIKART

33-1153.39

39 cm, 15 1/2"



McLEAN

33-1155.36

36 cm, 14"



BARTON

33-1157.36

36 cm, 14"



BARTON

33-1158.17

17 cm, 6 3/4"



BOERMA

33-1161.29

29 cm, 11 1/4"



PIPER

33-1165.44

44 cm, 17 1/2"



PIPER

33-1167.40

40 cm, 15 3/4"



DEWEY

33-1170.37

37 cm, 14 1/4"

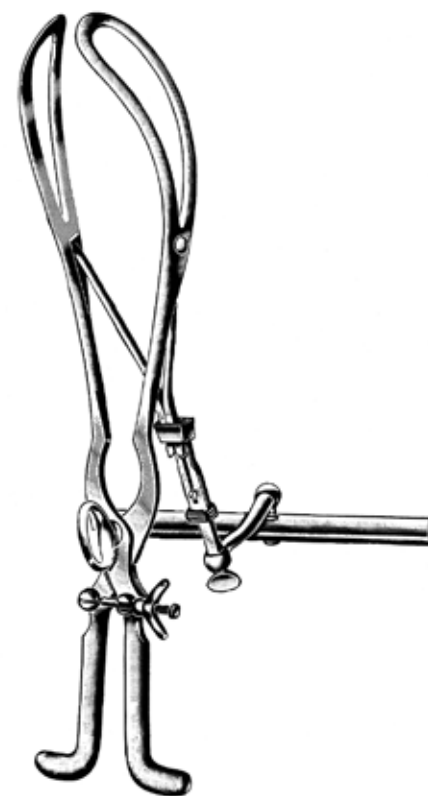

TARNIER

33-1172.40

40 cm, 15 3/4"

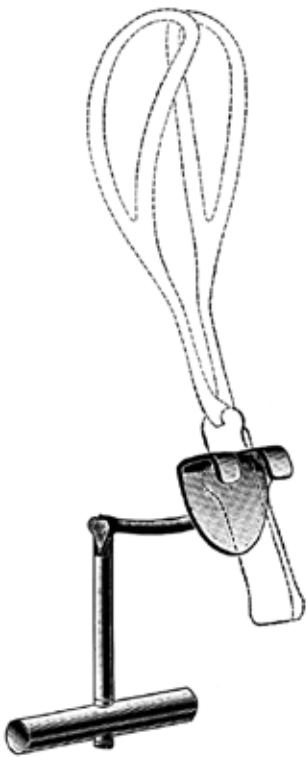

BILL

33-1180.00



LUIKART-BILL

33-1181.21

21 cm, 8"



SMELLIE

33-1191.33

33 cm, 13"



SELLHEIM

33-1249.28

28 cm, 11"



GAUSS

33-1193.27

27 cm, 10 1/2"

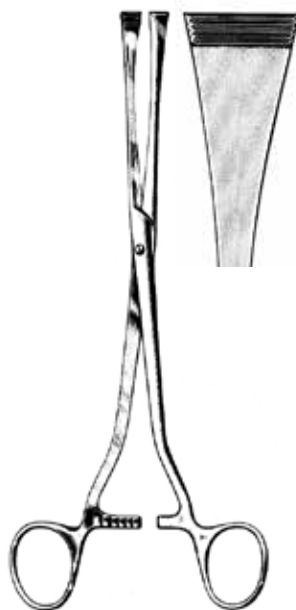

GREEN-ARMYTAGE

33-1194.21

21 cm, 8"



COLLIN

33-1197.09

9 cm, 3 1/2"



KANE

33-1199.09

8,5 cm, 3 1/4"



MARTIN

33-1201.34

34 cm, 13 1/4"



COLLIER

33-1203.30

30 cm, 12"



COLLIN

33-1205.35

35 cm, 13 3/4"

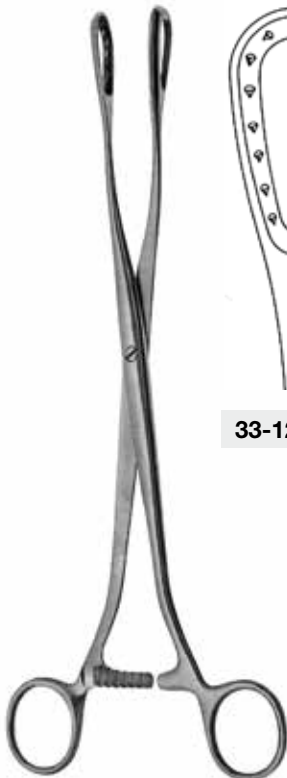

SAENGER

27 cm, 10 1/2"

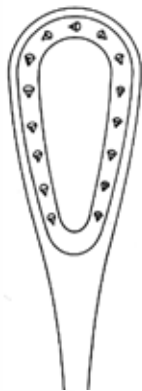

33-1232.27

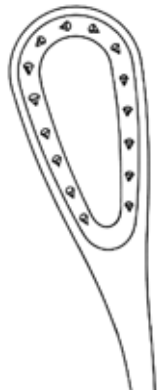

33-1233.27



WINTER

28 cm, 11"



33-1234.01

Fig. 1



33-1234.02

Fig. 2

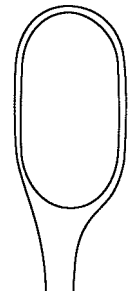

33-1234.03

Fig. 3



33-1235.01

Fig. 1



33-1235.02

Fig. 2



33-1235.03

Fig. 3

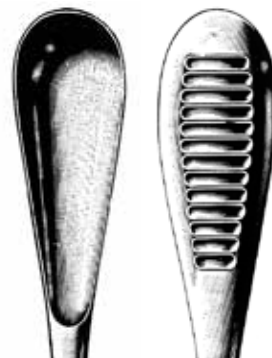

33-1244.14

14,5 mm

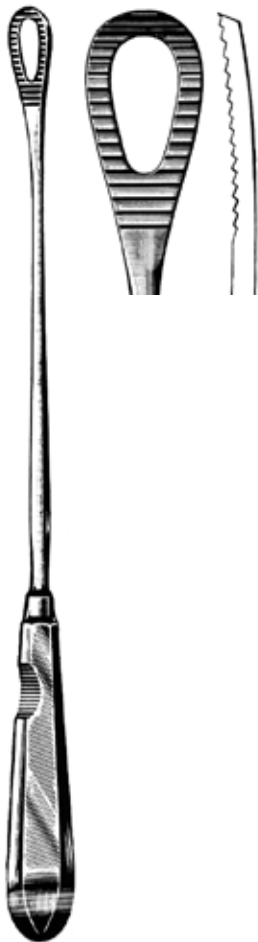

PESTALOZZA

33-1242.30

30 cm, 12"



CUZZI

30 cm, 12"



33-1244.18

18 mm



33-1244.21

21 mm

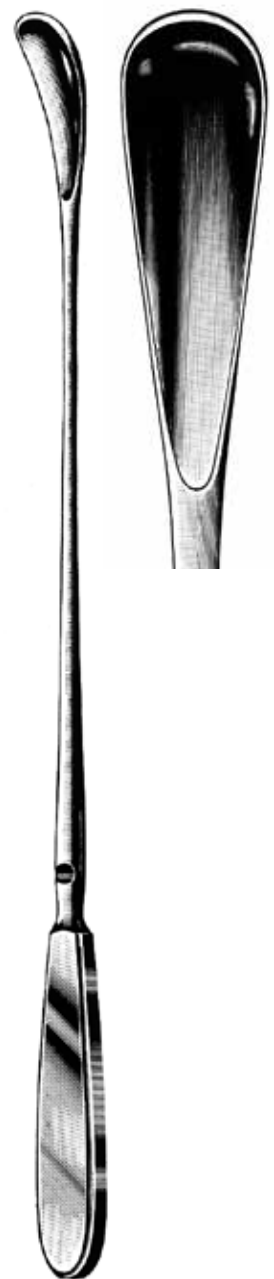

WALLICH

33-1246.42

42 cm, 17"



BRAUN

33-1250.42

42 cm, 17"

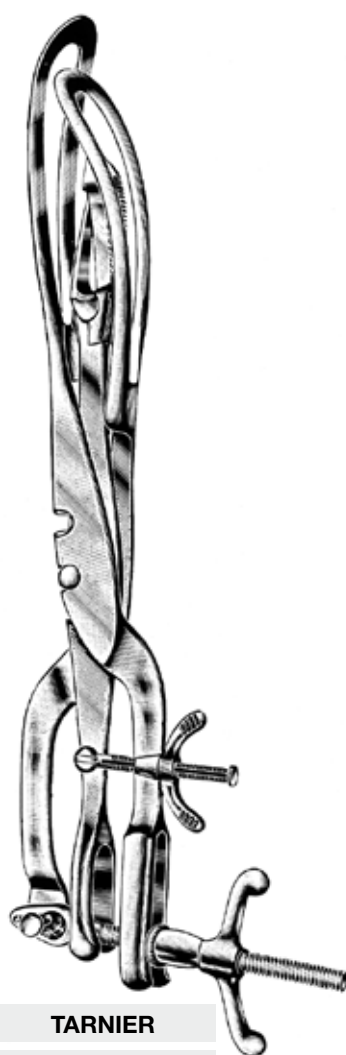

TARNIER

33-1254.46

46 cm, 18"

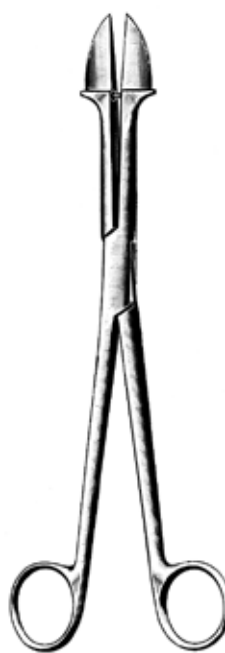

SMELLIE

33-1256.25

25 cm, 10"

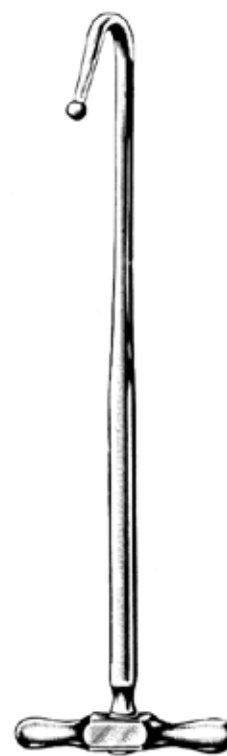

BRAUN

33-1259.30

30 cm, 12"

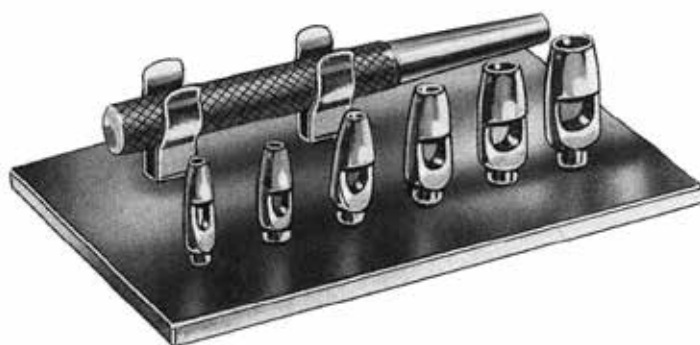



KILNER

34-1230.15

15 cm, 5 3/4"



SCHAMBERG

34-1241.10

10 cm, 4"



UNNA

34-1243.14

14 cm, 5 1/2"



UNNA

34-1245.14

14 cm, 5 1/2"



WALTON

34-1248.14

14 cm, 5 1/2"



SAALFELD

34-1251.10

10 cm, 4"



FOX



34-1258.03

3 mm



34-1258.04

4 mm



34-1258.05

5 mm



34-1258.06

6 mm



PIFFARD



34-1260.03

Fig. 1



34-1260.04

Fig. 2



34-1260.05

Fig. 3



KEYES

34-1268.00

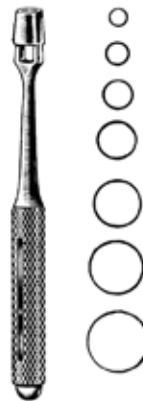

KEYES

34-1270.02 2 mm

34-1270.03 3 mm

34-1270.04 4 mm

34-1270.05 5 mm

34-1270.06 6 mm

34-1270.07 7 mm

34-1270.08 8 mm

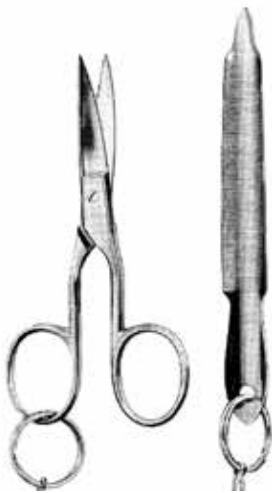

34-1310.10



34-1314.10

10 cm, 4"



34-1315.10

10 cm, 4"



34-1356.10 10 cm, 4"

34-1356.12 12 cm, 4 3/4"



34-1348.10

10 cm, 4"



34-1349.10

10 cm, 4"



CREDO

34-1370.00

Ersatzklingen, 10 Stück
 Spare Blades, 10 pieces
 Lames de rechange, 10 pièces
 Hojas de repuesto, 10 piezas

CREDO

34-1369.14

14,5 cm, 5 1/2"



34-1317.14

14 cm, 5 1/2"



34-1320.14

14 cm, 5 1/2"



TURNBULL

34-1323.11 11,5 cm, 4 1/2"

34-1323.13 13,5 cm, 5 1/4"



34-1330.13

13 cm, 5"



34-1335.11

11 cm, 4 1/4"



34-1343.10

10,5 cm, 4"



Verschiedene Behälter
Different Containers
Boîtes diverses
Varios contenedores



SAUERBRUCH

35-1120.21

210 x 125 x 17 mm



35-1124.00

150 x 95 x 13 mm



35-1122.65

65 x 15 mm



35-1123.65

65 x 15 mm



35-1251.10

100 x 20 mm

Verschiedene Behälter
Different Containers
Boites diverses
Varios contenedores



35-1130.18	180 x 80 x 40 mm
35-1130.20	200 x 100 x 60 mm
35-1130.22	220 x 120 x 40 mm
35-1130.25	250 x 120 x 40 mm
35-1130.30	300 x 125 x 40 mm
35-1130.32	320 x 150 x 40 mm
35-1130.40	400 x 60 x 75 mm
35-1130.50	500 x 200 x 120 mm



35-1144.01	45 x 25 mm
35-1144.02	50 x 28 mm
35-1144.03	55 x 30 mm
35-1144.04	60 x 32 mm
35-1144.05	70 x 36 mm
35-1144.06	80 x 40 mm
35-1144.07	100 x 50 mm



35-1140.04	40 mm
35-1140.06	60 mm
35-1140.08	80 mm
35-1140.10	100 mm
35-1140.12	120 mm
35-1140.15	150 mm



35-1143.16	0,75 l	165 x 60 mm
35-1143.17	1,0 l	175 x 70 mm
35-1143.22	2,0 l	220 x 80 mm
35-1143.23	2,5 l	225 x 90 mm
35-1143.24	3,0 l	240 x 110 mm
35-1143.25	4,0 l	255 x 115 mm
35-1143.27	5,0 l	275 x 115 mm
35-1143.29	6,0 l	290 x 125 mm
35-1143.31	6,0 l	310 x 120 mm
35-1143.34	8,5 l	345 x 125 mm
35-1143.38	11,0 l	380 x 130 mm
35-1143.41	14,0 l	415 x 140 mm

Verschiedene Behälter
Different Containers
Boites diverses
Varios contenedores



35-1149.17	0,3 l	170 mm
35-1149.25	0,8 l	250 mm
35-1149.27	1,1 l	270 mm



35-1150.02	0,25 l
35-1150.05	0,50 l
35-1150.10	1,00 l
35-1150.20	2,00 l

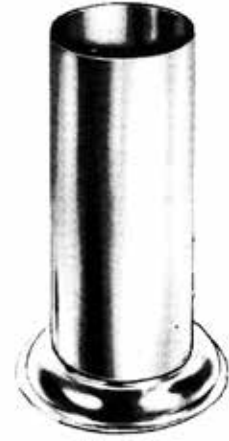

35-1252.01	30 x 90 mm
35-1252.02	50 x 100 mm
35-1252.03	50 x 130 mm
35-1252.04	50 x 175 mm
35-1252.05	75 x 100 mm
35-1252.06	75 x 130 mm
35-1252.07	75 x 175 mm
35-1252.08	100 x 175 mm
35-1252.09	100 x 200 mm



35-1254.20	200 x 150 x 25 mm
35-1254.26	260 x 180 x 30 mm
35-1254.30	300 x 220 x 30 mm
35-1254.35	350 x 220 x 40 mm



35-1256.22	220 x 170 x 50 mm
35-1256.28	280 x 200 x 50 mm
35-1256.32	320 x 240 x 50 mm
35-1256.37	370 x 270 x 50 mm
35-1256.42	420 x 320 x 50 mm

35

Verschiedene Behälter
Different Containers
Boites diverses
Varios contenedores



SCHIMMELBUSCH

35-1325.08	Ø 125 x 80 mm
35-1325.10	Ø 125 x 100 mm
35-1325.25	Ø 125 x 125 mm
35-1350.08	Ø 150 x 80 mm
35-1350.10	Ø 150 x 100 mm
35-1350.13	Ø 150 x 130 mm
35-1350.15	Ø 150 x 150 mm
35-1350.19	Ø 150 x 190 mm

35-1359.14	Ø 190 x 145 mm
35-1359.16	Ø 190 x 165 mm
35-1359.19	Ø 190 x 190 mm
35-1359.24	Ø 190 x 240 mm
35-1365.14	Ø 240 x 145 mm
35-1365.16	Ø 240 x 165 mm
35-1365.19	Ø 240 x 190 mm
35-1365.24	Ø 240 x 240 mm
35-1365.29	Ø 240 x 290 mm
35-1365.34	Ø 240 x 340 mm
35-1365.39	Ø 240 x 390 mm
35-1366.14	Ø 290 x 145 mm
35-1366.16	Ø 290 x 165 mm
35-1366.19	Ø 290 x 190 mm
35-1366.24	Ø 290 x 240 mm
35-1366.29	Ø 290 x 290 mm
35-1366.34	Ø 290 x 340 mm

35-1366.39	Ø 290 x 390 mm
35-1370.14	Ø 340 x 145 mm
35-1370.16	Ø 340 x 165 mm
35-1370.19	Ø 340 x 190 mm
35-1370.24	Ø 340 x 240 mm
35-1370.29	Ø 340 x 290 mm
35-1370.34	Ø 340 x 340 mm
35-1370.39	Ø 340 x 390 mm
35-1371.14	Ø 390 x 145 mm
35-1371.16	Ø 390 x 165 mm
35-1371.19	Ø 390 x 190 mm
35-1371.24	Ø 390 x 240 mm
35-1371.29	Ø 390 x 290 mm
35-1371.34	Ø 390 x 340 mm
35-1371.39	Ø 390 x 390 mm
35-1371.49	Ø 390 x 490 mm
35-1371.59	Ø 390 x 590 mm



KONRICH

35-1383.08	Ø 125 x 80 mm
35-1383.10	Ø 125 x 100 mm
35-1383.25	Ø 125 x 125 mm
35-1384.08	Ø 150 x 80 mm
35-1384.10	Ø 150 x 100 mm
35-1384.13	Ø 150 x 130 mm
35-1384.15	Ø 150 x 150 mm
35-1384.19	Ø 150 x 190 mm

35-1385.14	Ø 190 x 145 mm
35-1385.16	Ø 190 x 165 mm
35-1385.19	Ø 190 x 190 mm
35-1385.24	Ø 190 x 240 mm
35-1388.14	Ø 240 x 145 mm
35-1388.16	Ø 240 x 165 mm
35-1388.19	Ø 240 x 190 mm
35-1388.24	Ø 240 x 240 mm
35-1388.29	Ø 240 x 290 mm
35-1388.34	Ø 240 x 340 mm
35-1388.39	Ø 240 x 390 mm
35-1390.14	Ø 290 x 145 mm
35-1390.16	Ø 290 x 165 mm
35-1390.19	Ø 290 x 190 mm
35-1390.24	Ø 290 x 240 mm
35-1390.29	Ø 290 x 290 mm
35-1390.34	Ø 290 x 340 mm

35-1390.39	Ø 290 x 390 mm
35-1391.14	Ø 340 x 145 mm
35-1391.16	Ø 340 x 165 mm
35-1391.19	Ø 340 x 190 mm
35-1391.24	Ø 340 x 240 mm
35-1391.29	Ø 340 x 290 mm
35-1391.34	Ø 340 x 340 mm
35-1391.39	Ø 340 x 390 mm
35-1395.14	Ø 390 x 145 mm
35-1395.16	Ø 390 x 165 mm
35-1395.19	Ø 390 x 190 mm
35-1395.24	Ø 390 x 240 mm
35-1395.29	Ø 390 x 290 mm
35-1395.34	Ø 390 x 340 mm
35-1395.39	Ø 390 x 390 mm
35-1395.49	Ø 390 x 490 mm
35-1395.59	Ø 390 x 590 mm

35



35-2010.26	260 x 260 x 50 mm
------------	-------------------

35-2010.48	480 x 260 x 50 mm
------------	-------------------

Inhaltsverzeichnis

A

Adenotom	362
ADLERKREUTZ , Fasspinzetten	62
ADSON , Arterienklemmen	83
Haken	270
Elevatoren	215
Hohlmeißelzangen	186
Pinzetten	274
Mikro-Pinzetten	57, 61
Nadelhalter	154
Pinzetten	57-58, 61-62
Saugrohr	275
Wundsperrer	128
ADSON-BABY , Arterienklemme	83
ADSON-BROWN , Fasspinzetten	62
AEBLI , Hornhautscheren	30
ALLAN-PARKS , Rektalspekulum	429
ALBEE , Fräser	231-232
ALEXANDER , Biopsiezange	452
Flachmeißel	203
Hohlmeißel	203
Raspatorien	204
ALLIS , Gewebezangen	408
ALLIS-ADAIR , Gewebezange	408
ALLISON , Lungenspatel	397
ALM , Wundspreizer	127
ALVIS , Fremdkörperkürette	291
Amniotom	447
Amputation, Messer	20
Retraktor	224
Sägen	225
ANDREW , Zungendrucker	364
Aneurysmaclips	279-281
Anlegezangen für Clips	268, 281
Anuskope	430
ARCHER , Splitterzangen	65
ARLT , Drahtschlingen	295
ARRUGA , Extraktionshaken	292
Kapselpinzetten	309
Lidsperrer	284
Nadelhalter	157, 164
Wundlöffel	296
Arterienklemmen	67-96
ASCH , Septumrichtzange	359
Aufreiber, für Marknägel	238
AUFRIEHT , Nasenraspel	356
Nasenrückenhaken	359
Ausschläger/Einschläger, für Marknägel	239
Autopsiebesteck	209
AUVARD , Scheidenspekula	440
AXENFELD , Chalazionslöffel	295
AYER , Chalazionspinzetten	312

B

BABCOCK , Darmzangen	409
BABINSKY , Hammer	6
BACKHAUS , Tuchklemmen	98
BAGGISH , Biopsiestanze	455
BAILEY , Rippensperrer	396
BAILEY-GIBBON , Rippensperrer	396
BAINBRIDGE , Arterienklemmen	91
BAKES , Gallensteinsonden	404
BALFOUR , Bauchdeckenhalter	138
BALLENGER , Septumelevatorium	353
Septumhohlmeißel	355
Septumschwungmesser	351
Tonsillenfasszange	374
Bandmaß	7
BANGERTER , Cycloclialysespatel	296
BARANY , Lärrtrommel	321
BARBARA , Häkchen	336
Nadeln	336
BARKAN , Goniometriemesser	289
BARNHILL , Ringmesser	361
BARR , Rektalspekulum	428
BARRAQUER , Cilienpinzette	315
Colibri Irispinzetten	303
Colibri Lidsperrer	284

Colibri Irisschere	52
Fixierpinzette	308
Keratoplastikmesser	290
Nadelhalter	158, 164
Vorderkammerpinzette	306
BARRAQUER-KATZIN , Irispinzette	302
BARRETT , Hakenzange	445
BARTON , Geburtszange	466
Zughebel	466
Batteriegriffe, für Laryngoskope	13
Bauchdecken, -haken	122, 124
-halter	134-137
Bauchspatel	109
BAUMGARTNER , Nadelhalter	153, 159
BEACHAM , Amniotom	447
Beckenzirkel	468
BECKER , Cystotom	293
BECKMANN , Ringmesser	360
Wundsperrer	130
BECKMANN-EATON , Wundsperrer	130
BEEBEE , Drahtscheren	41
BEER , Cilienpinzette	315
BEESON , Gipsspreizer	181
BELLUCCI , Mikroscheren	328
BENGOLEA , Arterienklemmen	82
BENNET , Knochenheber	216
BERENS , Keratome	286
BERGMANN , Gipssäge	180
Verbandschere	41
BERKE , Muskelpinzetten	306
BERLINER , Reflexhammer	6
BERNHARD , Tuchklemme	99
BERTILLON , Messzirkel	7
BEST , Darmklemmen	413
Besteck, Autopsie	209
Diagnostik	2-3
Otoskop	3
Varizen	141
BETHUNE , Rippenschere	390
BEUSE , Schere gezahnt	32
BEYER , Hohlmeißelzange	186
Stanze	348
Biegezangen	236
BILL , Zughebel	467
BILLEAU , Ohrschlingen	324
Biopsiezangen	382-384, 432, 451-456
BIRCHER-GANSKE , Knochenhalte-zangen	196
Meniskotome	221
BISHOP-HARMAN , Irispinzetten	304
BLAKE , Gallensteinzangen	402
Uteruskürette	458
Bleihand	198
BLOHMKE , Tonsillenzange	374
BLOUNT , Kniehaken	220
Knochenheber	219
BLUMENTHAL , Hohlmeißelzangen	185
BLUNT , Sterilisierklammer	178
Blutdruckmesser	2
BODENHAMMER , Rektalspekulum	428
BOEHLER , Extensionsbügel	235
Hohlmeißelzangen	187
Knochennägel	250
Knochensplitterzangen	190
BOERMA , Geburtszange	466
BOETTCHER , Tonsillenschere	32
Bohrapparate	227-230
Bohrdrahtstützen	229
Bohrer	227-228, 231
Bohrwinde	228
BONACCOLTO , Strabismuspinzetten	303-304
BONN , Irispinzetten	305
Spülkanülen	313
BORCHARDT , Fräser	232
BOSE , Trachealhäkchen	387
Trachealspreizer	386
BOUCHERON , Ohrtrichter	319
Bougies	425
BOWLES , Stethoskop	5
BOWMANN , Diszisionsmesser	287
Diszisionsnadeln	290
Lidsperrer	284
Tränenkanalsonden	299
BOYNTON , Nadelhalter	157
BOZEMANN , Nadelhalter	161

Schwammzange	103
BOZEMANN-DOUGLAS , Schwammzange	103
BRAUN , Dekapitationshaken	470
Hakenzange	445
Kranioklast	470
Uterusdepressor	449
BRAUN-STADLER , Episiotomiescheren	35
BREISKY , Scheidenspekula	441
Bronchusklemmen	87-88, 398-399
BRUENINGS , Nasenzangen	345
Ohrtrichter	319
Septummesser	351
Tonsillenschnürer	375
Zangenaufsätze	379
Zungendrucker	364
BRUNETTI , Wirbelkörpermeißel	209
BRUNNER , Darmklemmen	413
Führungshohlsonden	169
Rippenschere	391
BRUNS , Scharfe Löffel	199-200
Verbandscheren	42, 49
BRYANT , Schwammzange	102
BUCHWALD , Zungendrucker	364
BUCK , Hammer	6
Fremdkörperheber	327
Ohrküretten	323
BUIE , Saugkanüle	431
BUMM , Uterusküretten	461
BUNGE , Exenterationslöffel	294
BUNNEL , Bohraparat	230
Sehnenstripper	222
BUNT , Sterilisierklammer	178
BURCH , Fixiergabel	289
BURKE , Biopsiestanze	453
BUSCH , Nabelschnurscheren	35

C

CARMALT , Splitterpinzetten	64
CARPENTER , Tonsillendissektor	372
CASTANEDA , Rippensperrerr	395
CASTROVIEJO , Cycloalysenspatel	297
Fixierpinzetten	307
Hornhautscheren	53
Iridektomiescheren	53
Kapselpinzetten	309
Klingenbrecher	18
Lanzenmesser	286
Lidsperrerr	285
Markierinstrument	298
Nadelhalter	158, 164
Nahtpinzetten	310
Tränenkanaldilatator	299
Trepshin	314
CHAPUT , Arterienklemme	81
CHARRIERE , Amputationssägen	225
CHEATLE , Sterilisierzange	177
CHERON , Schwammzange	102
CHEVALIER-JACKSON , Kehlkopfzangen	380
CHILDE , Wundklammerpinzette	175
Cilienpinzetten	315
CINELLI , Nasenplastikmeißel	355
CITELLI , Stanze	348
CLAR , Stirnlampen	4
CLARK , Lidsperrerr	284
CLEVELAND , Hohlmeißelzangen	184
Clipanlegezangen	268, 281
Clips, Aneurysma-	279-281
Kopfhaut-	269
Silber-	269
CLOWARD , Wirbelkörperspreizer	275
Wundsperrerr	132
COACKLEY , Antrumkürette	360
Antrumtrokar	147
COLCLOUGH , Laminektomiestanzen	278
COLLIER , Nadelhalter	152
COLLIN , Arterienklemme	81
Bauchdeckenhalter	134
Beckenzirkel	468
Dynamometer	3
Hammer	210
Nabelschnurklemme	467
Scheidenspekula	434
Schwammzange	102

Uteruszange	448
Uterussonde	449
Wundklammerzange	175
Zungenzange	81
COLLIN-HARTMANN , Wundhaken	108
COLLYER , Beckenzirkel	468
COLVER , Tonsillenfasszangen	374
CONNIN-AMSLER , Markierinstrument	298
CONVERSE , Nasenplastikmesser	350
COOLEY , Atrauma Pinzette	66
COOPER , Unterbindungsnadel	167
CORDES , Zangenaufsätze	379
CORWIN , Tonsillenkompessorium	375
CORYLLOS , Thoraxwundhaken	125
Rippenschere	390
COS , Drahtbiegezüngchen	329
COTTLE , Haken	358
Nasenplastikmeißel	350, 353-354
Nasenplastikmesser	351
Nasenschere	31
Nasenspekula	342
Periostelevatorien	353-353
COTTLE-KATZANJIAN , Knochensplitterzange	190
COTTLE-NEIVERT , Wundhaken	358
COXETER , Prostatakatheter	426
CRAFOORD , Bronchusklemme	88
Thoraxschere	38
CREDO , Hornhauthobel	473
CRILE , Arterienklemmen	72
Nadelhalter	156
Wundhaken	108
CRILE-MURRAY , Nadelhalter	153, 159
CRILE-RANKIN , Arterienklemmen	73
CRILE-WOOD , Nadelhalter	153, 159
CRITCHETT , Lidsperrerr	284
CRUTCHFIELD , Schädelhalter	269
Vorbohrer	269
CULLER , Irisspatel	296
CUSCO , Scheidenspekula	435
CUSHING , Flachbohrer	228
Hirnspatel	274
Laminektomiezüngen	276
Nervhaken	270
Pinzetten	57, 61
Wundhaken	113
CUZZI , Abortuslöffel	469
Cystotom	293
CZERNY , Rektalspekulum	428

D

DANDY , Arterienklemme	79
Nervhaken	270
Neurochirurgische Schere	37
DARLING , Wundsperrerr	131
Darm, -klemmen	408-416
-scheren	39
DARTIGUES , Uteruszange	448
DASTOOR , Kapselsauger	298
Strabismuspinzetten	304
DAVIDSON , Scapula-Wundhaken	126
DAVIEL , Startlöffel	294
DAVIS , Dissektor	273
Fremdkörpernadel	290
Sterilisierzangen	177
DAVIS-BOYLE , Mundsperrerr	367
DAY , Ohrhäkchen	325
DEAN , Irismesser	287
Tonsillenscheren	31
DEAVER , Feine chirurgische Scheren	25, 44
Wundhaken	109-110
DE BAKY , Atrauma Pinzetten	66
Bulldog Atrauma Klemmen	68
Gefäßscheren	32-33
Nadelhalter	160
DEJERINE , Hämmer	6
DE LEE , Geburtszangen	464
DE MARTEL , Kopfschwartenzange	80
Umführungsinstrument	272
DE MARTEL-WOLFSON , Anastomosenklemmen	414
Klemmenhalter	414
Klemmenschießzange	414
DENHART , Mundsperrerr	366
Depressoren, Uterus	449

Inhaltsverzeichnis

DERF , Nadelhalter	152, 159
Dermatom	22
DESCHAMPS , Unterbindungsnadeln	166
DESJARDINS , Gallenkanal-Klemmzangen	92
Gallensteinlöffel	403
Gallensteinsonde	403
Gallensteinzangen	402
DESMARRES , Chalazionspinzetten	312
Lidhalter	113
DEUTSCHMANN , Starmesser	286
DE VILBISS , Schädelzange	271
DEWEY , Geburtszange	466
Diagnostik Sätze	3, 11-13
Diamant Drahtschneider	237
DIEFFENBACH , Gefäßklemmen	69
DIETER , Hammerkopfstanze	330
DIETRICH , Nadelhalter	164
Dilatoren, Harnröhren-	425
Tracheal-	386
Tränenkanal-	299
Uterus-	442-444
DINGMANN , Knochenhaltezeuge	197
Dissektoren,	272-273
Hornhaut-	288, 291
Tonsillen-	372
Tränensack-	295
DIX , Fremdkörpermeißel	291, 298
DOUGLAS , Cilienpinzette	315
Trokar	147
DOYEN , Bauchdeckenhaken	122
Darmklemmen	410
Fräser	231
Gynäkologische Schere	34
Hohlsonde	141
Kugelfräser	231
Myomheber	457
Raspatorien	213
Scheidenspekula	440
Tuchklemme	99
Uteruspolypenzange	448
DOYEN-JANSEN , Mundsperrerr	366
Draht	236, 326, 375
-schlingen	295, 326, 375
-schneide- und Biegezeugen	236
-scheren, Universal	41, 49
-spanner	236
DUBOIS , Gynäkologische Schere	35
DUPLAY , Hakenzange	445
DUPLEX , Stethoskop	5
DUPUY-WEISS , Tonsillennadel	373
-Dissektoren	272-273
DUVAL , Fasspinzette	62
DUVAL-COLLIN , Fasspinzette	62
Fasszangen	409
Dynamometer	3

E

ECHLIN , Hohlmeißelzange	187
Ein/Ausschläger für Marknägel	239
Einmalskalpelle	17
Elektrische Gipssäge	182
Elevatoren, Perioist-	213-214, 352
Septum-	352
Tonsillen-	372
ELLIOT , Geburtszangen	464
Trephinen	314
ELLIS , Fremdkörperhohlmeißel	291
ELSCHNIG , Cyclodialysespatel	297
Fixierpinzette	307
Hornhautmesser	288
Kapselpinzetten	308-309
EMMET , Fistelhaken	457
Endarterektomiestripper	142
ENGEL , Gipssäge	180
Erukleationsscheren	30
EPPENDORFER , Biopsiestanzen	455-456
ESMARCH , Gipsmesser	181
Verbandscheren	42
EVES , Tonsillenschnürer	375
Extensionsbügel	235
Extraktionshaken	239, 292
Extractor, für Marknägel	239

F

FARABEUF , Knochenhaltezeugen	192
Raspatorien	212
Wundhaken	106
FARABEUF-LAMBOTTE , Knochenhaltezeuge	192
FARREL , Watteträger	143
FAULKNER , Küretten	360
FAURE , Peritoneumklemmen	95
Uterusbiopsiezange	451
FEHLAND , Darmklemmen	413
FEILCHENFELD , Splitterpinzetten	64
Feilen, Knochen-	222
Nagel-	473
FERGUSON , Druckklemmen	79
Gallensteinlöffel	403
FERGUSSON , Knochenhaltezeugen	192
FERRIS-SMITH , Laminektomiezeugen	277
Pinzetten	60
FERRIS-SMITH-KERRISON , Laminektomiestanzen	278
Finger, -nagelbohrer	226
-platten	263
-ringsäge	226
-schützer	369
-verbandschere	42
FINOCHIETTO , Bronchusklemme	398
Nadelhalter	155, 162
Rippensperrerr	392-393
FINOCHIETTO-BURFORD , Rippensperrerr	393-394
FINSEN , Wundsperrerr	127
FISCH , Dissektoren	337
FISCHER , Irispinzette	302
Flachbohrer	228
Flachmeißel	203-209
Flachzangen	236
FLEURANT , Blasenstichtrokar	147
FOERSTER , Irispinzetten	301
Schwammzangen	101
FOMON , Choanenhaken	358
Meißel	354
Nasenflügelhaken	358
Nasenraspeln	357
Nasenschere	31
FORD , Stethoskop	5
FORD-BOWLES , Stethoskop	5
FOREGGER , Laryngoskope	12
FOX , Lupusküretten	472
FRAENKEL , Kehlkopfpolypenzange	378
Zangenaufsätze	379
Fräser	227-228, 231-232
FRANCESCHETTI , Trephinen	314
FRANCIS , Fremdkörpernadel	290
FRANCKE , Blutschnäpper	3
FRANKLIN-SILVERMANN , Biopsienadel	149
FRAZIER ,	111
Saugkanülen	275
Wundsperrerr	135
FREER , Hohlmeißel	355
Mukosamesser	350
Septumelavatorien	352
Septummeißel	353
Septummesser	350
Fremdkörper, -hebel	327
-meißel	291
-nadeln	290-291
-schlingen und Magnet	315
-zangen	382, 423
FRENZEL , Zungendrucker	364
FRIEDMANN , Hohlmeißelzangen	184
Wundsperrerr	441
FRI TSCH , Wundhaken	121
FRYKHOLM , Hohlmeißelzange	188
FUCHS , Kapselpinzette	309
Führungshohlsonden	169

G

GALLAHER , Antrumraspeln	357
Gastroskopiezangen	382-384
GAUSS , Kopfschwartzange	467
Gefäß, -klemmen	68, 279-281
-scheren	32-33, 48
GELLHORN , Biopsiezange	451

GELPI , Perinealwundsperrler	133
GEMINI (Mixer) , Präparier- und Ligaturklemme	85
GERALD , Pinzetten	57, 61
GERSTER , Distractionsklammer	198
GERZOG , Hammer	210
Gewindebohrer	241
GIERTZ-STILLE , Rippenschere	391
GIGLI , Drahtsägegriff	272
GILL , Hornhautdissektor	288
Irispinzette	302
GILL-ARRUGA , Kapselpinzette	308
GILL-HESS , Irispinzetten	302
GILLIES , Hähchen	358
Nadelhalter mit Schere	157, 163
Pinzette	60
Gips, Abreißzangen	181
Messer	181
Sägen	180
Säge, elektrisch	182
Scheren	180
Spreizer	181
Glasdose, -schale	477
GLOVER , Atrauma Gefäßklemme	68
GLUCK , Rippenschere	390
GOELET , Wundhaken	108
GOLDSTEIN , Lidsperrler	285
GOOD , Tonsillenschere	32
GOODELL , Uterusdilator	444
GOSSET , Bauchdeckenhalter	135
GRADLE , Cilienpinzette	315
GRAEFE , Cystotom	287
Fixierpinzetten	307
Irishähchen	111, 293
Irispinzetten	300
Lidsperrler	284
Pinzetten	62
Schielhaken	292
Skarifikateur	287
Starlöffel	294
Starmesser	286
GRAHAM , Nervhaken	270
GRAVE , Scheidenspekula	434
GRAY , Gallenkanalklemmen	93
GREEN , Fixierpinzetten	308
Hornhautdissektor	291
Muskelhaken	291
GREEN-ARMYTAGE , Uterusklemmzange	467
GREVEN , Drahtbiegezügchen	329
Griffe, für Drahtsägen	272
für Kehlkopfspiegel	380
Skalpell	16
Universal	379
GROSS , Ohrlöffel- und Haken	324
Ohrschlinge und Haken	324
GROSS-MAIER , Tupferzangen	100
GRUBER , Ohrtrichter	318
GUTHRIE , Doppelhähchen	111
GUTMANN , Sekretlöffel	424
GUYON , Dilatationsbougies	425
Katheterspanner	424
Nierenstielklemmen	93
GUYTON-LUNDSGAARD , Sklerotom	289

H

HABERER , Bauchspatel	109
Hähchen	111
Haut	111
Iris	111, 292-293
Knopf	325
Ohr	325, 335-337
Schleimhaut	111
Tracheal	386-387
Hämmer	6, 210-211
HAGLUND-STILLE , Gipsspreizer	181
HAIGHT , Rippensperrler	395
HAJEK-BALLENGER , Septumelevatorium	353
HAJEK-CLAUS , Kieferhöhlenstanze	347
HAJEK-KOFLER , Stanzen	347
Haken, Bauchdecken	122, 124
Choanen	358
Cystikus	431
Dekapitations	470

Extraktions	239, 292
Fistel	457
Gaumensegel	372
Geburts	467
Knie	220
Linsen	292
Muskel	138, 291
Nasenflügel	358
Nasenrücken	359
Nerv	270-271
Nervwurzel	271
Prostata	420
Scapula	126
Schiel	291-292
Schilddrüsen	119, 388
Spinal	220
Wund	113
HALLE	273
Scharfe Löffel	201
HALSEY , Nadelhalter	152, 159
HALSTEAD-MOSQUITO , Arterienklemmen	71
Halter, Bauchdecken	134-137
Lippen- und Wangen	365
Kehldeckel	378
Schädel	269
Scheiden	436-440
Haltezangen, für Knochen	192-197
Knochenplatten	240
Knochenschrauben	240
Handbohrapparate	227-230
Handmotor, elektrisch	230
HANK , Uterusdilatoren	442
HARRINGTON , Bronchusklemmen	398
Wundhaken	109
HARTMANN , Arterienklemmen	70
Nasenpolypenzangen	344
Ohrkatheter	322
Ohrzängchen	326-327
Ohrtrichter	318
Scharfe Nasenzangen	346
Stimmgabeln	329
Zungendrucker	364
HARTMANN-HALLE , Nasenspekula	340
HARTMANN-HOFFMANN , Ohrzängchen	328
HARTMANN-WULLSTEIN , Ohrzängchen	328
HAUGH , Ohrzängchen	329
Hautinstrumente	473-474
HEANEY , Hysterektomieklammern	95
Nadelhalter	154, 161
Wundhaken	124
HEATH , Ligaturschere	39
HEBRA , Chalazionslöffel	294
HEGAR , Uterusdilatoren	442
HEGENBARTH , Wundklammerpinzette	175
HEIFETZ , Spatel	274
HEISS , Arterienklemmen	83
HEISTER , Mundsperrler	366
HENKE , Tonsillenelevatorium	372
HENNIG , Gipsspreizer	181
HERRICK , Nierenstielklemme	94
HESS , Kapselpinzetten	309
Irispinzetten	302
HEYMANN , Nasenschere	31
Nasenzange	345
HEYMANN-KNIGHT , Nasenzange	344
HEYWOOD-SMITH , Fasszange	431
HIBBS , Flachmeißel	208
Hohlmeißel	208
Osteotome	208
HIRSCHMANN , Anuskope	430
HOESEL , Nadelhalter	155
HOFER , Gaumenbogenhaken	372
Hohlmeißel	203-209
Hohlmeißelzangen	184-189
Hohlsonden	140-141
HOHMANN , Knochenhebel	217-220
HOKE , Osteotome	205
HOLTH , Kapselstanze	298
HOPKINS , Gipsmesser	181
HORSLEY , Dissektor	273
HOUSE , Küretten	327
Messsonden	338
HUBER , Universalgriff	379
HUDSON , Bohrwinde	228

Inhaltsverzeichnis

HUNTER , Splitterpinzetten	64
HURD , Tonsillendissektor	372

I

INGE , Wirbelkörperspreizer	275
Instrumentenschalen	477-478
Inzisionsschere	25
IOWA , Hakenzange	447
Nadelführung für Pudendusnästhesie	149
Iris, -Häkchen	111
-Messer	287
-Pinzetten	300-305
-Scheren	29, 47, 52
-Spatel	296
ISRAEL , Wundhaken	120
ITARD , Ohrkatheter	322
ITERSON , Trachealhäkchen	386
IVES-FANSLER , Anuskop	430

J

JACKSON , Tamponpinzetten	378
Trachealhäkchen	386
Trachealkanülen	387
Scheidenspekula	439
Jacobs Dreibackenspannfutter	230
JACOBS , Hakenzangen	447
JAEGER , Lanzenmesser	286
Lidplatte	285
JAMESON , Schielhaken	291
Strabismuspinzetten	303
JAMISON , Nadelhalter	153, 161
JANSEN , Nasenpinzette	343
Wundsperrerr	127
JARCHO , Hakenzange	446
JATHO , Nasenrachenzange	359
JENNINGS , Mundsperrerr	366
JEWETT , Knochennägel	251
JOBSON-HORNE , Watteträger	143
JOHNS-HOPKINS , Arterienklemme	91
Gefäßklemmen	69
JOHNSON , Nadelhalter	155
JONES , Tuchklemmen	98
JOSEPH , Knochenfeilen	356
Nasenplastikmesser	350
Nasenraspeln	356, 358
Nasenscheren	29
Periostelevatorium	353
Schleimhauthäkchen	111
JUDD-ALLIS , Gewebezangen	408
JUDD-MASSON , Blasenspreizer	421
JUERS , Drahtbiegezügchen	329
JURASZ , Kehlkopfpolypenzangen	378

K

KABIERSKE , Pulverbläser	321
KALLMORGEN , Scheidenhalter	439
Scheidenspekula	439
KALT , Kapselpinzette	308
Nadelhalter	158
KALT-ARRUGA , Nadelhalter	158
KANE , Nabelschnurklemme	467
Kanülen, Augen-	313
für Lumbalpunktion	148
für Pudendusnästhesie	149
Luft-	313
Kieferhöhlen-	349
Knopf-	313
Saug-	275, 431
Spül-	313, 349
Tonsillen-	376
Tracheal-	387
Kapselsauger	298
-stanze	298
Katheter, Einführzangen	10
Metall-	426
Ohr-	322
Prostata-	426
KAUPP , Wundspreizer	127
Kehlkopfspiegel	380
KEITH , Nähnadeln	173

KELLY , Arterienklemmen	72
Fistelschere	36
Proktoskope	430
Uteruspolypenzange	448
Wundhaken	107, 124
KELLY-RANKIN , Arterienklemmen	72
KERN , Knochenhalte-zangen	193
KERRISON , Stanzen	347
KEVORKIAN , Biopsieküretten	450
Biopsiezange	452
KEVORKIAN-PACIFIC , Biopsiestanze	453
KEY , Elevatorium	215
KEYES , Hautstanzen	473
KIELLAND , Geburtszange	465
KIELLAND-LUIKART , Geburtszange	465
KILLIAN , Nasenspekula	341
Septumlevatorium	352
Spülkanüle	349
KILLIAN-CLAUS , Hohlmeißel	355
KILNER , Plastische Scheren	29, 47
Hauthäkchen	472
KILNER-DOUGHTY , Mundsperrerr	367
KIRBY-ARTHUR , Irispinzette	304
KIRK , Hammer	210
KIRSCHNER , Bauchdeckenhalter	137
Bohrapparate	229
Bohrdrahtstützen	229
Draht	234
Extensionsbügel	235
Führungshohlsonde	169
Klammer, Distractions-	198
Klemmen, Anastomosen-	400, 414
Arterien-	67-96
Bronchus-	87-88, 398-399
Bulldog Atrauma-	68-69
Darm-	408-414
Darm-atraumatisch	408-413
Darmquetsch-	416
Gallenkanal-	92-93, 402
Gefäß-	68-69
Hysterektomie-	94-95
Ligatur-	84-86
Magen-	414-415
Muskel-	388
Nabelschnur-	467
Nierenstiel-	92-94
Penis-	423
Präparier-	84-86
Peritoneum-	94-95
Schlauch-	96
Schließ-	414
Thorax-	86
Tonsillen-	373
Tuch-	98-99
Ureter-	406
Klemmenhalter	414
Klemmzange	414
Klingen, Einmal-	17
Klingenbrecher	18
KLINKENBERGH-LOTH , Thoraxschere	38
KNAPP , Häkchen	293
Irismesser	287
Starlöffel	295
KNAPP-LUER , Trachompinzette	312
KNIGHT , Scharfe Nasenzange	345
Knochen, -draht	236
-feilen	222
-halte-zangen	192-197
-hebel	216-220
-meißel	203-209
-nägel	244-251
-platten	251-265
-raspel	222
-schrauben	253-258, 264
-splitterzangen	190-191
KNOWLES , Verbandschere	42
KOCHER , Arterienklemmen	78
Blasenspatel	422
Darmklemmen	411
Kropfsonden	388
Wundhaken	118-119, 122
KOENIG , Führungshohlsonden	169
Nähnadeln	172
KOERTE , Wundhaken	121

KOGAN , Endospekulum	441
Kompressionsplatten	252
-schrauben	253
Komprimeter	224
Kondylenplatten	261
KONRICH , Sterilisiertrommeln	479
Kontraktoren, Rippen-	396
Kopfhautklammern	269
Kornzangen	100
Kortikalisschrauben	257
Kranioklaste	470
KRAUSE , Nasenpolypenschnürer	349
Ohrpolypenschnürer	326
Zangenaufsätze	379
Kreissägen	233
KRISTELLER , Scheidenhalter	436-438
Scheidenspekula	436-438
KRONECKER , Unterbindungsnadeln	167
KUENTSCHER , Aufreiber Femur	238-239
Extraktor	238-239
Fertigschläger	238-239
Knochennägel	245-248
Marknägel	245-249
Vorbohrer	238-239
Vorschlaginstrumente	238-239
Küretten, Abortus-	469
Antrum-	360
Fremdkörper-	291
Lupus-	472
Ohr-	323, 327
Saug-	450
Uterus-	458-461
KUHNT , Hornhautschaber	289

L

LABORDE , Trachealdilatator	386
Lärmtrommel	321
LA FORCE , Adenotom	362
Fremdkörperinstrument	291
LAHEY , Gallenkanalklemmen	91
Kropfzangen	388
Wundhaken	114
LAMBERT , Chalazionspinzette	312
LAMBOTTE , Knochenhaltezeugen	192-193
Osteotome	206
Raspatorien	212
Laminektomiezeugen	276-278
LANCASTER , Lidsperrerr	285
LANDAU , Scheidenspekula	441
LANE , Biegehebel für Knochenplatten	240
Haltezeuge für Knochenplatten	240
Haltezeuge für Knochenschrauben	240
Knochenhaltezeugen	194
Magenklemmen	415
Pinzetten	60
Schraubendreher	240
Tuchklemme	99
LANG , Tränenacklöffel	295
LANGE , Zangenaufsatz	379
LANGENBECK , Elevatorium	214
Fingersäge	225
Fingerschützer	369
Knochenhaltezeuge	192
Raspatorien	212, 214
Resektionsmesser	21
Wundhaken	116-117
Laryngoskope	11
LAWRENCE , Arterienklemme	89
LEBSCHKE , Sternummeißel	208
LEGUEU , Blasenpatel	422
Blasenspreizer	421
LEKSELL , Hohlmeißelzangen	189
LEMPERT , Elevatorium	338
Hohlmeißelzangen	186
Scharfe Löffel	201
LERCHE , Fasspinzette	62
LERICHE , Arterienklemmen	82
LESTER , Fixierpinzette	307
LEVINSON , Fremdkörpernadel	290
LEWIN , Knochenhaltezeuge	196
LEWIS , Nasenraspeln	356
LEXER , Flachmeißel	205-206
Hohlmeißel	205-206

Chirurgische Scheren	26, 45
LEXER-BABY , Chirurgische Scheren	27, 45
LICHTWITZ , Kieferhöhlenkanüle	349
Lidsperrerr	284-285
Ligaturschere	39
Lippen- und Wangenhalter	365
LISTER , Tupferzange	102
Verbandschere	41, 49
LISTER-BURCH , Lidsperrerr	276
LISTON , Amputationsmesser	20
Knochensplitterzangen	190
LISTON-KEY-HORSLEY , Knochensplitterzange	191
LITTAUER , Cilienpinzette	315
Ligaturschere	39
Nasenpolypenzange	344
Ohrzängchen	326
LITTLE , Wundhaken	114
LLOYD , Vorschläger/Nagelzieher	240
Löffel, Abortus-	469
Chalazions-	293-295
Enukleations-	296
Exenterations-	294
Gallenstein-	403
Geburts-	467
Sekret-	424
Star-	293-295
Tränensack-	295
LORENZ , Verbandschere	42
LORNA , Tuchklemmen	99
LOUTE , Drahtspanner	236
LOVE , Nasenrachenraumretraktor	372
Nervwurzelhaken	271
LOVE-GRUENWALD , Laminektomiezeugen	276
LOVELACE , Arterienklemme	80
Lungenzangen	397
LOWER , Gallenkanalklemme	91
LOWMAN , Knochenhalteklammern	198
LUBET-BARBON , Nasenpolypenzange	344
LUC , Scharfe Nasenzangen	345
LUCAE , Hammer	210
Ohrpinzetten	325
Stimmgabeln	321
LUER , Hohlmeißelzangen	185
Trachealkanülen	387
LUIKART , Geburtszange	465
LUIKART-BILL , Zughebel	467
Lumbalpunktionskanülen	148
LUNDGAARD , Sklerotom	288
LUNIATSCHKEK , Tamponstopfer	372
LURZ , Ureterklemmen	406

M

MAGILL , Kathetereinführungszangen	10
MAISONNEUVE , Urethrotom	423
Malleolarschrauben	257-258
MALTZ , Nasenraspel	356
Markierinstrumente	298
Marknägel	244
MARSCHIK , Tonsillenpinzette	374
MARTIN , Beckenzirkel	468
Knorpelzange	197
Uterussonden	449
MARTINI , Scharfe Löffel	202
MASSON , Nadelhalter	154, 162
Maßstäbe	7
MASTIN , Muskelklemme	388
MATHIEU , Fremdkörperzangen	423
Nadelhalter	156, 163
Rektalspekulum	428
Wundhaken	106
MATSON , Raspatorium	214
MATSON-ALEXANDER , Raspatorium	214
MAUNDER , Mundkeil	369
MAYO , Gallensteinlöffel	403
Nierensteinsonde	406
Scheren	26, 44
Sterilisierklammer	178
MAYO-BLAKE , Gallensteinzangen	402
MAYO-GUYON , Nierenstielklemme	92
MAYO-HEGAR , Nadelhalter	153, 160
MAYO-NOBLE , Scheren	27
MAYO-ROBSON , Darmklemmen	412
MAYO-STILLE , Scheren	26, 45

Inhaltsverzeichnis

McCULLOUGH , Strabismuspinzetten	303
McDONALD , Doppellevatorium	215
McGEE , Häkchen	336
Drahtbiegezüngchen	329
McGUIRE , Hornhautschere	52
McINDOE , Knorpelschere	37
Pinzette	56
McINTOSH , Laryngoskope	11
McIVOR , Mundsperrerr	367
McKENTY , Septumlevatorium	352
McKENZIE , Bohrer	228
Clip-Anlegezangen	268
McLAUGHLIN , Knochenplatten	251
McLEAN , Geburtszange	465
McLEAN-LUIKART , Geburtszangen	465
McLEAN-TUCKER , Geburtszange	465
McLEAN-TUCKER-LUIKART , Geburtszange	465
McPHERSON , Fadenpinzetten	311
MEAD , Hammer	211
Hohlmeißelzangen	184
MEEKER , Arterienklemme	89
Meißel, Blutstillungs-	338
Extirpations-	291
Fremdkörper-	291
Knochen-	203-209
Nasen-	351
Nasenplastik-	350
Septum-	353
Sternum-	208
Wirbelsäulen-	209
MELLINGER , Lidsperrerr	285
MELLINGER-AXENFELD , Lidsperrerr	284
MENGHINI , Punktionskanülen	148
Meniskotome	221
MERCEDES , Thoraxwundspreizer	396
Messer, Amputations-	20
Diszisions-	287-288, 290
Dissektoren	273
Gips-	181
Goniotomie-	289
Kopf-	21
Hornhaut-	288
Iris-	287
Kapsulotomie-	288
Keratoplastik-	289-290
Knorpel-	21
Lanzen-	286
Lappen-	335
Meniskus-	221
Mucosa-	350
Myom-	457
Nasen-	350
Ohr-	323-324, 335
Operations-	19-20
Periostal-	338
Rund-	335
Resektions-	21
Septum-	351
Star-	286
Meßbecher, graduiert	478
Messzirkel	7
METZENBAUM , Nadelhalter	154
Scheren	27-28, 46-47
METZENBAUM-FINO , Scheren	28, 46
MEYERDING , Wundhaken	114
MEYHOEFER , Chalazionslöffel	293
MICHEL , Postrhinoskopiepiegel	343
Wundklammern	176
Wundklammeranlegezange	175
Wundklammerpinzette	175
Micro, -pinzetten	64, 66
-scheren	51-54, 328, 330-331
-zängchen	328-330, 332-334
MIDDELDORPF , Wundhaken	119
MIDDLETON-JANSEN , Scharfe Nasenzangen	348
MIKULICZ , Peritoneumklemme	95
Wundhaken	123
MILLIGAN , Dissektor	272
MILLIN , Blasenhalsspreizer	421
Fadenführungszange	421
Zange vordere Prostatalappen	421
Kapsel-fasszangen	420
Mini, Clips Aneurysma	279

Clipanlegezange	281
Fragmentplatten	264
Schrauben	255
MIXTER , Arterienklemmen	89-90
Gallensteinzange	402
Gallenkanalklemme	92, 402
MIXTER-BABY , Arterienklemmen	90
MIXTER-O'SHAUGNESSY , Arterienklemmen	90
MOD. BERLIN , Schlauchklemme	96
MOD. WIEN , Nasenspekulum	341
MOELTGEN , Winkelmesser	7
MOLLISON , Wundsperrerr	131
MOORE , Bohrapparat	228
Gallensteinlöffel	402
MOORFIELD , Nahtpinzette	310
MOYNIHAN , Gallensteinsonde	403
Klemmzange	92
Tuchklemme	99
MUCK , Periostmesser	338
MUELLER , Lidsperrerr	285
Mundsperrerr	366-368
MURDOCK , Lidsperrerr	284
MURPHY-LANE , Knochenhebel	216
MUSEUX , Hakenzangen	446
Muskelhaken	138, 291
MYLES , Scharfe Nasenzangen	346
Myom, -heber	457
-messer	457
Myrtenblattsonden	140

N

NABATOFF , Varizen-Besteck	141
Nabelschnurscheren	35
Nadeldosen	476
Nadelhalter	151-164
Nadeln, Diszissions-	290
Fremdkörper-	290
Injektions-	149, 313
Leberpunktions-	148
Näh-	170-174
Paracentese-	323
Pneumoperitoneum-	149
Star-	290
Tonsillen-	373
Unterbindungs-	165-168
Nadelrad	7
NAEGELE , Geburtszangen	464
Nägel, Knochen-	244-250
Nähnadeln	170-174
Nagel, -feilen	473
-hautzangen	474
-scheren	473-474
-zangen	474
NAGER , Gaumensegelhaken	372
Nasen, raspeln	356-357
-sägen	358
-scheren	29, 31-32
-spekula	340-342
-zangen	344, 359
NEFF , Meniskotome	221
NEGUS , Tonsillenklemmen	373
NEIVERT , Nadelhalter	152
NELSON , Fasspinzette	63
Trokare	147
Unterbindungs-nadel	167
Neurochirurgie	268-274, 279-281
Nerv, -haken	270-271
-präparierscheren	37
Nierenschalen	478
Nierenstillklemmen	92-94
NORTHBENT , Ligaturschere	39
NOTO , Uteruspolypenzange	448
NOVAK , Saugküretten	450
NOYES , Irisschere	52
Nasenpolypenzangen	344

O

O'CONNOR , Irishäkchen	292
O'SULLIVAN-O'CONNOR , Bauchdeckenhalter	135
OCHSNER , Gallensteinsonde	403
Trokare	148
Ohr, -katheter	322

-küretten	323
-messer	323-324
-pinzetten	325
-polypenschnürer	326
-schlingen	324
-sonde	141
-spritzen	322
-trichter	318-319
-zängchen	326
OLDBERG , Laminektomiezange	277
OLIVECRONA , Drahtsägen	272
Spatel	274
Hohlmeißelzange	185
OLIVECRONA-TOENNIS , Clipanlagezange	268
OLLIER , Wundhaken	120
OLSEN-HEGAR , Nadelhalter	156-157, 163
Ophthalmoskope	3
Osteotome	203-209
Osteosynthese	240-241
Otoskopbesteck	3
OVERHOLT , Doppelraspatorien	214
OVERHOLT-GEISSENDOERFER , Präparierklemmen	84

P

Parametriumscheren	34
PARHAM , Band/Bandspanner	198
PARK , Lidsperrerr	285
PARKER , Skalpell	20
Wundhaken	106
PARKER-LANGENBECK , Wundhaken	106
PARTSCH , Flachmeißel	204
Hohlmeißel	204
PASSOW , Blutstillungsmeißel	338
PATON , Hornhautdissektor	288
PAUFIQUE , Fadenpinzetten	311
Keratoplastikmesser	289
PAYR , Magenquetschklemmen	416
Führungshohlsonde	169
PEAN , Arterienklemmen	73, 80
PEDERSON , Scheidenspekula	434
PEET , Splitterzängchen	65
PELKMANN , Tupferzange	102
PENFIELD , Dissektoren	273
PENNINGTON , Arterienklemme	80
PERCY , Amputationsretraktor	224
Perforatorium	470
PERTHES , Pfriem	232
PESTALOZZA , Abortuskürette	469
Pflasterpastel	141
Pfrieme	232
PHANEUF , Peritoneumklemmen	94
PIERCE , Antrumtrokare	146
PIFFARD , Lupusküretten	472
PINARD , Stethoskop	5
Pinzetten, anatomisch	56-58
Atrauma-	66
Chalazions-	312
chirurgisch	59-61
Cilien-	315
Entropium-	312
Faden-	310-311
Fass-	62-63
Fixier-	307-308
Gefäß-	58, 61
Hartmetall-	58, 305-306, 310-311, 409
Hypophysen-	274
Iris-	300-305
Kapsel-	308-309
Mikro-	64, 66
Muskel-	306
Naht-	310-311
Nasen-	343
Splitter-	64
Strabismus-	303-304
Tampoon-	378
Tonsillen-	374
Trachom-	312
Uhrmacher-	64
Vorderkammer-	306
Wundklammer-	175
PIPER , Geburtszangen	466
PITHA , Mundkeil	369
Platten, Knochen-	251-265

PLESTER , Lappenmesser	325
Wundsperrerr	128
POLITZER , Luftdusche	322
Paracentesenadeln	323
POOLE , Saugrohre	10
POTTS-DE MARTEL , Gefäßscheren	33
POTTS-SMITH , Gefäßpinzetten	57-58, 61
Gefäßscheren	33, 48
Präparierklemmen	84-86
Präparierscheren	29, 34, 36
PRATT , Arterienklemme	80
Cystikushaken	431
Hakenzange	447
Rektalspekulum	428
PRESBYTERIAN-HOSPITAL , Schlauchklemme	96
PRICE-THOMAS , Bronchusklemmen	398
PRINCE , Muskelpinzetten	306
Tonsillenscherere	32
Proktoskope	430
PROVIDENCE-HOSPITAL , Arterienklemmen	73
Pulverbläser	321
PUTTI , Knochenraspel	222

Q

QUINBY , Zahnfleischschere	40
QUINKE , Pneumoperitoneumnadeln	149
QUIRE , Fremdkörperhebel	327
QUISLING , Intranasalhammer	211

R

RADOLF , Nagelausreißzange	226
RALK , Bohrapparat	230
Splitterzange	65
RAMPLEY , Schwammzange	101
RANDALL , Nierensteinzangen	405
Saugkürette	450
RANEY , Klammeranlage- und Abnahmezange	269
Kopfhautklammern	269
Raspatorien	212-215
Raspeln, Antrum-	357
Knochen-	222
Nasen-	356-357
RECAMIER , Uterusküretten	460
REICHERT , Kehledeckelhalter	378
REINER , Gipsmesser	181
Ohrspritzen	322
REVERDIN , Bauchspatel	109
Unterbindungsadeln	168
REYNOLDS , Präparierscheren	29, 47
Rhachiotom	209
RICHARDSON , Wundhaken	107
RICHARDSON-EASTMAN , Wundhaken	107
RICHTER-HEATH , Wundklammernzange	175
RIGBY , Wundsperrerr	133
Ringmesser	360-362, 376
Rippen-, -konraktoren	396
-raspatorien	213
-scheren	390-391
-sperrerr	392-396
ROBERTS , Arterienklemmen	87
ROCHESTER-CARMALT , Arterienklemmen	78
ROCHESTER-OCHSNER , Arterienklemmen	76
ROCHESTER-PEAN , Arterienklemmen	74
ROEDER , Tuchklemme	98
ROGER , Septumlevatorium	352
ROGGE , Sterilisierzange	177
ROLLET , Extirpationsmeißel	291
Häkchen	292
ROSE , Trachealhäkchen	387
ROSEN , Rundmesser	335
Nadeln	336-337
ROSENBERG , Zangenaufsatz	379
ROSER-KOENIG , Mundsperrerr	366
ROUX , Wundhaken	106, 108
ROUX-BABY , Wundhaken	108
ROWE , Repositionszangen	369
RUBIN , Septumquetschzange	347
RUMEL , Thoraxklemmen	86
RUSKIN , Hohlmeißelzangen	186-187
RUSKIN-LISTON , Knochensplitterzangen	190
RUSS. MODELL , Fasspinzetten	62
RYDEL-SEIFFER , Stimmgabeln	321

Inhaltsverzeichnis

RYDER, Nadelhalter 161

S

SAALFELD, Komedonenquetscher 472

SACHS, Dissektoren 272

Nervhaken 271

Sägen, Amputations-

 Draht- 272

 Finger- 225

 Fingerring- 226

 Gips- 180, 182

 Nasen- 358

SAENGER, Plazenta- und Abortuszangen 468

Salpingograph 457

SANVENERO, Scheren 28

SAROT, Bronchusklemmen 87, 399

 Nadelhalter 155, 161

SATINSKY, Anastomosenklemmen 400

 Thoraxschere 38

SATO, Hornhautmesser 288

SATTERLEE, Amputationssäge 225

SAUERBRUCH, Hohlmeißelzangen 189

 Nadeletui 476

 Rippenschere 391

 Wundhaken 125

SAUERBRUCH-FREY, Rippenschere 391

Saugrohre 10

SAWTELL, Tonsillenklemmen 373

SCHAEDEL, Tuchklemme 98

Schädelhalter 269

SCHAMBERG, Komedonenquetscher 472

SCHUDE, Scharfe Löffel 199

SCHEIE, Augenkanülen 313

 Goniotomiemesser 289

SCHHEINMANN, Zangenaufsätze 379

Scheren, Augen-

 chirurgische 24-29, 36-37, 40, 43-44

 Darm- 39

 Draht- 41, 49

 Kopf- 37

 Eukleations- 30

 Episiotomie- 35

 Fistel- 36

 Gefäß- 32-33, 48

 Gips- 180

 Gynäkologische 34-35

 Hartmetall- 43-49

 Haut- 473

 Hornhaut- 30, 52-53

 Inzisions- 25

 Iridektomie- 53

 Iris- 29, 47

 Knorpel- 37

 Ligatur- 39

 Lungen- 37-38

 Mikro- 51-54

 Nabelschnur- 35

 Nagel- 473

 Nasen- 29, 31-32

 Neurochirurgische 36-37

 Ohr- 328, 330-331

 Parametrium- 34

 Plastische Chirurgie- 29

 Präparier- 29, 34, 36

 Rippen- 390-391

 Sehnen- 30

 Strabismus- 30, 47

 Thorax- 37-38

 Tonsillen- 31-32

 Universal- 42, 49

 Uterus- 34

 Verband- 41-42, 49

 Zahnfleisch- 40

SCHIMMELBUSCH, Verbandstofftrommel 479

SCHINK, Dermatome 22

SCHIOETZ, Tonometer 314

Schlauchklemmen 96

Schlingen, Draht-

 Nasen- 349

 Ohr- 324

 Tonsillen- 375

SCHMIEDEN, Führungshohlsonde 169

SCHMIEDEN-PAYR, Führungshohlsonde 169

SCHMIEDEN-TAYLOR, Duraschere 37

SCHNIDT, Tonsillenklemmen 373

Schnürer, Nasenpolypen-

 Ohrpolypen- 326

 Rektalpolypen- 431

 Tonsillen- 375

SCHOENBORN, Schilddrüsenhaken 388

SCHOENBURG, Darmzange 410

Schrauben, Knochen- 253-258, 264

Schraubenzieher 240

SCHROEDER, Hakenzangen 445-446

SCHUBERT, Biopsiezangen 451

SCHUKNECHT, Rollmesser 335

 Sichelmesser 335

SCHULTZE, Salpingograph 457

SCHUMACHER, Biopsiezange 452

 Nabelschnurschere 35

 Zangenaufsatz 379

SCHWEIGER, Kapselpinzetten 309

Schwingmesser 351

SEDILLOT, Raspatorium 212

SEEMANN-SEIFFERT, Mundsperrer 366

SEGOND, Myommesser 457

 Sehnenstripper 222

SEIFFERT, Zangenaufsatz 379

SELLHEIM, Geburtslöffel 467

SEMB, Bronchusklemmen 399

 Hohlmeißelzange 188

 Knochenhaltezange 192

 Knochensplitterzange 190

 Raspatorium 213

SEMKEN, Pinzetten 56, 60

SEMM, Scheidenspekula 436

SENN, Wundhaken 108

SENN-GREEN, Wundhaken 114

Sequesterzangen 196-197

SEXTON, Ohrmesser 324

SHEA, Mikroschere 328

SHERMANN, Knochenplatten 265

 Knochenschrauben 264

Sichelmesser 335

SIEBOLD, Gynäkologische Schere 34

Siebschalen 480

SIEGLE, Ohrspekulum pneumatisch 319

SILVER, Nasenplastikmeißel 354

SIMCOE, Nahtkanüle 313

SIMON, Bauchdeckenhaken 124

 Scharfe Löffel 458

SIMPSON, Geburtszange 464

SIMPSON-BRAUN, Geburtszange 464

SIMPSON-LUIKART, Geburtszange 465

SIMS, Uterusküretten 459

 Rektalspekulum 428

 Scheidenspekula 428

 Uterusdepressor 449

 Uterusdilator 444

 Uterusschere 34

 Uterussonden 449

SINGLEY, Fasspinzette 63

Skalpellingklänge steril 17

Skalpellingriffe 16

SKENE, Hakenzange 445

SLUDER-BALLENGER, Tonsilotom 376

SMELLIE, Geburtshaken 467

 Perforatorium 470

SMILLIE, Meniskotome 221

SMITH, Lidsperrer 284

SMITH-BUIE, Rektumspreizer 429

SMITH-PETERSEN, Hohlmeißel 207

 Knochennägel 250

 Knochenplatten 251

 Osteotome 207

SMITH-US ARMY, Gazescheren 41

SMITHWICK, Clipanlegezangen 268

 Nervhaken 271

SNELLEN, Drahtschlingen 295

 Entropiumpinzetten 312

SOMER, Uteruszange 448

Sonden, Gallenstein-

 Hohl- 403-404

 Hohl- 140-141

 Knopf- 140

 Kropf- 388

 Myrtenblatt- 140

D

Nierenstein-	406
Ohr-	141
Tränenkanal-	299
Uterus-	449
Spannfutter für Handmotor	230
Spatel, Bauch-	109
Blasen-	422
Cyclodialysen-	296-297
Hirn-	274
Iris-	296
Laryngoskop-	11-12
Lungen-	397
Mund-	364
Zungen-	364
Spekula, Nasen-	340-342
Ohr-	318-319
Rektal-	428-429
Scheiden-	434-441
SPENCER , Ligaturscheren	39
SPENCER-WELLS , Arterienklemmen	78
Sperrelevatoren	284-285
Spiegel, Kehlkopf-	380
Postrhinoskopie-	343
Stirn-	4
Spiralbohrer	227-228, 231
Splitterpinzetten	64
Splitterzangen	65
Spongiosaschrauben	258
SPRATT , Scharfe Löffel	200
Spritzen	149, 322, 376
SPURLING , Laminektomie-zangen	276
ST. MARTIN , Nahtpinzette	310
STACKE , Ohrsonde	141
Stanzen, Biopsie-	347-348, 453-456
Hammerkopf	330
Haut-	473
Kapsel-	298
Kieferhöhlen-	347
Starmesser	286
Starnadeln	290
STAUDE-MOORE , Hakenzange	445
ST.CLAIR-THOMSON , Ringmesser	361
STEINMANN , Knochen-nagel	234
Sterilisier-, -behälter	477, 479
-klammer	178
-zangen	177
STERNBERG , Lippenhalter	365
Stethoskope	5
STEVENS , Irispinzetten	301
Linsenhaken	292
Nadelhalter	157
Sehnenscheren	30
STEVENSON , Lidsperrer	285
STIEGLITZ , Splitterzange	65
STILLE , Bohraparat	227
Flachmeißel	205
Gipsscheren	180
Hohlmeißel	205
Nierenstielklemme	92
Osteotome	205
Pinzetten	56, 60
Rippenschiere	390
STILLE-LISTON , Knochensplitterzangen	191
STILLE-LUER , Hohlmeißelzangen	187-188
STILLE-RUSKIN , Hohlmeißelzange	187
STILLE-SHERMANN , Bohraparat	227
Stimmgabeln	320-321
Stirnband	4
-lampen	4
-spiegel	4
STOCKMANN , Penisklemme	423
STONE , Verschlussklemme	414
STONE-WATT , Darmklemmen	414
Schloss	414
Strabismusscheren	30, 47
STRATTE , Nadelhalter	155, 161
STRAUSS , Penisklemme	423
Rektoskop	429
Stripper, Gefäß-	142
Venen-	141
STRUEMPEL , Ohrzängchen	328
STRULLY , Neurochirurgische Schere	36
STRUYCKEN , Nasenzangen	346
SWEET , Clipanlagezangen	268

T

TABB , Sichelmesser	335
TARNIER , Geburtszange	466
Kranioklast	470
TAYLOR , Hämmer	6
Spinalhaken	220
TEALE , Hakenzange	447
TERSON , Kapselpinzette	308
THOMS-ALLIS , Gewebebezangen	408
THOMS-GAYLOR , Biopsiezange	451
THOMSON-WALKER , Blasen spreizer	422
THOREK , Thoraxscheren	37
THÜDICHUM , Nasenspekula	340
TIECK-HALLE , Nasenspekula	341
TILLEY , Ohrzängchen	326
TISCHLER-MORGAN , Biopsiezange	453
TISCHLER-KEVORKIAN , Biopsiezange	455
TIVNEN , Tonsillenfasszange	374
TOBOLD , Zungendrucker	364
TOENNIS , Arterienklemmen	86
Dissektor	272
Nadelhalter	156, 164
TOENNIS-ADSON , Neurochirurgische Scheren	37
Tonometer	314
Tonsillen-, -fasszangen	374
-kanülen	376
-kompressorium	375
-pinzetten	374
-scheren	31-32
-schlingen	375
-schnürer	375
-spritzen	376
Tonsillotom	376
TOOK , Hornhautmesser	288
TOTI , Fräser	232
TOWNSEND , Biopsiestanzen	453-454
TOWNSEND-KEVORKIAN , Biopsiestanze	454
TOYNBEE , Ohrtrichter	318
Tracheotomiebesteck	388
TRAUBE , Hammer	6
TRELAT , Scheidenspekula	436
Trephinen	314
TROELTSCH , Nasenpinzetten	343
TROEMNER , Hammer	6
Trokare, Antrum-	146-147
Bauchstich-	146
Blasenstich-	147
Bruststich-	148
Kieferhöhlen-	147
Tracheotomie-	386
Universal-	146
Trommeln, Sterilisier-	479
Verbandstoff-	479
TROUSSEAU , Trachealdilatator	386
TROUTMANN , Colibri Irispinzette	302
Irispinzetten	305
Klingenbrecher	18
Tuchklemmen	98-99
TÜBINGEN , Fadenpinzetten	310
Irispinzetten	305
Luftkanülen	313
TUFFIER , Arterienklemme	81
Rippenspreizer	395
Tupferzangen	100
TURNBULL , Nagelzange	474
TURREL , Rektumbiopsiezangen	432
TYDING , Tonsillenschnürer	375
Tonsillenfasszange	374

U

UCKERMANN , Trokar	386
Watteträger	143
ULRICH , Tupferzangen	100
Uhrmacherpinzetten	64
Unterbindungsnadeln	166-168
Universal, Diagnostikbesteck	3
Drahtscheren	41, 49
Griff	379
Sterilisierzange	177
Trokare	147
Verbandscheren	42, 49

Inhaltsverzeichnis

UNNA , Komedonenquetscher	472
Urethrotom	425
US-ARMY , Wundhaken	106
USA-MODELL , Gipsspreizer	181
Nabelschnurschere	35
Pinzetten	56, 59

V

VAN BUREN , Harnröhrenbougies	425
Sequesterzange	197
VAN DOREN , Biopsiezange	451
VANNAS , Iridektomieschere	53
Verbandscheren	41-42, 49
VERBRUGGE , Knochenhaltezange	196
VERRES , Pneumoperitoneumnadel	148
VIENNA , Nasenspekula	341
VIRCHOW , Knorpelmesser	21
Schädelspalter	209
VOLKMANN , Scharfe Löffel	199, 202
Wundhaken	115
VOLTOLINI , Nasenspekula	340
VON PETZ , Magen- und Darmnähapparat	417
Vorbohrer	238, 269
Vorschläger	238, 240

W

WACHENFELDT , Wundklammern	176
Wundklammerpinzette	175
WADSWORTH-TODD , Kauter	296
WAGENER , Knopfhäkchen	325
WAGENER-MOSHER , Intubationskanülen	387
WAGNER , Laminektomiezange	277
Zahnfleischscheren	40
WALLICH , Abortuslöffel	469
WALSHAM , Septumrichtzangen	359
WALTON , Fremdkörpermeißel	291
Komedonenquetscher	472
Verbandschere	42
WANGENSTEEN , Fassspinzette	63
Nadelhalter	154, 162
WARTENBERG , Nadelrad	7
WATSON-CHEINE , Doppelevatorium	215
Watteträger	143
WEBER , Drahtschlingen	295
WECKER , Irisscheren	52
Irisspatel	296
WEEK , Lidsperrer	284
WEIL-BLAKESLEY , Biopsiezangen	346
WEITLANER , Wundsperrer	127-128
WEITLANER-WULLSTEIN , Wundsperrer	128
WELLS , Eukleationslöffel	296
WERTHEIM , Hysterektomieklappen	94-95
Präparierscheren	34
WERTHEIM-CULLEN , Hysterektomieklappen	94
WEST , Nasenmeißel	355
WESTCOTT , Iridektomiescheren	52
Sehnschere	52
WESTON , Rektalpolypenschnürer	431
WHEELER , Cyclodialysespatel	297
Diszissionsmesser	288
WHITE , Tonsillenfasszange	374
WHITEHEAD , Mundsperrer	367
WIEDER , Zungendrucker	364
WIENER , Nasenraspeln	356
Irishäkchen	292
WIGMORE , Gipssäge	180
WILDE , Ohrpinzetten	325
Ohrpolypenschnürer	326
Nasenpolypenschnürer	349
WILDER , Drahtschlingen	295
Tränenkanaldilatatoren	299
WILLET-MARTEL , Kopfhautklemme	80
WILLIAMS , Fasszängchen	410
Lidsperrer	285
Schraubendreher	240
WILLIGER , Hammer	210
Raspatorium	212
Scharfe Löffel	202
Winkelmesser	7
Winkelplatten	262
WINTER , Plazenta- und Abortuszangen	468

Stethoskop	5
Wirbelkörperspreizer	275
WITTNER , Biopsiezange	452
WOLFF , Gipsabreißzange	181
WRIGLEY , Geburtszange	464

WULLSTEIN , Sichelmesser	335
Wundhaken	105-138
Wundklammern	176
Wundklammerbesteck	176
Wundsperrer, Blasen-	421-422
Blasenhals	421
Perineal-	133
Rippen-	392-396
WYLIE , Uterusdilator	444

Y

YANKAUER , Nasenrachenspekulum	341
Saugrohr	10
YEOMAN , Rektumbiopsiezangen	432
YOUNG , Bumerang Nadelhalter	176
Prostatafasszange	420
Prostatahaken	420
Zungenzange	365

Z

Zängchen, Drahtbiege-	236, 329
Fass-	410
Ohr-	326-330, 332-334
Zahnfleischscheren	40
Zangen, Anlege- und Abnahme-	175, 269
-Aufsätze	379
Biopsie-	346
Darm- und Gewebefass-	80, 408-409
Drahtbiege-	236
Drahtschneide-	237
Fremdkörper-	382, 423
Gallenstein-	402
Geburts-	464-466
Gipsabreiß-	181
Hämorrhoidal-	431
Haken-	445-447
Hohlmeißel-	184-189
Kapselfass-	420
Kathetereinführungs-	10
Kehlkopfpolyphen-	378-380
Klemm-	92
Knochenhalte-	192-196
Knochensplitter-	190-191
Knorpel-	197
Kopfschwarten-	80, 467
Kropf-	388
Laminektomie-	276-278
Lungenfass-	397
Nagel-	474
Nasen-	344-346
Nasenpolyphen-	344
Nasenrachen-	359
Nierenstein-	405
Ohrpolyphen-	326
Plazenta- und Abortus-	468
Prostatafass-	420
Rektumbiopsie-	432
Repositions-	369
Schädel-	271
Schließ-	414
Septumricht-	359
Septumquetsch-	347
Sequester-	196-197
Splitter-	65
Sterilisier-	177
Tonsillenfass-	374
Tupfer-	100
Universal-	177
Uterusbiopsie-	451-456
Uterusfass-	448
Uterusklemm-	467
Uteruspolyphen-	448
Zungen-	81, 365
ZAUFAL-JANSEN , Hohlmeißelzange	186
ZENKER , Präparier-/Ligaturklemme	88

Inhaltsverzeichnis

ZIEGLER, Irismesser	287
Kapsulotomiemesser	288
Lidsperrer	285
Stirnspiegel	4
Tränenkanaldilatator	299
Zungendrucker	364

D

Index

A

Abdominal Trocars	146
Adenotome	362
ADLERKREUTZ , Grasping Forceps	62
ADSON , Aspirating tubes	275
Retractor	270
Elevators	215
Forceps	57-58, 61-62
Hemostatic Forceps	83
Micro Forceps	57, 61
Needle-Holders	154
Forceps	274
Retractors	129
Rongeurs	186
ADSON-BABY , Hemostatic Forceps	83
ADSON-BROWN , Grasping Forceps	62
AEBLI , Corneal Scissors	30
Air bag	322
ALLAN-PARKS , Rectal Speculum	429
ALBEE , Burrs	231-232
ALEXANDER , Biopsy Forceps	452
Chisels	202
Gouges	203
Raspatories	212
ALLIS , Intestinal Tissue Forceps	408
ALLIS-ADAIR , Intestinal Tissue Forceps	408
ALLISON , Lung Spatula	397
ALM , Retractors	127
ALVIS , Foreign Body Curette	291
Amniotome	447
Amputation, Knives	20
Retractor	224
Saws	225
ANDREW , Tongue Depressor	364
Angiotribes	79
Angled Plates	262
Anoscopes	430
Antrum, Needles	349
Punch	347
Rasps	357
Apparatus, noise	321
Compression	224
Suturing	417
Aplicators, Cotton	143
Applying Forceps, Clips aneurism	281
Approximators, Rib	396
ARCHER , Splinter Forceps	65
ARLT , Wire Loops	295
ARRUGA , Capsular Forceps	309
Extraction Hooks	292
Eye Speculum	284
Needle-Holders	157, 164
Protector	296
ASCH , Septum Forceps	359
AUFRIEHT , Nasal Rasps	356
Nasal Retractors	359
AUVARD , Vaginal Specula	440
AXENFELD , Chalazion Curettes	295
AYER , Chalazion Forceps	312

B

BABCOCK , Forceps	409
BABINSKY , Hammers	6
BACKHAUS , Towel Forceps	98
BAGGISH , Biopsy Punch	455
BAILEY , Rib Approximators	396
BAILEY-GIBBON , Rib Approximator	396
BAINBRIDGE , Hemostatic Forceps	91
BAKES , Gall Stone Probes	404
BALFOUR , Abdominal Retractors	136
BALLENGER , Rhinoplastic Chisels	355
Septum Elevators	353
Septum Sviwel Knife	351
Tonsil Seizing Forceps	374
Band, Head	4
BANGERTER , Cyclodialysis Spatula	296
Bar, Traction	198
BARANY , Noise Apparatus	321
BARBARA , Hooklets	336
Needles	336
BARKAN , Goniotomy Knife	289

BARNHILL , Adenoid Curettes	361
BARR , Rectal Speculum	428
BARRAQUER , Anterior Chamber Forceps	306
Cilia Forceps	315
Colibri Eye Speculum	284
Colibri Iris Scissors	52
Fixation Forceps	308
Iris Forceps	303
Keratoplasty Knife	290
Needle-Holders	158, 164
BARRAQUER-KATZIN , Iris Forceps	302
BARRETT , Tenaculum Forceps	445
BARTON , Obstetric Forceps	466
Traction Handle	466
Battery Handles for Laryngoscopes	13
BAUMGARTNER , Needle-Holders	153, 159
BEACHAM , Amniotome	447
BECKER , Cystotome	293
BECKMANN , Adenoid Curettes	360
Retractor	130
BECKMANN-EATON , Retractor	130
BEEBEE , Wire Scissors	41
BEER , Cilia Forceps	315
BEESON , Plaster Spreader	181
BELLUCCI , Micro-Scissors	328
BENGOLEA , Hemostatic Forceps	82
BENNET , Bone Lever	216
BERENS , Keratomes	286
BERGMANN , Bandage Scissors	41
Plaster Cast Saw	180
BERKE , Muscle Forceps	306
BERLINER , Reflex Hammer	6
BERNHARD , Towel Forceps	99
BERTILLON , Cephalometer	7
BEST , Intestinal Forceps	413
BETHUNE , Rib Shear	390
BEUSE , Scissors Toothed	32
BEYER , Bone Rongeurs	186
Punch	348
BILL , Tractor	467
BILLEAU , Ear Loops	324
Biopsie Forceps	382-384, 432, 451-456
BIRCHER-GANSKE , Bone Holding Forceps	196
Meniscotomes	221
BISHOP-HARMAN , Iris Forceps	304
Blade, with Coldlight Adaptor	11
Circular Saw	233
Laryngoscopes	11-12
Saw for Electric Cast Cutter	233
Skalpell Sterile	17
Blade Breakers	18
Blades, Corneal Cutter	473
BLAKE , Gall Bladder Forceps	402
Uterine Curettes	458
BLOHMKE , Tonsil Seizing Forceps	374
Blood Pressure Apparatus	2
BLOUNT , Bone Levers	219-220
Knee Retractor	220
BLUMENTHAL , Bone Rongeurs	185
BLUNT , Safety Pin	178
BODENHAMMER , Rectal Speculum	428
BOEHLER , Bone Cutting Forceps	190
Bone Rongeurs	187
Extension Bows	235
Nails	250
BOERMA , Obstetric Forceps	466
BOETTCHER , Tonsil Scissors	32
BOENACCOLTO , Strabismus Forceps	303-304
Bone, Chisels	203-209
Curettes	199-202
Drill Flat	228
Hand Drill	227-230
Holding Forceps	192-197
Levers	216-220
Plates	251-265
Rasps/Files	222
Rongeurs	184-189
Screws	253-258, 264
Surgery Engine	230
Wire	236
BONN , Iris Forceps	305
Irrigating Cannula	313
BORCHARDT , Burrs	232
BOSE , Trachea Hooks	387

Tracheal Spreader 386
BOUCHERON, Ear Specula 319
 Bougies 425
BOWLES, Stethoscope 5
 Bowls 477-478
 Bows, Extension 229
BOWMANN, Discission Knives 287
 Discission Needles 290
 Eye Speculum 284
 Lachrimal Probes 299
 Boxes 477
BOYNTON, Needle-Holder 157
BOZEMANN, Needle-Holders 161
 Swab Forceps 103
BOZEMANN-DOUGLAS, Swab Forceps 103
 Brace 228
 Brain Knives 21
BRAUN, Cranioclast 470
 Decapitation Hook 470
 Tenaculum Forceps 445
 Uterine Depressor 449
BRAUN-STADLER, Episiotomy Scissors 35
 Breaker, Blades 18
BREISKY, Vaginal Specula 441
BROWN-ADSON, Forceps 62
BRUENINGS, Extension Tubes 379
 Forceps tips 379
 Nasal Cutting Forceps 345
 Pneumatic Otoscope 319
 Septum Knife 351
 Tongue Depressor 364
 Tonsil Snare 375
BRUNETTI, Spine Chisel 209
BRUNNER, Ligature Conductors 169
 Intestinal Forceps 413
 Rib Shear 391
BRUNS, Bandage Scissors 42, 49
 Bone Curettes 199-200
BRYANT, Swab Forceps 102
BUCHWALD, Tongue Depressor 364
BUCK, Ear Curettes 323
 Hammer 6
 Foreign Body Lever 327
BUJE, Aspirating Cannula 431
BUMM, Uterine Curettes 461
BUNGE, Exenteration Scoops 294
BUNNEL, Bone Hand Drill 230
 Tendon Strippers 222
BUNT, Safety Needle 178
BURCH, Fixation Fork 289
BURKE, Biopsy Punch 453
 Burrs 226-228, 231-232
BUSCH, Umbilical Cord Scissors 35

C

Cancellous Screws 258
 Cannula, Air 313
 Eye 313
 Irrigating 313, 349
 Aspirating 275
 Puncture 148
CARMALT, Splinter Forceps 64
CARPENTER, Tonsil Knife and Dissector 372
CASTANEDA, Rib Spreader 395
CASTROVIEJO, Blade Breaker 18
 Capsular Forceps 309
 Corneal Scissors 53
 Cyclodialysis Spatula 297
 Eye Speculum 285
 Fixation Forceps 307
 Iridectomy Scissors 53
 Keratome 286
 Lachrimal Dilators 299
 Marker 298
 Needle-Holders 158, 164
 Suturing Forceps 310
 Trepines 314
 Catheters, Ear 322
 Guides 424
 Introducing Forceps 10
 Metal femal/male 426
 Prostate 426
 Cautery 296

Cephalometer 7
CHAPUT, Hemostatic Forceps 81
CHARRIERE, Amputation Saws 225
CHEATLE, Sterilizing Forceps 177
 Cheek Retractor 365
CHERON, Dressing Forceps 102
CHEVALIER-JACKSON, Forceps Larynx 380
CHILDE, Grasping Forceps 175
 Chisels, Bone 203-209
 Extirpation 291
 Nasal Plastic 350
 Septum 353
 Sternum 208
 Chuck 230
 Cilia Forceps 315
CINELLI, Chisels 355
 Circular Saw Blades 233
CITELLI, Punch 348
 Clamps, Anastomosis 400, 414
 Bone Holding 192-196
 Bronchus 87-88, 398-399
 Bulldog 68-69
 Bulldog Atrauma 68
 Common Duct 90-95
 Pedicle 90-95
 Penile 423
 Stomach 414-415
 Tubing 96
 Ureter 406
 Vascular Atrauma 68
CLAR, Head Lamps 4
CLARK, Eye Spekulum 284
CLEVELAND, Bone Rongeurs 184
 Clip Applying Forceps 268
 Clip Carrier Brain 268
 Clips Aneurysma 279-281
 Scalp Hemostasis 269
 Silver Brain Suture 269
CLOWARD, Retractors 132
COACKLEY, Antrum Curettes 360
 Antrum Trocar 147
COLCLOUGH, Punches 278
COLLIER, Needle-Holder 152
COLLIN, Abdominal Retractors 134
 Clip Forceps 175
 Dressing Forceps 102
 Dynamometers 3
 Hammer 210
 Hemostatic Forceps 81
 Pelvimeter 468
 Tongue Holding Forceps 81
 Umbilical Cord Clamp 467
 Uterine Elevating Forceps 448
 Uterine Sound 449
 Vaginal Spekula 434
COLLIN-HARTMANN, Retractor 108
COLLYER, Pelvimeter 468
COLVER, Tonsil Seizing Forceps 374
 Comedo Extractors 472
 Compression Apparatus 224
 Comprimeter 224
 Conductors 169
 Condylar Plates 261
CONNIN-AMSLER, Marker 298
CONVERSE, Nasal Plastic Knife 350
COOLEY, Atrauma Forceps 66
COOPER, Ligature Needles 167
CORDES, Forceps Tip 379
 Corticalis Screws 257
 Corticalis Sinker 241
CORWIN, Tonsil Haemostat 375
CORYLLOS, Thorax Retractors 125
 Rib Shears 390
COS, Forceps Wire Bending 329
COTTLE, Nasal Plastic Chisels 350, 353-354
 Nasal Spekula 342
 Nasal Scissors 31
 Periosteal Elevators 352-352
 Retractors 358
 Septum Knives 351
COTTLE-KATZANJIAN, Bone Cutting Forceps 190
COTTLE-NEIVERT, Retractor 358
 Cotton Applicators 143
COXETER, Catheters Prostate 426

Index

CRAFOORD , Bronchus Clamp	88
Lung Scissors	38
Cranioclast	470
CREDO , Corneal Cutter	473
CRILE , Hemostatic Forceps	72
Needle-Holder	156
Retractors	108
153, 159	
CRILE-RANKIN , Hemostatic Forceps	73
CRILE-WOOD , Needle-Holders	153, 159
CRITCHETT , Eye Spekulum	284
CRUTCHFIELD , Drill Bits	269
Traction Tonges	269
CULLER , Iris Spatula	296
Curettes, Abortion	469
Antrum	360
Aspiration	450
Bone	199-202
Chalazion	293-295
Ear	323, 327
Foreign Body	291
Lupus	472
Uterine	458-461
CUSCO , Vaginal Specula	435
CUSHING , Brain Spatula	274
Flat Burr	228
Forceps Thumb and Tissue	57, 61
Forceps Laminectomy	276
Nerve Hooks	270
Retractors	113
Cuticle, Nipper	474
Scissors	473
Cutter, Corneal	473
Diamant Wire	237
CUZZI , Abortion Scoop	469
Cystotome	293
CZERNY , Rectal Spekulum	428

D

DANDY , Hemostatic Forceps	79
Nerve Hooks	270
Neurosurgical Scissors	37
DARLING , Retractors	131
DARTIGUES , Uterus Elevating Forceps	448
DASTOOR , Erisophake	298
Strabismus Forceps	304
DAVIDSON , Scapula Retractors	126
DAVIEL , Cataract Spoon	294
DAVIS , Dissector	273
Foreign Body Needle	290
Sterilizing Forceps	177
DAVIS-BOYLE , Mouth Gags	367
DAY , Ear Hooklets	325
DEAN , Iris Knife	287
Tonsil Scissors	31
DEAVER , Retractors	109-110
Scissors	25, 44
DE BAKEY , Atrauma Forceps	66
Bulldog Clamps Atrauma	68
Needle-Holders	160
Vascular Scissors	32-33
DEJERINE , Hammers	6
DE LEE , Obstetric Forceps	464
DE MARTEL , Saw Conductor	272
Scalp Flap Forceps	80
DE MARTEL-WOLFSON , Anastomosis Forceps	414
Clamp Holder	414
Closing Forceps	414
DENHART , Mouth Gag	366
Depressor, Tongue	367-368
DERF , Needle-Holders	152, 159
Dermatome	22
DESCHAMPS , Ligature Needles	166
DESJARDINS , Common Duct Clamps	402
Gall Stone Forceps	92
Gall Stone Probe	403
Gall Stone Scoop	403
DESMARRES , Chalazion Forceps	312
Eye Retractors	286
DEUTSCHMANN , Cataract Knife	286
DE VILBISS , Skull Forceps	271
DEWEY , Forceps Obstetrical	466
Diagnostic Sets	3, 11-13

Diamant Wire Cutter	237
Dieffenbach , Serrefine	69
DIETER , Malleus Nippers	330
DIETHRICH , Needle-Holders	164
Dilators, Lachrimal	299
Tracheal	386
Urethral	425
Uterine	442-444
DINGMANN , Bone Holding Forceps	197
Director, Grooved	141-141
Goitre	388
Disposable, Scalpels Sterile	17
Dissecting, Forceps	56-58
Scissors	29, 36-38
Dissectors, Corneal	288, 291
Head	272-273
Lachrimal	295
Tonsil	372
DIX , Foreign Body Instruments	291, 298
DOUGLAS , Trocar	147
DOYEN , Abdominal Retractors	122
Burrs	231
Costal Periosteal	213
Grooved Director	141
Gynecological Scissors	34
Intestinal Forceps	410
Myoma Screw	457
Spherical Burrs	231
Towel Forceps	99
Uterus Polypus Forceps	448
Vaginal Specula	440
DOYEN-JANSEN , Mouth Gag	366
Dressing Forceps	56-58
Dressing and Cotton Forceps	100
Dressing and Swab Forceps	101-103
Drills	227-228, 231
Bone Hand Drills	227-230
Driver, Nail/Screw	240
DUBOIS , Gynecological Scissors	35
DUPLAY , Tenaculum Forceps	445
DUPLEX , Stethoscope	5
DUPUY-WEISS , Tonsil Needle	373
Dissectors	272-273
DUVAL , Grasping Forceps	62
DUVAL-COLLIN , Forceps	409
Grasping Forceps	62
Dynamometers	3

E

Ear, Curettes	323, 337
Forceps	326-330, 332-334
Katheters	322
Knives	323-324
Loops	324
Polypus Snares	326
Probe	141
Specula	318-319
Syringes	322
ECHLIN , Bone Rongeur	187
Electric, Bone Engine	230
Plaster Saw	182
Elevators, Periosteal	213-214, 352
Septum	352
Tonsil	372
ELLIOT , Obstetric Forceps	464
Trepines	314
ELLIS , Foreign Body Gouge	291
ELSCHNIG , Capsular Forceps	308-309
Corneal Knife	288
Cyclodialysis Spatula	297
Fixation Forceps	307
EMMET , Fistula Hook	457
ENGEL , Plaster Cast Saw	180
Engine, Bone Surgery	230
Enucleation Scissors	30
EPPENDORFER , Biopsy Punch	455-456
Erisophake	298
ESMARCH , Bandage Scissors	42
Plaster Knife	181
EVES , Tonsil Snares	375
Extension Bow	235
Extraction Hooks	239, 292
Extractors, Comedo	472

- Nail 239
- F**
- FARABEUF**, Bone Holding Forceps 192
Raspatories 212
Retractors 106
- FARABEUF-LAMBOTTE**, Bone Holding Forceps 192
- FARREL**, Cotton Applicators 143
- FAULKNER**, Curettes 360
- FAURE**, Peritoneum Forceps 95
Uterine Biopsy Forceps 451
- FEHLAND**, Intestinal Forceps 413
- FEILCHENFELD**, Splinter Forceps 64
- Femal Catheter Metal 426
- FERGUSON**, Angiotribes 79
Gall Stone Scoop 403
- FERGUSON**, Bone Holding Forceps 192
- FERRIS-SMITH**, Laminectomy Forceps 277
Tissue Forceps 60
- FERRIS-SMITH-KERRISON**, Punches 278
- Files, Bones and Rasps 222
Nail 473
- Finger Bandage Scissors 30
- Finger, Nail Perforator 226
Plates 263
Protectors 369
Ring Saw 226
- FINOCHIETTO**, Bronchus Clamp 398
Needle-Holders 155, 162
Rib Spreaders 392-393
- FINOCHIETTO-BURFORD**, Rib Spreaders 393-394
- FINSEN**, Retractors 127
- FISCH**, Dissectors 337
- FISCHER**, Iris Forceps 302
- Flat Nose Pliers 236
- FLEURANT**, Trocar for Bladder 147
- FOERSTER**, Iris Forceps 301
Swab Forceps 101
- FOMON**, Alar Retractor 358
Chisels 354
Nasal Rasps 357
Nasal Scissors 31
Retractor Posterior Nares 358
- Forceps, Angiotribes 79
Anastomosis 400, 414
Anterior Chamber 306
Applying 175, 269
Applying and Removing 175, 269
Approximation 175
Atrauma 66
Atrauma Bulldog 68-69
Bone Cutting 190-191
Bone Holding 192-196
Brain Clip Applying 269
Bronchus 87-88
Capsular 308-309
Cartilage 197
Catheter Introducing 10
Cervical Biopsy and Specimen 451-456
Chalazion 312
Cilia 315
Cranial Rongeur 271
Cotton Swab 100-103
Dissecting 56-58
Dressing 56-58
Ear Dressing 343
Entropium 312
Fixation 307-308
Gall Duct 92-93
Gall Stone 402
Grasping 62-63, 408-409
Haemorrhoidal 431
Hemostatic 67-96
Hypophyseal 274
Hysterectomy 94-95
Intestinal 408-409
Iris 300-305
Kidney Pedicle Clamp 92-94
Kidney Stone 405
Ligature 84-86
Muscular 306
Nasal Dressing 343
Obstetrical 464-466
Ovarian 431
Peritoneal Clamp 94-95
Placenta and Ovum 468
Rectal Biopsy Specimen 432
Scalp Flap 80
Sequester 196-197
Splinter 64
Sponge Holding 100
Sterilizing 177
Strabismus 303-304
Suture 310-311
Tampon 100
Tenaculum 445-447
Thorax 86
Tissue 59-61
Tongue Holding 81
Tonsil Seizing 374
Towel 98-99
Trachoma 312
Tubing Clamps 96
Tungsten Carbide 58, 305-306, 310-311, 409
Uterine Elevating 448
Uterine Polypus 448
Vascular 57-58, 61
Vulsellum 447
Watchmaker 64
- FORD**, Stethoscope 5
- FORD-BOWLES**, Stethoscope 5
- FOREGGER**, Laryngoscopes 12
- Foreign Body, Elevator 327
Needles 290-291
Remover and Magnetic Eye Probe 315
- FOX**, Lupus Curettes 472
- FRAENKEL**, Forceps Tips 379
Laryngeal Polypus Forceps 378
- FRANCESCHETTI**, Trephines 314
- FRANCIS**, Foreign Body Needle 290
- FRANCKE**, Blood Lancet 3
- FRANKLIN-SILVERMANN**, Biopsy Needle 149
- FRAZIER**, Abdominal Retractor 135
Aspirating Cannulas 275
Hooklet 111
- FREER**, Septum Knife 350
Gouge 355
Mucosa Knife 350
Septum Chisel 353
Septum Elevator 352
- FRENZEL**, Tongue Depressor 364
- FRIEDMANN**, Bone Rongeurs 184
Retractor Perineorrhaphy 441
- FRITSCH**, Retractors 121
- FRYKHOLM**, Bone Rongeur 188
- FUCHS**, Capsular Forceps 309
- G**
- GALLAHER**, Antrum Rasps 357
- GAUSS**, Scalp Flap Forceps 467
- GELLHORN**, Biopsy Forceps 451
- GELPI**, Perineal Retractors 133
- GEMINI (Mixer)**, Dissecting and Ligature Forceps 85
- GERALD**, Forceps 57, 61
- GERSTER**, Traction Bar 198
- GERZOG**, Hammer 210
- GIERTZ-STILLE**, Rib Shears 391
- GIGLI**, Handle for Wire Saws 272
- GILL**, Corneal Dissector 288
Iris Forceps 302
- GILL-ARRUGA**, Capsular Forceps 308
- GILL-HESS**, Iris Forceps 302
- GILLIES**, Forceps 60
Hooklet 358
Needle-Holders with Scissors 157, 163
- GLOVER**, Clamps Vascular Atrauma 68
- GLUCK**, Rib Shears 390
- GOELET**, Retractor double 108
- GOLDSTEIN**, Eye Speculum 285
- Goniometer 7
- GOOD**, Tonsil Scissors 32
- GOODELL**, Uterine Dilator 444
- GOSSET**, Abdominal Retractors 135
Gouges 203-208
- GRADLE**, Cilia Forceps 315
Graduated Measures 7

Index

Rulers	7
GRAEFE , Cataract Knives	286
Cataract Spoon	294
Cystotome	287
Eye Speculum	284
Fixation Forceps	307
Forceps	62
Hooklets	111, 293
Iris Forceps	300
Scarifier	287
Strabismus Hooks	292
GRAHAM , Nerve Hook	270
GRAVE , Vaginal Specula	434
GRAY , Common Duct Clamp	93
GREEN , Corneal Dissector	291
Fixation Forceps	308
Muscle Hook	291
Thyroid Gland Retractor	119
GREEN-ARMYTAGE , Uterus Hemostatic Forceps	467
GREVEN , Forceps Wire Bending	329
Grooved Directors	140-141
GROSS , Ear Spoon and Hook	324
Ear Loops and Hook	324
GROSS-MAIER , Dressing Forceps	100
GRUBER , Ear Specula	318
Guide, Hand drill Telescopic	229
Guide Pin	229
Gum Scissors	40
GUTHRIE , Double Hooklets	111
GUTMANN , Secretion Scoop	424
GUYON , Dilating Bougies	425
Mandrel for Rubber Catheter	424
Pedicle Clamps	93
GUYTON-LUNDSGAARD , Sclerotome	289

H

HABERER , Retractors Malleables	109
Haemorrhoidal Forceps	431
HAGLUND-STILLE , Plaster Spreader	181
HAIGHT , Rib Spreader	395
HAJEK-BALLENGER , Septum Elevator	353
HAJEK-CLAUS , Antrum Punch	347
HAJEK-KOFLER , Punches	347
HALLE , Bone Curettes	201
Dura Knife	273
HALSEY , Needle-Holders	152, 159
HALSTEAD-MOSQUITO , Hemostatic Forceps	71
Hammers	6, 210-211
Hand Bone Drills	227-230
Handles, Traction	467
Battery for Laryngoscopes	13
For Laryngeal Mirrors	343
For Vein Strippers	141
For Wire Saws	272
Scalpel	16
Universal	379
HANK , Uterine Dilators	444
HARRINGTON , Bronchus Clamps	398
Retractor	109
HARTMANN , Ear Specula	318
Ear Catheter	322
Ear Forceps	326-327
Hemostatic Forceps	70
Nasal Cutting Forceps	346
Tongue Depressor	364
Tuning Forks	320
HARTMANN-HALLE , Nasal Specula	340
HARTMANN-HOFFMANN , Ear Forceps	328
HARTMANN-WULLSTEIN , Ear Forceps	328
HAUGH , Ear Forceps	329
Head Bands	4
HEANEY , Hysterectomy Forceps	95
Needle-Holders	154, 161
Retractor	124
HEATH , Ligature Scissors	39
HEBRA , Chalazion Curette	294
HEGAR , Uterus Dilators	442
HEGENBARTH , Clip Applying Forceps	175
HEIFETZ , Brain Spatula	274
HEISS , Hemostatic Forceps	83
HEISTER , Mouth Gag	366
HENKE , Tonsil Elevator	372
HENNIG , Plaster Spreader	181

HERRICK , Pedicle Clamp	94
HESS , Capsular Forceps	309
Iris Forceps	302
HEYMANN , Nasal Scissors	31
HEYMANN-KNIGHT , Nasal Forceps	345
Nasal Cutting Forceps	344
HEYWOOD-SMITH , Ovarian Forceps	431
HIBBS , Bone Chisels	208
Gouges	208
Osteotomes	207
HIRSCHMANN , Anuscope	430
HOESEL , Needle-Holder	155
HOFER , Pilar Retractor	372
HOHMANN , Bone Levers	217-220
HOKE , Osteotomes	205
HOLTH , Corneoscleral Punch	298
Hooks, Decapitation	470
Cystic	431
Extracting	239, 292
Fistula	457
Lens	291-292
Muscular	138, 291
Nerve	270-271
Obstetrical	467
Prostate	420
Trachea	386-387
Hooklets, Dura	111
Ear	325, 335-337
Iris	111, 292-293
HOPKINS , Plaster Knife	181
HORSLEY , Dissector	273
HOUSE , Curettes	337
Measuring Rods	338
HUBER , Universal Handle	379
HUDSON , Brace	228
HUNTER , Splinter Forceps	64
HURD , Tonsil Dissector	372

I

Impactor, Nail	239
Incision Scissors	25
INGE , Vertebral Spreader	275
Instrument Trays	480
IOWA , Vulsellum Forceps	447
Iris, Forceps	300-305
Hooklets	111, 292-293
Knives	287
Spatula	296
Scissors	29, 47, 52
ISRAEL , Retractors	120
ITARD , Ear Catheter	322
ITERSON , Trachea Hooks	386
IVES-FANSLER , Anoscope	430

J

JACKSON , Tampon Forceps	378
Trachea Hooks	386
Tracheostomy Tubes	387
Vaginal Specula	439
Jacobs Chuck	230
JACOBS , Vulsellum Forceps	447
JAEGER , Keratomes	286
Lid Plate	285
JAMESON , Strabismus Forceps	303
Strabismus Hook	291
JAMISON , Needle-Holders	153, 161
JANSEN , Nasal Forceps	343
Retractors	127
Jars	477-478
JARCHO , Tenaculum Forceps	446
JATHO , Nasopharyngeal Cutting Forceps	359
JENNINGS , Mouth Gag	366
JEWETT , Nails	251
JOBSON-HORNE , Cotton Applicators	143
JOHNS-HOPKINS , Hemostatic Forceps	91
Serreffines	69
JOHNSON , Needle-Holder	155
JONES , Towel Clips	98
JOSEPH , Bone Files	356
Mucous Hooklet	111
Nasal Rasps	356, 358

Nasal Saws	358
Periosteal Elevator	353
Plastic Knives	350
Scissors	29
JUDD-ALLIS , Forceps	408
JUDD-MASSON , Bladder Spreader	421
JUERS , Forceps Wire Bending	329
JURASZ , Laryngeal Polypus Forceps	378

K

KABIERSKE , Powder Blower	321
KALLMORGEN , Vaginal Retractors	439
Vaginal Specula	439
KALT , Capsular Forceps	308
Needle-Holder	158
KALT-ARRUGA , Needle-Holder	158
KANE , Umbilical Cord Clamp	467
KEITH , Suture Needles	173
KELLY , Gynecological Scissors	36
Hemostatic Forceps	72
Proctoscopes	430
Retractors	107, 124
Uterine Polypus Forceps	448
KELLY-RANKIN , Hemostatic Forceps	72
Keratomes	286
KERN , Bone Holding Forceps	193
KERRISON , Punches	347
KEVORKIAN , Biopsy Curettes	450
Biopsy Forceps	452
KEVORKIAN-PACIFIC , Biopsy Punch	453
KEY , Elevators	215
KEYES , Cutaneous Punches	473
Kidney Bowls	478
KIELLAND , Obstetrical Forceps	465
KIELLAND-LUIKART , Obstetrical Forceps	465
KILLIAN , Nasal Specula	341
Septum Elevator	352
Suction Cannula	349
KILLIAN-CLAUS , Septum Gouges	355
KILNER , Plastic Surgery Scissors	29, 47
Skin Retractors	472
KILNER-DOUGHTY , Mouth Gag	367
KIRBY-ARTHUR , Iris Forceps	304
KIRK , Hammer	210
KIRSCHNER , Abdominal Retractors	137
Bow Extension	235
Hand Drills	229
Drill Guide Telescopic	229
Ligature Conductor	169
Wire Drills	234
KLINKENBERGH-LOTH , Thorax Scissors	38
KNAPP , Cataract Spoon	295
Iris Knives	287
Hooklet	293
KNAPP-LUER , Trachoma Forceps	312
Knives, Amputation	20
Brain	21
Capsulotomy	288
Cartilage	21
Cataract	286
Circular	335
Corneal	288
Discision	287-288, 290
Dura	273
Ear	323-324, 335
Goniotomy	289
Iris	287
Keratoplasty	289-290
Mucosa	350
Myoma	457
Periosteal	338
Plaster	181
Resection	21
Septum	351
Sicle	335
KNIGHT , Nasal Cutting Forceps	345
KNOWLES , Bandage Scissors	42
KOCHER , Bladder Retractors	422
Goitre Directors	388
Hemostatic Forceps	78
Intestinal Forceps	411
Retractors	118-119, 122
KOENIG , Ligature Conductor	169

Suturing Needles	172
KOERTE , Retractors	121
KOGAN , Endo Speculum	441
KONRICH , Sterilisation Boxes	479
KRAUSE , Forceps Tips	379
Ear Snares	326
Nasal Snares	349
KRISTELLER , Vaginal Retractors	436-438
Vaginal Specula	436-438
KRONECKER , Ligature Needles	167
KUENTSCHER , Nails	245-249
Nail Drivers	238-239
Nail Extractors	238-239
Nail Impactors	238-239
Nail Reamer Femur	238-239
KUHNT , Corneal Scarifier	289

L

LABORDE , Trachea Dilatators	386
LA FORCE , Adenotome	362
Foreign Body Instrument	291
LAHEY , Common Duct Forceps	91
Goitre Seizing Forceps	388
Retractor	114
LAMBERT , Chalazion Forceps	312
LAMBOTTE , Bone Holding Forceps	192-193
Osteotomes	206
Raspatories	212
Lamps, Head	4
Spare for Laryngoscopes	13
LANCASTER , Eye Speculum	285
LANDAU , Vaginal Specula	441
LANE , Bone Holding Forceps	194
Forceps for Bone Screw	240
Forceps Thumb and Dressing	60
Screw Driver	240
Stomach Clamp Forceps	415
Towel Forceps	99
LANG , Lachrymal Sac Dissector	295
LANGE , Forceps Tips	379
LANGENBECK , Bone Holding Forceps	192
Elevators	212, 214
Finger Protectors	369
Finger Saw	225
Periosteal Elevator	212
Resection Knives	21
Retractors	116-117
Laryngeal Mirrors	380
Laryngoscopes	11-13
LAWRENCE , Hemostatic Forceps	89
Lead Hand	198
LEBSCHKE , Sternum Chisel	208
LEGUEU , Bladder Retractor	421
Bladder Spatula	422
LEKSELL , Bone Rongeurs	189
LEMPERT , Bone Curettes	201
Bone Elevators	338
Rongeurs	186
LERICHE , Tissue Forceps	62
LERICHE , Hemostatic Forceps	82
LESTER , Fixation Forceps	307
Levers, Bone	216-220
Foreign Body	327
LEVINSON , Foreign Body Needle	290
LEWIN , Bone Holding Forceps	196
LEXER , Bone Chisels	205-206
Gouges	205-206
Scissors	26, 45
LEXER-BABY , Scissors	27, 45
LICHTWITZ , Antrum Trocar	147
Lip and Cheek Retractors	365
LISTER , Bandage Scissors	41, 49
Swab Forceps	102
LISTER-BURCH , Eye Speculum	285
LISTON , Amputation Knives	20
Bone Cutting Forceps	190
LITTAUER , Cilia Forceps	315
Ear Forceps	326
Ligature Scissors	39
Nasal Polypus Forceps	344
LITTLE , Retractor	114
LLOYD , Extractor/Impactor	240
Loops	295, 324, 326

Index

LORENZ , Bandage Scissors	42
LORNA , Towel Forceps	99
LOUTE , Wire Tightener/Twister	236
LOVE , Nasopharyngeal Retractor	372
Nerve Retractor	271
LOVE-GRUENWALD , Laminectomy Forceps	276
LOVELACE , Hemostatic Forceps	80
Lung Grasping Forceps	397
LOWER , Gall Duct Forceps	91
LOWMAN , Bone Holding Clamps	198
LUBET-BARBON , Nasal Polypus Forceps	344
LUC , Nasal Cutting Forceps	345
LUCAE , Ear Forceps	325
Hammer	210
Tuning Forks	321
LUER , Bone Rongeurs	185
Tracheostomy Tubes	387
LUIKART , Obstetrical Forceps	465
LUIKART-BILL , Tractor	467
Lumbar Puncture Needles	148
LUNDGAARD , Sclerotome	288
LUNIATSCHEK , Tonsil Gauze Packer	372
LURZ , Urethra Clamps	406

M

MAGILL , Catheter Introducing Forceps	10
MAISONNEUVE , Urethrotome	423
Malleolar Screws	257-258
Mallets	6, 210-211
MALTZ , Nasal Rasp	356
Manometers	2
Markers	298
MARSHIK , Tonsil Seizing Forceps	374
MARTIN , Cartilage Holding Forceps	197
Pelvimeter	468
Uterine Sounds	449
MARTINI , Bone Curettes	202
MASSON , Needle-Holders	154, 162
MASTIN , Muscular Forceps	388
MATHIEU , Foreign Body Forceps	423
Needle-Holders	156, 163
Rectal Speculum	428
Retractors	106
MATSON , Periosteal Elevator	214
MATSON-ALEXANDER , Periosteal Elevator	214
MAUNDER , Oral Screw	369
MAYO , Gall Stone Scoop	403
Kidney Stone Probe	406
Safety Pin	178
Scissors	26, 44
MAYO-BLAKE , Gall Bladder Forceps	402
MAYO-GUYON , Kidney Pedicle Clamp	92
MAYO-HEGAR , Needle-Holders	153, 160
MAYO-NOBLE , Scissors	27
MAYO-ROBSON , Intestinal Forceps	412
MAYO-STILLE , Scissors	26, 45
McCULLOUGH , Strabismus Forceps	303
McDONALD , Elevator	215
McGEE , Ear Forceps	329
Hooklets	336
McGUIRE , Corneal Scissors	52
McINDOE , Cartilage Scissors	37
Forceps serrated	56
McINTOSH , Laryngoscopes	11
McIVOR , Mouth Gag	367
McKENTY , Septum Elevator	352
McKENZIE , Clip Applying Forceps	268
Cutter for Hudson Brace	228
McLAUGHLIN , Bone Plates	251
McLEAN , Obstetrical Forceps	465
McLEAN-LUIKART , Obstetrical Forceps	465
McLEAN-TUCKER , Obstetrical Forceps	465
McLEAN-TUCKER-LUIKART , Obstetrical Forceps	465
McPHERSON , Tying Forceps	311
MEAD , Hammer	211
Bone Rongeurs	184
Measures	7
Measuring Probes	338
MEEKER , Hemostatic Forceps	89
MELLINGER , Eye Speculum	285
MELLINGER-AXENFELD , Eye Speculum	284
MENGHINI , Punction Needles	148
Meniscotomes	221

MERCEDES , Thorax Spreader	396
METZENBAUM , Needle-Holder	154
Scissors	27-28, 46-47
METZENBAUM-FINO , Scissors	28, 46
MEYERDING , Retractor	114
MEYHOEFER , Chalazion Curette	293
MICHEL , Clips	176
Clip Applying Forceps	175
Mirrors Postrhinoscopic	343
Micro, Forceps	64, 66, 328-330, 332-334
Scissors	51-54, 328, 330-331
MIDDELDORPF , Retractors	119
MIDDLETON-JANSEN , Nasal Cutting Forceps	348
MIKULICZ , Peritoneum Forceps	95
Retractors	123
MILLIGAN , Dissector	272
MILLIN , Bladder Neck Spreader	421
Capsule Forceps	420
Ligature Conductor	421
Prostatic Lobe Holding Forceps	421
Mini, Clips Aneurysma	279
Clip Applying Forceps	281
Fragment Plates	264
Screws Cross Slot	255
Mirrors, Head Lamps	4
Laryngeal	380
Postrhinoscopic	343
MIXTER , Common Duct Forceps	92, 402
Gall Stone Forceps	402
Hemostatic Forceps	89-90
MIXTER-BABY , Hemostatic Forceps	90
MIXTER-O'SHAUGNESSY , Hemostatic Forceps	90
MOD. BERLIN , Tubing Clamp	96
MOD. WIEN , Nasal Spekula	341
MOELTGEN , Goniometer	7
MOLLISON , Retractor	131
MOORE , Bone Hand Drill	228
Gall Stone Scoop	402
MOORFIELD , Suture Forceps	310
Mouth Gags	366-368
MOYNIHAN , Clamps	92
Gall Stone Probe	403
Towel Forceps	99
MUCK , Periosteal Knife	338
MUELLER , Eye Speculum	285
MURDOCK , Eye Speculum	284
MURPHY-LANE , Bone Elevator	226
Muscle Retractors	138, 291
MUSEUX , Vulsellum Forceps	446
MYLES , Nasal Cutting Forceps	346
Myrtle Leaf Probes	140

N

NABATOFF , Varicose Vein Probe Set	141
NAEGELE , Obstetrical Forceps	464
NAGER , Palate Retractor	372
Nail, Files	473
Impactor/Extractor	238-239
Nipper	474
Scissors	473
Nails, Bone	244-250
Nasal, Forceps	344, 359
Saws	358
Scissors	29, 31-32
Specula	340-342
Needle-Cases	
Needle-Holders	151-164
Needles, Ligature	166-168
Suture	170-174
NEFF , Meniscotomes	221
NEGUS , Tonsil Forceps	373
NEIVERT , Needle-Holder	152
NELSON , Tissue Forceps	63
Ligature Needles	167
Thorax Trocar	147
Nerve, Dissecting Scissors	37
Hooks	270-271
Retractors	113
Neurosurgery	268-274, 279-281
NORTHBENT , Stich Scissors	29
NOTO , Uterus Polypus Forceps	448
NOVAK , Aspiration Curettes	450

NOYES, Iris Scissors 52
 Nasal Polypus Forceps 344

O

O'CONNOR, Iris Hook 292
O'SULLIVAN-O'CONNOR, Abdominal Retractor 135
OCHSNER, Gall Stone Probe 403
 Thorax Trocar 148
OLDBERG, Laminectomy Forceps 277
OLIVECRONA, Spatula 274
 Bone Rongeur 185
 Wire Saws 272
OLIVECRONA-TOENNIS, Clip Applying Forceps 268
OLLIER, Retractor 120
OLSEN-HEGAR, Needle-Holders 156-157, 163
 Ophthalmoscopy 3
 Osteosynthesis 240-241
 Osteotomes 203-209
 Otoscopy Set 3
OVERHOLT, Periosteal Elevators 214
OVERHOLT-GEISSENDOERFER, Hemostatic Forceps 84

P

Parametrium Scissors 34
PARHAM, Band/Band Tightener 198
PARK, Eye Speculum 285
PARKER, Retractors 106
PARKER-LANGENBECK, Retractors 106
 Scalpels 20
PARTSCH, Bone Chisels 204
 Gouges 204
PASSOW, Hemostatic Chisels 338
PATON, Corneal Dissector 288
PAUFIQUE, Keratoplasty Knife 289
 Tying Forceps 311
PAYR, Intestinal Crushing Clamps 416
 Ligature Conductors 169
PEAN, Hemostatic Forceps 73, 80
PEDERSON, Vaginal Specula 434
PEET, Splinter Forceps 65
PELKMANN, Dressing Forceps 102
 Pelvimeter 468
PENFIELD, Dissectors 273
PENNINGTON, Hemostatic Forceps 80
PERCY, Amputation Retractor 224
 Percussion Hammers 210-211
 Perforated Trays 480
 Periosteal Knife 338
PERTHES, Reamer 232
PESTALOZZA, Abortion Curette 469
PHANEUF, Peritoneum Forceps 94
PIERCE, Antrum Trocars 146
PIFFARD, Lupus Curettes 472
PINARD, Stethoscope 5
 Pin Wheel 7
PIPER, Obstetrical Forceps 466
PITHA, Mouth Prop. 369
 Placenta and Ovum Forceps 468
 Plaster, Saws 180, 182
 Shears 180
 Spreaders 181
PLESTER, Flap Knife 335
 Retractors 128
 Pliers, flat nose 236
POLITZER, Air bag 322
 Paracentese Needles 323
POOLE, Aspiration Tubes 10
 Post Mortem Set 209
POTTS-DE MARTEL, Vascular Scissors 33
POTTS-SMITH, Vascular Forceps 57-58, 61
 Vascular Scissors 33, 48
 Powder Blower 321
PRATT, Cystic Hook 431
 Hemostatic Forceps 80
 Rectal Speculum 428
 Vulsellum Forceps 447
PRESBYTERIAN-HOSPITAL, Tubing Clamp 96
PRICE-THOMAS, Bronchus Clamps 398
PRINCE, Muscular Forceps 306
 Tonsil Scissors 32
 Probes 140-141
 Proctoscopes 430

PROVIDENCE-HOSPITAL, Hemostatic Forceps 73
PUTTI, Bone Rasp 222

Q

QUINBY, Gum Scissors 40
QUINKE, Pneumoperitoneum-Canule 149
QUIRE, Foreign Body Levers 327
QUISLING, Hammer Intranasal 211

R

RADOLF, Nail Extracting Forceps 226
RALK, Bone Hand Drill 230
 Splinter Forceps 65
RAMPLEY, Swab Forceps 101
RANDALL, Aspirating Curette 450
 Kidney Stone Forceps 405
RANEY, Applying and Removing Forceps 269
 Scalp Hemostasis Clip 269
 Raspatories 212-215
 Rasps, Antrum 357
 Bone 222
 Nasal 356-357
 Razor Blades Holder and Breaker 18
 Reamers 232
RECAMIER, Uterine Curettes 460
REICHERT, Epiglottis Retractor 358
REINER, Ear Syringes 322
 Plaster Knife 181
 Retractors, Abdominal 122, 124
 Bladder 421-422
 Lip and Cheek 365
 Epiglottis 358
 for Amputation 224
 Goitre 114
 Knee 220
 Muscle 138, 291
 Nerve 270-271
 Palate 372
 Perineal 133
 Prostatic 420
 Scapula 126
 Self Retaining 127-137
 Skin 111
 Thorax 125
 Trachea 386-387
 Uvula 372
 Vaginal 434-441
 Wound 105-138
REVERDIN, Abdominal Retractor 109
 Ligature Needles 168
REYNOLDS, Dissecting Scissors 29, 47
 Rhachiotome 209
 Rhinology 339-362
 Rhinoplastic Knives 350
 Rib, Approximators 396
 Shears 390-391
 Spreaders 392-396
RICHARDSON, Retractor 107
RICHARDSON-EASTMAN, Retractor 107
RICHTER-HEATH, Clip Forceps 175
RIGBY, Retractor 133
ROBERTS, Hemostatic Forceps 87
ROCHESTER-CARMALT, Hemostatic Forceps 78
ROCHESTER-OCHSNER, Hemostatic Forceps 76
ROCHESTER-PEAN, Hemostatic Forceps 74
ROEDER, Towel Forceps 98
ROGER, Septum Elevator 352
ROGGE, Sterilizing Forceps 177
ROLLET, Extirpation Chisel 291
 Iris Hooklet 292
 Rongeurs 184-189
ROSE, Trachea Hook 387
ROSEN, Knife Circular 335
 Needles 336-337
ROSENBERG, Forceps Tip 379
ROSER-KOENIG, Mouth Gag 366
 Round Bowls 478-479
ROUX, Retractors 106, 108
ROUX-BABY, Retractors 108
ROWE, Forceps Disimpaction 369
RUBIN, Septum Crushing Forceps 347
 Rulers 7

E

Index

RUMEL, Thorax Forceps 86
RUSKIN, Bone Rongeurs 186-187
RUSKIN-LISTON, Bone Cutting Forceps 190
RUSS. MODELL, Tissue Forceps 62
RYDEL-SEIFFER, Tuning Fork 321
RYDER, Needle-Holders 161

S

SAALFELD, Comedo Extractor 472
SACHS, Dissectors 272
 Nerve Hook 271
SAENGER, Placenta and Ovum Forceps 468
Safety Pins 178
Salpingograph 457
SANVENERO, Scissors 28
SAROT, Bronchus Clamps 87
 Needle-Holders 155, 161
SATINSKY, Clamps Anastomosis 400
 Thorax Scissors 38
SATO, Corneal Knife 288
SATTERLEE, Amputation Saw 225
SAUERBRUCH, Bone Rongeurs 189
 Needle Cases 476
 Retractors 125
 Rib Shear 391
SAUERBRUCH-FREY, Rib Shear 391
Saws, Amputation 225
 Finger 225
 Fingerring 225
 Nasal 358
 Plaster 180, 182
 Wire 272
SAWTELL, Tonsil Forceps 373
Scalpels 19
Scalpel, Blades 17
 Handles 16
Scalp Hemostasis Flip 467
Scalp Flap Forceps 80
Scapula Retractor 126
Scarifier 287
SCHAEDEL, Towel Clip 98
SCHAMBERG, Comedo Extractor 472
SCHUDE, Bone Curettes 199
SCHIEE, Eye Cannulas 313
 Goniotomy Knife 289
SCHIEINMANN, Forceps Tips 379
SCHIMMELBUSCH, Sterilizing Boxes 479
SCHINK, Dermotome 22
SCHIOETZ, Tonometer 314
SCHMIEDEN, Ligature Conductor 169
SCHMIEDEN-PAYR, Ligature Conductor 169
SCHMIEDEN-TAYLOR, Dura Scissors 37
SCHNIDT, Tonsil Forceps 373
SCHOENBORN, Thyroid Retractor 388
SCHOENBURG, Intestinal Grasping Forceps 410
SCHROEDER, Tenaculum Forceps 445-446
SCHUBERT, Biopsy Forceps 451
SCHUKNECHT, Roller Knife 335
 Sickle Knife 335
SCHULTZE, Salpingograph 457
SCHUMACHER, Biopsy Forceps 452
 Forceps Tip 379
 Umbilical Cord Scissors 37
SCHWEIGGER, Capsular Forceps 309
Scissors, Bandage 41-42, 49
 Cartilage 37
 Corneal 30, 52-53
 Cuticle 473
 Dissecting 29, 36-38, 45-46
 Dura 37
 Enterotomy 39
 Episiotomy 35
 Fistula 36
 Gum 40
 Gynecological 34-35
 Incision 25
 Iridectomy 53
 Iris 29
 Ligature 39
 Lung 37-38
 Micro 51-54
 Nasal 29, 31-32
 Neurosurgical 36

Operating 24-29, 36, 43-46
Ophthalmology 51-53
Parametrium 34
Plaster 180
Plastic Surgery 29
Plate and Wire 41, 49
Strabismus 30
Surgical 24-29
Tenotomy 30
Thorax 38
Tonsil 31-32
Tungsten Carbide 43-49
Umbilical Cord 35
Uterus 34
Vascular 32-33, 48
SEDILLOT, Periosteal Elevator 212
SEEMANN-SEIFFERT, Mouth Gags 366
SEGOND, Myoma Knife 457
SEIFFERT, Forceps Tip 379
SELLHEIM, Instrument Obstetrical 467
SEMB, Bone Cutting Forceps 190
 Bone Holding Forceps 192
 Bone Rongeur 188
 Bronchus Clamp 399
 Periosteal Elevator 213
SEMKEN, Dressing Forceps 56, 60
SEMM, Vaginal Specula 436
SENN, Retractor 108
SENN-GREEN, Retractor 114
SEXTON, Ear Knife 324
SHEA, Micro Scissors 328
Shears, Plaster Cast 180-181
 Rib 390-391
SHERMANN, Bone Plates 265
 Screws 264
SIEBOLD, Gynecological Scissors 34
SIEGLE, Ear Speculum Pneumatic 319
SILVER, Chisels Plastics 354
 Silver Clips 269
SIMCOE, Suturing Cannula 313
SIMON, Abdominal Retractors 124
 Bone Curettes 200
 Uterus Scoops 458
SIMPSON, Obstetrical Forceps 464
SIMPSON-BRAUN, Obstetrical Forceps 464
SIMPSON-LUIKART, Obstetrical Forceps 465
SIMS, Uterine Curettes 459
 Rectal Speculum 428
 Vaginal Specula 439
 Uterine Sounds 449
 Uterine Depressor 449
 Uterine Dilator 444
 Uterus Scissors 34
SINGLEY, Grasping Forceps 63
SKENE, Tenaculum Forceps 445
Skin Retractors 111
Skin Straightening Plate 22
SLUDER-BALLENGER, Tonsillectomes 376
SMELLIE, Obstetrical Hook 467
 Obstetrical Perforator 470
SMILLIE, Menisectomes 221
SMITH, Eye Speculum 284
SMITH-BUIE, Rectal Spreader 429
SMITH-PETERSEN, Gouges 207
 Bone Nails 250
 Osteotomes 207
 Bone Plates 251
SMITH-US ARMY, Gauze Scissors 41
SMITHWICK, Clip Applying Forceps 268
 Nerve Hook 271
 Snare, Ear Polypus 326
 Nasal 349
 Tonsil 375
 Rectal Polypus 431
SNELLEN, Entropium Forceps 312
 Lens Scoops 295
 Solution Bowls 477-478
SOMER, Uterine Elevating Forceps 448
Sounds Uterines 449
Spatula, Abdominal 109
 Bladder 422
 Brain 274
 Cyclodialysis 296-297
 Iris 296

Laryngoscope 11-12
 Lung 397
 Plaster 141
 Specula, Ear 318-319
 Eye 284-285
 Nasal 340-342
 Rectal 428-429
 Vaginal 434-441
SPENCER, Ligature Scissors 39
SPENCER-WELLS, Hemostatic Forceps 78
 Spherical Burrs 231
 Splinter Forceps 64-65
 Sponge Holding Forceps 101-103
SPRATT, Bone Curettes 200
 Spreaders, Bladder Neck 421
 Cervical Spine 132
 Plaster 181
 Rectal 428-429
 Rib 392-396
 Thorax 125, 396
 Vaginal 434-441
SPURLING, Laminectomy Forceps 276
ST. MARTIN, Suture Forceps 310
STACKE, Ear Probe 141
STAUDE-MOORE, Tenaculum Forceps 445
ST.CLAIR-THOMSON, Adenoid Curettes 361
STEINMANN, Pins 234
 Sterilizing Trays 477
 Sterilizing Forceps 177
STERNBERG, Lip Retractor 365
 Stethoscopes 5
STEVENS, Iris Forceps 301
 Lens Hook 392
 Needle-Holder 157
 Tenotomy Scissors 30
STEVENSON, Eye Speculum 285
STIEGLITZ, Splinter Forceps 65
STILLE, Bone Chisels 205
 Bone Hand Drill 227
 Gouge 205
 Osteotomes 205
 Pedicle Clamp 92
 Plaster Cast Shears 180
 Rib Shear 390
 Thumb and Tissue Forceps 56, 60
STILLE-LISTON, Bone Cutting Forceps 191
STILLE-LUER, Bone Rongeurs 187-188
STILLE-RUSKIN, Bone Rongeur 187
STILLE-SHERMANN, Bone Hand Drill 227
STOCKMANN, Meatus Clamp 423
STONE, Closing Forceps 414
STONE-WATT, Intestinal Clamp 414
 Locking Ferrule 414
 Strabismus Scissors 30, 47
STRATTE, Needle-Holders 155, 161
STRAUSS, Meatus Clamp 423
 Rectoscope 429
 Stripper, Tendon 222
 Vein 141
STRUEMPEL, Ear Forceps 328
STRULLY, Neurosurgical Scissors 36
STRUYCKEN, Nasal Forceps 346
 Suture, Clip Set 176
 Needles 170-174
 Suturing Set in Metal Case 176
SWEET, Clip Applying Forceps 268
 Syringes 149, 322, 376

T

TABB, Sickle Knife 335
 Tampon Forceps 100
TARNIER, Cranioclast 470
 Obstetrical Forceps 466
TAYLOR, Hammers 6
 Spinal Retractor 220
TEALE, Vulsellum Forceps 447
TERSON, Capsular Forceps 308
THOMS-ALLIS, Intestinal Forceps 408
THOMS-GAYLOR, Biopsy Forceps 451
THOMSON-WALKER, Bladder Retractor 422
THOREK, Lung Scissors 37
THUDICHUM, Nasal Specula 340
TIECK-HALLE, Nasal Specula 341

Tightener 236
TILLEY, Ear Forceps 326
TISCHLER-MORGAN, Biopsy Specimen Forceps 453
TISCHLER-KEVORKIAN, Biopsy Specimen Forceps 455
 Tissue Forceps 59-61
TIVNEN, Tonsil Seizing Forceps 374
TOBOLD, Tongue Depressor 364
TOENNIS, Dissector 272
 Hemostatic Forceps 86
 Needle-Holders 156, 164
TOENNIS-ADSON, Neurosurgical Scissors 37
 Tongue Depressors 364
 Tongue Holding Forceps 81
 Tonsil, Hemostat 375
 Needles 376
 Scissors 31-32
 Seizing Forceps 374
 Snare 375
 Syringes 376
 Tonsillectomes 376
TOOK, Corneal Knife 288
TOTI, Drill 232
 Towel Forceps 98-99
TOWNSEND, Biopsy Specimen Forceps 453-454
TOWNSEND-KEVORKIAN, Biopsy Specimen Forceps 454
TOYNBEE, Ear Specula 318
 Tracheal, Dilators 386
 Tubes 387
 Tracheostomy Set 388
 Tractor 467
TRAUBE, Hammer 6
TRELAT, Vaginal Specula 436
 Trephines 314
 Trocars 145-148
TROELTSCH, Nasal Dressing Forceps 343
TROEMNER, Hammer 6
TROUSSEAU, Tracheal Dilator 386
TROUTMANN, Blade Breaker 18
 Colibri Iris Forceps 302
 Muscle Forceps 305
 Tubes 10
 Tubing Clamps 96
TÜBINGEN, Air Cannula 313
 Iris Forceps 305
 Tying Forceps 310
TUFFIER, Hemostatic Forceps 81
 Rib Spreader 395
 Tuning Forks 320-321
TURNBULL, Nail Nippers 474
TURREL, Rectal Biopsy Forceps 432
TYDING, Tonsil Snare 375
 Tonsil Seizing Forceps 374

U

UCKERMANN, Cotton Applicator 143
 Tracheostomy Trocar 386
ULRICH, Swab Forceps 100
 Umbilical, Cord Clamps 467
 Cord Scissors 35
 Universal Bandage Scissors 42, 49
 Diagnostic Set 3
 Handles 379
 Sterilizing Forceps 177
 Trocar 147
 Wire Scissors 41, 49
UNNA, Comedo Extractor 472
 Urethrotome 423
US-ARMY, Retractors 106
USA-MODELL, Plaster Spreader 181
 Umbilical Cord Scissors 35
 Forceps 56, 59

V

VAN BUREN, Sequester Forceps 197
 Dilating Bougies 425
VAN DOREN, Biopsy Forceps 451
VANNAS, Iridectomy Scissors 53
 Varifocal Ophthalmoscopes 3
 Vascular Scissors 32-33, 48
 Vein, Probes 141
 Strippers 141
VERBRUGGE, Bone Holding Forceps 196

Index

VERRES , Pneumoperitoneum Needle	148
VIENNA , Nasal Specula	341
VIRCHOW , Cartilage Knife	21
Skull Breaker	209
VOLKMANN , Bone Curettes	199, 202
Retractors	115
VOLTOLINI , Nasal Speculum	340
VON PETZ , Suturing Apparatus	417

W

WACHENFELDT , Clips	176
Clip Applying Forceps	175
WADSWORTH-TODD , Cautery	296
WAGENER , Ear Hooklet	325
WAGENER-MOSHER , Intubation Tubes	387
WAGNER , Laminectomy Forceps	277
Gum Scissors	40
WALLICH , Abortion Scoop	469
WALSHAM , Septum Straightening Forceps	359
WALTON , Bandage Scissors	42
Comedo Extractor	472
Foreign Body Gouges	291
WANGENSTEEN , Tissue Forceps	63
Needle-Holders	154, 162
WARTENBERG , Pin-Wheel	7
Watchmaker's Forceps	64
WATSON-CHEINE , Elevator	215
WEBER , Lens Scoops	295
WECKER , Iris Scissors	52
Iris Spatula	296
WEEK , Eye Speculum	284
WEIL-BLAKESLEY , Biopsy Forceps	346
WEITLANER , Retractors	127-128
WEITLANER-WULLSTEIN , Retractors	128
WELLS , Enucleation Scoop	296
WERTHEIM , Hysterectomy Forceps	94-96
Dissecting Scissors	34
WERTHEIM-CULLEN , Hysterectomy Forceps	94
WEST , Nasal Chisel	355
WESTCOTT , Iridectomy Scissors	52
Tendon Scissors	52
WESTON , Rectal Polypus Snare	431
WHEELER , Cyclodialysis Spatula	297
Discission Knife	288
WHITE , Tonsil Seizing Forceps	374
WHITEHEAD , Mouth Gag	367
WIEDER , Tongue Depressor	364
WIENER , Antrum Rasps	356
Iris Hook	292
WIGMORE , Plaster Saw	180
WILDE , Nasal Snare	349
Ear Polypus Snare	326
Ear Forceps	325
WILDER , Lachrymal Dilator	299
Lens Scoops	295
WILLET-MARTEL , Scalp Flap Forceps	80
WILLIAMS , Eye Speculum	285
Grasping Forceps	410
Screw Driver/Holder	240
WILLIGER , Bone Curettes	202
Hammer	210
Periosteal Elevator	212
WINTER , Placenta and Ovum Forceps	468
Stethoscope	5
Wire	236
Drills	240
Cutters	236
Cutting and Bending Forceps	236
Loops	295, 324, 326
WITTNER , Biopsy Forceps	452
WOLFF , Plaster Cast Breaker	181
WRIGLEY , Obstetrical Forceps	464
WULLSTEIN , Sickle Knife	335
WYLIE , Uterine Dilator	444

Y

YANKAUER , Aspiration Tube	10
Postnasal Speculum	341
YEOMAN , Rectum Biopsy Forceps	432
YOUNG , Boomerang Needle-Holder	167
Prostatic Forceps	420
Prostatic Retractor	420

Tongue Holding Forceps	365
------------------------	-----

Z

ZAUFAL-JANSEN , Bone Rongeur	186
ZENKER , Dissecting/Ligature Forceps	88
ZIEGLER , Capsulotomy Knife	288
Eye Speculum	285
Head Mirrors	4
Iris Knife	287
Lachrymal Dilators	299

E

A

Abaisse-langues 364
 Adenotome 362
ADLERKREUTZ, Pincés 62
ADSON, Ecarteurs 129
 Ecarteur 270
 Elévateurs 215
 Micro pincés 57, 61
 Pincés 57-58, 61-62
 Pincés 274
 Pincés gouges 186
 Pince hémostatique 83
 Porte-aiguilles 154
 Rongeur 186
 Tube d'aspiration 275
ADSON-BABY, Pince hémostatique 83
ADSON-BROWN, Pincés à dissection 62
AEBLI, Ciseaux cornéens 30
 Agrafes à suture 176
 en argent 417
 Aiguilles, à dissection 290
 à injections 149, 313
 à ligatures 166-168
 à ponction lombaire 148
 à suture 170-174
 pour amygdales 373
 pour corps étrangers 290
 pour sinus maxillaire 349
ALLAN-PARKS, Spéculum rectal 429
ALBEE, Fraises 231-232
 Alésioirs 237
ALEXANDER, Ciseaux-burins 203
 Gouges 203
 Pince à biopsie 452
 Rugines raspatoires 212
ALLIS, Pincés à intestins 408
ALLIS-ADAIR, Pince à intestins 408
ALLISON, Spatule pulmonaire 397
ALM, Ecarteurs 127
ALVIS, Curette à corps étrangers 291
 Amniotome 447
 Amputation, scie à 225
 coteaux à 20
 ecarteur à 224
ANDREW, Abaisse-langues 364
 Angiotribes 79
 Anses 295, 324, 326
 Anuscopes 430
 Appareil compressif complet 2
 à suture 417
ARCHER, Pince à echarde 65
ARLT, Anses 295
ARRUGA, Blépharostat 284
 Crochets 392
 Pincés capsulaires 309
 Porte-aiguilles 157, 164
 Protecteur 296
ASCH, Pince à redresser la cloison 359
 Aspirateur capsulaire 298
 Aspiration, tubes à 275
 Assourdisseur 321
AUFRIEHT, Ecarteur nasal 359
 Râpe nasal 356
 Autopsie, jeu d'instruments à 209
AUVARD, Spéculums vaginaux 440
AXENFELD, Curette à chalazion 295
AYER, Pincés à chalazion 312

B

BABCOCK, Pincés à intestins et tissus 409
BABINSKY, Marteau 6
BACKHAUS, Pincés à champs 98
BAGGISH, Pince à biopsie 455
BAILEY, Rapprocheur des côtes 396
BAILEY-GIBBON, Rapprocheur des côtes 396
BAINBRIDGE, Pincés hémostatiques 91
 Bâillons 369
BAKES, Sondes biliaires 404
BALFOUR, Ecarteurs abdominaux 136
BALLENGER, Couteaux mobiles 351
 Elevateur pour cloison 353
 Gouges 355

Pince pour amygdales 374
 Bandages, Ciseaux à 41-42, 49
 Bandes frontales 4
BANGERTER, Spatule à cyclodialyse 296
BARANY, Assourdisseur 321
BARBARA, Aiguilles 336
 Crochet 336
BARKAN, Couteau à goniotomie 289
BARNHILL, Couteau à végétations 361
BARR, Spéculum rectal 428
BARRAQUER, Colibri blépharostat 284
 Colibri pincés à iris 303
 Colibri ciseaux à iris 52
 Couteau pour kératoplastie 290
 Pince à épilation 315
 Pince à fixation 308
 Pince chambre antérieure 306
 Porte-aiguilles 158, 164
BARRAQUER-KATZIN, Pince à iris 302
BARRETT, Pince utérine 445
BARTON, Forceps 466
 Tracteur 466
BAUMGARTNER, Porte-aiguilles 153, 159
BEACHAM, Amniotome 447
BECKER, Cystotome 293
BECKMANN, Couteau à végétations 360
 Ecarteur 130
BECKMANN-EATON, Ecarteur 130
BEEBEE, Ciseaux à fils 41
BEER, Pince à épiler les cils 315
BEESON, Ecarteur à plâtre 181
BELLUCCI, Ciseaux micro 328
BENGOLEA, Pince hémostatique 82
BENNET, Levier à os 216
BERENS, Kératomes 286
BERGMANN, Ciseaux à bandages 41
 Scie à plâtres 180
BERKE, Pincés musculaires 306
BERLINER, Marteau à percussion 6
BERNHARD, Pince à champs 99
BERTILLON, Céphalometre 7
BEST, Pincés à intestins 413
BETHUNE, Costotome 390
BEUSE, Ciseaux dentée 32
BEYER, Pince emporte-pièce 348
 Pince gouge 186
BILL, Tracteur 467
BILLEAU, Anses auriculaires 324
BIRCHER-GANSKE, Davier porte-os 196
 Méniscotomes 221
BISHOP-HARMAN, Pincés à iris 304
 Bistouris, à duremère 21, 273
 à plastic nasale 350
 à muqueuse 350
 lame sterile 10
 manche metal 20-21
 Bistouris, manches de 16
BLAKE, Curette utérine 458
 Pincés à voies biliaires 402
 Blépharostats 284-285
BLOHMKE, Pince à préhension 374
BLOUNT, Ecarteur à genou 220
 Levier à os 219
BLUNT, Clips pour instruments à anneaux 178
BLUMENTHAL, Pincés gouges 187
BODENHAMMER, Spéculum rectal 428
BOEHLER, Clous 250
 Etriers à extencion 235
 Pincés coupantes à os 190
 Pincés gouges 187
BOERMA, Forceps 466
BOETTCHER, Ciseaux à amygdales 32
 Boîtes à aiguilles 476
 Boîtes pour stérilisation 477, 479
BONACCOLTO, Pincés à strabisme 303-304
BONN, Canules à irrigation 313
 Pincés à iris 305
BORCHARDT, Fraises 232
BOSE, Crochet trachéal 387
 Ecarteur trachéal 386
BOUCHERON, Spéculum auriculaire 319
 Bougies 425
BOWLES, Stéthoscope 5

- BOWMANN**, Aiguilles à dissection 290
 Blépharostat 284
 Couteau à dissection 287
 Stylet lacrymal 299
- BOYNTON**, Porte-aiguilles 157
- BOZEMANN**, Porte-aiguilles 161
 Pince à pansements 103
- BOZEMANN-DOUGLAS**, Pince à pansements 103
- BRAUN**, Cranioclaste 470
 Crochet à décapitation 470
 Dépresseur utérine 449
 Pince utérine 445
- BRAUN-STADLER**, Ciseaux à épisiotomie 35
- BREISKY**, Spéculums vaginaux 441
 Broches 227-228, 236
- BROWN-ADSON**, Pincés 62
- BRUENINGS**, Abaisse-langues 364
 Couteau pour cloison 351
 Embout pincés laryngienne 379
 Pince coupantes nasales 345
 Serre nœud amygdalien 375
 Spéculum auriculaires pneumatique 319
- BRUNETTI**, Burin spinal 209
- BRUNNER**, Conducteur bois artificiel 169
 Costotome 391
 Pincés à intestins 413
 Sonde conductrice 169
- BRUNS**, Ciseaux à bandes 42, 49
 Curettes tranchantes pour os 199-200
- BRYANT**, Pince à pansement 102
- BUCHWALD**, Abaisse-langues 364
- BUCK**, Curettes auriculaires 323
 Levier corps étrangers 327
 Marteau à percussion 6
- BUIE**, Tube d'aspiration 431
- BUMM**, Curettes utérines 461
- BUNGE**, Curette pour exentération 294
- BUNNEL**, Ecorcheur de tendons 230
 Perforateur à main 222
- BUNT**, Clips pour instruments à anneaux 178
- BURCH**, Fourchette à fixation 289
 Burins 203-209
- BURKE**, Pince à biopsie 453
- BUSCH**, Ciseaux à cordon ombilical 35
- C**
- Canule, à air 313
 amygdalienne 376
 à irrigation 313, 349
 à succion 275
 boutonée 313
 ophtalmique 313
 sinus maxillaire 349
 trachéale 387
- CARMALT**, Pincés à échardes 64
- CARPENTER**, Dissecteur amygdalien et énucléateur 372
- Casse-lames 18
- CASTANEDA**, Ecarteur 395
- CASTROVIEJO**, Blépharostat 285
 Casse-lames 18
 Ciseaux cornéens 53
 Ciseaux à iridectomie 53
 Compas marqueur 298
 Dilatateur lacrymal 299
 Kératomes 286
 Pince à fixation 307
 Pince à sutures 310
 Pince capsulaire 309
 Porte-aiguilles 158, 164
 Spatule à cyclodialyse 297
 Trépans 314
- Cautère 296
 Céphalomètre 7
- CHAPUT**, Pince hémostatique 81
- CHARRIERE**, Scie à amputation 225
- CHEATLE**, Pince à instruments 177
- CHERON**, Pince à pansements 102
- CHEVALIER-JACKSON**, Pincés laryngéaux 380
- CHILDE**, Pince pour bords de la plaie 175
- CINELLI**, Ciseau-burins 355
 Ciseaux, à amygdales 31-32
 à bandages 41-42, 49
 à cartilages 21
 à chirurgie 24-29, 36
 à cordon ombilical 35
 à dissection 36-37
 à duremère 21
 à épisiotomie 35
 à entérotomie 39
 à envies 474
 à fistules 36
 à gencives 40
 à incision 25
 à iridectomie 53
 à iris 29
 à ligatures 39
 à ongles 473
 à parametrium 34
 à plâtres 180
 à préparation 29, 34-36
 à résection 21
 à strabisme 30, 47
 à tendons 30
 à tenotomie 30
 cornéens 30, 52-53
 gynécologiques 34-35
 microchirurgicaux 51-54
 nasaux 29, 31-32
 neurochirurgicaux 36-37
 oculaires 51-53
 pulmonaires 37-38
 thoraciques 38
 tungstène 43-49
 universels à fil métallique 41-42, 49
 utérins 34
 vasculaires 32-33, 48
- Ciseau-burins, corps étrangers 291
 extirpations 291
 hémostatique 338
 pour plastique nasal 350-351
 Sternal 208
- CITELLI**, Pince emporte-pièces 348
- Clamps, bulldog atrauma 68-69
 pincés à bronches 87-88, 398-399
 pour conduit biliaire 92-93, 402
 pour cordon ombilical 467
 stomacale 408-414, 416
 urétrale 406
- CLAR**, Lampes frontales 4
- CLARK**, Blépharostat 284
- CLEVELAND**, Pincés gouges 184
 Clips aneurysma 279-281
 pincés pour 281
- Clous 244-250
- CLOWARD**, Ecarteurs 132
- COACKLEY**, Curettes pour sinus 360
 Trocart pour sinus maxillaire 147
- COLCLOUGH**, Pincés emporte-pièces 278
- COLLIER**, Porte-aiguilles 152
- COLLIN**, Clamp pour cordon ombilical 467
 Compas pelvimètre 468
 Dynamomètres 3
 Ecarteurs abdominaux 134
 Hystéromètre 449
 Marteau 210
 Pince à pansements 102
 Pince hémostatique 81
 Pince hystérolabe 448
 Pince pour agrafes 175
 Pince tire-langues 81
 Spéculums vaginaux 434
- COLLIN-HARTMANN**, Ecarteur 108
- COLLYER**, Compas pelvimètre 468
- COLVER**, Pincés à préhension d'amygdales 374
 Compas pelvimètre 468
 Compresseur pour amygdales 375
 Conducteur 169
- CONNIN-AMSLER**, Marqueur 298
- CONVERSE**, Bistouri à plastique nasale 350
- COOLEY**, Pince atrauma 66
- COOPER**, Aiguilles à ligatures 167
- CORDES**, Embouts de pincés laryngiennes 379
- CORWIN**, Compresseur pour amygdales 375
- CORYLLOS**, Costotome 390
 Ecarteurs thoraciques 125
- COS**, Pince à fil métallique 329
 Costotomes 390-391

Index

COTTLE , Bistouri pour plastique nasale	351
Ciseaux-burin	350, 353-354
Ciseaux nasal	31
Ecarteur	358
Périostotomes	352-353
Spéculum nasal	342
COTTLE-KATZANJIAN , Pince coupante à os	190
COTTLE-NEIVERT , Ecarteur double	358
Couteaux à amputation	20
à capsulotomie	288
à cartilages	21
à cataracte	286
à dissection	287-288, 290
à goniectomie	289
à incision	25
à iridectomie	287
à plastique nasale	350
à resection	21
à serpette	335
à végétations	376
auriculaire	323-324, 335
circulaire	335
cornéen	288
lobaire	335
pour kératoplastique	289-290
COXETER , Sonde prostatique	406
CRAFOORD , Ciseaux pulmonaire	38
Pince clamp bronchique	88
Cranioclaste	470
CREDO , Coupe-cors	473
CRILE , Ecarteur double	108
Pincés hémostatiques	72
Porte-aiguilles	156
CRILE-MURRAY , Porte-aiguilles	153, 159
CRILE-RANKIN , Pincés hémostatiques	73
CRILE-WOOD , Porte-aiguilles	153, 159
CRITCHETT , Blépharostat	284
Crochet, auriculaire	325, 335-337
à cataract	286
à décapitation	470
à duremère	270
à fistule	457
à iris	111
à muqueuse	111
à nerfs	270-271
à peau	111
à strabisme	291-291
boutonné	325
musculaire	138
pour lentille cristalline	292
obstétrique	467
tira-clous	239
traquéal	386-387
CRUTCHFIELD , Alésoir	269
Tracteur crânien	269
Cuiller, à calculs biliaires	403
à faux germes	469
à sécrétion	469
utérine tranchante	458
CULLER , Spatule pour l'iris	296
Curettes, auriculaires	323, 337
à biopsie utérine	458-461
à corps étrangers	291
à faux germes	469
pour aspiration	450
pour lupus	472
pour sinus	360
tranchantes	199-202
utérines	458-461
CUSCO , Spéculum vaginaux	435
CUSHING , Ecarteurs	113
Ecarteur à nerfs	270
Perforateur plat	228
Pince à dissection	57, 61
Pincés à laminectomie	276
Spatule cérébrale	274
CUZZI , Cuiller pour faux germes	469
Cystotome	293
CZERNY , Spéculum rectal	428

D

DANDY , Ciseaux neurochirurgicaux	37
Ecarteur à nerfs	270

Pince hémostatique	79
DARLING , Ecarteur	131
DARTIGUES , Pince histérolabe	448
DASTOOR , Aspirateur capsulaire	298
Pincés à strabisme	304
DAVIDSON , Ecarteur à scapula	126
DAVIEL , Curette à cataracte	294
DAVIS , Aiguille pour corps étrangers	290
Dissecteur	273
Pincés à stérilisation	177
DAVIS-BOYLE , Ouvre bouches	367
DAY , Crochet auriculaire	325
DEAN , Ciseaux à amygdales	31
Couteau à iridectomie	287
DEAVER , Ciseaux	25, 44
Ecarteurs	109-110
DE BAKEY , Bulldog clamps atrauma	68
Ciseaux vasculaires	32-33
Pincés atrauma	66
Porte-aiguilles	160
DEJERINE , Marteaux	6
DE LEE , Forceps obstétriques	464
DE MARTEL , Guide-scie	272
Pince pour le cuir chevelu	80
DE MARTEL-WOLFSON , Pincés à anastomosis	414
Pincés cerre-clamps	414
Porte clamps	414
DENHART , Ouvre bouches	366
Depresseurs, epiglottis	358
utérin	449
DERF , Porte-aiguilles	152, 159
Dermatome	22
DESCHAMPS , Aiguilles à ligatures	166
DESJARDINS , Clamp pour conduit biliaire	402
Cuiller calculs biliaires	403
Pince à calculs biliaires	92
Sondes à calculs biliaires	403
DESMARRES , Ecarteur paupière	113
Pincés à chalazion	312
DEUTSCHMANN , Couteau à cataracte	286
DE VILBISS , Pince crâniale	271
DEWEY , Forceps	466
Diagnostic, sets à	3, 11-13
Diamant, pince coup-fil	237
Diapasons	320-321
DIEFFENBACH , Serres-fines	69
DIETER , Pince coupe-mailet	330
DIETHRICH , Porte-aiguilles	164
Dilatateurs, lacrymal	299
trachéal	386
urétral	425
utérin	442-444
DINGMANN , Davier porte-os	197
Dissecteur	272-273
cornéen	288, 291
pour amygdales	372
pour sac lacrymal	295
Dissection, pincés à	55-58
DIX , Aiguille et ciseau-burin	291, 298
DOUGLAS , Trocart	147
DOYEN , Pince à intestins	410
Ciseaux gynécologiques	34
Ecarteurs abdominales	122
Fraises	231
Pince à champs	99
Pince à polypes utérins	448
Rugine costale	213
Sonde cannelée	141
Spéculum vaginaux	440
Tracteur pour fibromes	457
DOYEN-JANSEN , Ouvre bouches	366
DUBOIS , Ciseaux gynécologiques	35
DUPLAY , Pince utérine	445
DUPLEX , Stéthoscope	5
DUPUY-WEISS , Aiguille pour amygdales	373
DUVAL , Pincés	62
DUVAL-COLLIN , Pincés à dissection	62
Pince pour les tissus et intestins	409
Dynamomètres	3

E

Ecarteurs, abdominal	109, 122, 124
à duremère	111

à genou	220
à nerfs	270-271
à périnéorrhaphie	441
à plâtre	181
col de vessie	421
cystique	431
des lèvres	365
malléables	109
musculaire	138
nasal	358-359
piliaire	372
pour le palais	372
prostatique	420
racine de nerfs	270-271
rectal	429
thoracique	125
trachéal	386-387
uvulaire	372
vertébral	220
vésical	421-422
ECHLIN , Pince gouge	187
Élévateur, pour amygdales	372
pour la cloison	352
ELLIOT , Forceps	464
Tréphines	314
ELLIS , Gouge à corps étrangers	291
ELSCHNIG , Couteau cornéen	288
Pince à fixation	307
Pincés capsulaires	308-309
Spatule à cyclodialyse	297
Embouts	379
EMMET , Crochets à fistules	457
ENGEL , Scie à appareils plâtres	180
Enucléation, ciseaux à	30
EPENDORFER , Pince à biopsie	455-456
ESMARCH , Ciseaux à bandages	42
Couteau à plâtre	181
Etrier à extension	235
EVES , Serre-nœud pour amygdales	375
Extraction, à clous	235
crochet à clous	239

F

FARABEUF , Davier porte-os	192
Ecarteurs	106
Rugines	212
FARABEUF-LAMBOTTE , Davier porte-os	192
FARREL , Porte-coton	143
FAULKNER , Curettes tranchantes	360
FAURE , Pincés à biopsie utérine	451
Pincés à péritoine	95
FEHLAND , Pincés à intestins	413
FEILCHENFELD , Pincés à échardes	64
FERGUSON , Angiotribe	79
Cuiller à calculs biliaires	403
FERGUSON , Davier porte-os	192
FERRIS-SMITH , Pincés à laminectomie	277
Pince à dissection	60
FERRIS-SMITH-KERRISON , Pince emporte-pièce	278
Fils	236
FINOCHIETTO , Clamp bronchique	398
Ecarteurs des côtes	392-393
Porte-aiguilles	155, 162
FINOCHIETTO-BURFORD , Ecarteurs des côtes	393-394
FINSEN , Ecarteurs	127
FISCH , Décolleur	337
FISCHER , Pince à iris	302
FLEURANT , Trocart pour la vessie	147
FOERSTER , Pincés à éponges	101
Pincés à iris	301
FOMON , Ciseau-burin	354
Ciseaux nasal	31
Ecarteur aux ailes	358
Ecarteur aux orifices postérieurs	358
Râpes nasaux	357
Forceps	464-466
FORD-BOWLES , Stéthoscopes	5
FOREGGER , Laryngoscopes	12
FOX , Curettes pour lupus	472
FRAENKEL , Embout de pince laryngienne	379
Pincés à polypes laryngiens	378
Fraises	227-228, 231-232
FRANCESCHETTI , Trépan à kératomie	314

FRANCIS , Aiguille pour corps étrangers	290
FRANCKE , Lancette à prise de sang	3
FRANKLIN-SILVERMANN , Aiguille à ponction	149
FRAZIER , Crochet	111
Ecarteurs	135
Tubes d'aspiration	275
FREER , Bistouri à muqueuse	350
Ciseau-burin	353
Couteau pour la cloison	350
Élévateurs pour la cloison	352
Gouge	355
FRENZEL , Abaisse-langues	364
FRIEDMANN , Ecarteur à périnéorrhaphie	441
Pincés gouges	184
FRI TSCH , Ecarteurs	121
FRYKHOLM , Pince gouge	188
FUCHS , Pince capsular	309

G

GALLAHER , Râpe à os	357
GAUSS , Pince péricraneale	467
GELLHORN , Pince à biopsie	451
GELPI , Ecarteur périéneal	133
GEMINI , Pince à dissection	85
Gencives, ciseaux à	40
GERALD , Pincés à dissection	57, 61
GERSTER , Ecarteur pour daviers	198
GERZOG , Marteau	210
GIERTZ-STILLE , Costotome	391
GIGLI , Manche pour scie en fil métallique	272
GILL , Dissecteur	288
Pince à iris	302
GILL-ARRUGA , Pince capsulaire	308
GILL-HESS , Pincés à iris	302
GILLIES , Crochet	358
Pince à dissection	60
Porte-aiguilles avec ciseaux	157, 163
GLOVER , Clamps cardiovasculaire atrauma	68
GLUCK , Costotome	390
GOELET , Ecarteur double	108
GOLDSTEIN , Blépharostat	285
Goniomètre	7
GOOD , Ciseaux à amygdales	32
GODELL , Dilatateur utérin	444
GOSSET , Ecarteur abdominal	135
Gouges	203-209
GRADLE , Pince à épiler les cils	315
GRAEFE , Blépharostat	284
Couteau à cataracte	286
Crochets à iris	111
Crochets à strabisme	292
Curette à cataracte	294
Cystotome	287
Pince à dissection	62
Pincés à iris	300
Pincés à fixation	307
Scarificateur	287
GRAHAM , Ecarteur de nerfs	270
GRAVE , Spéculum vaginaux	434
GRAY , Clamp pour conduit biliaire	93
GREEN , Crochet pour la thyroïde	119
Dissecteur cornéen	291
Pincés à fixation	308
GREEN-ARMYTAGE , Pince clamp utérine	467
GREVEN , Pince à fil métallique	329
GROSS , Curette et crochet auriculaire	324
GROSS-MAIER , Pincés à pansements	100
GRUBER , Spéculum auriculaires	318
Guide, pour broches	229
GUTHRIE , Crochet double	111
GUTMANN , Cuiller à sécrétion	424
GUYON , Bougies dilatatrices	425
Mandrin pour sondes	424
Pince à pédicule rénal	93
GUYTON-LUNDSGAARD , Sclérotome	289

H

HABERER , Ecarteurs malléables	109
HAGLUND-STILLE , Ecarteur à plâtre	181
HAIGHT , Ecarteur	395
HAJEK-BALLENGER , Élévateur à cloison	353
HAJEK-CLAUS , Pincés pour sinus maxillaire	347

Index

HAJEK-KOFLER , Pince emporte-pièce	347
HALLE , Bistouri	273
Curettes à os	201
HALSEY , Porte-aiguilles	152, 159
HALSTEAD-MOSQUITO , Pincés hémostatiques	71
HANK , Dilatateurs utérins	444
HARRINGTON , Ecarteurs	109
Pince à bronches	398
HARTMANN , Abaisse-langues	364
Diapasons	320
Pincés auriculaires	326-327
Pincés coupantes nasaux	346
Pincés hémostatiques	70
Pincés à polypes nasaux	344
Sonde auriculaire	322
Spéculum auriculaires	318
HARTMANN-HALLE , Spéculum nasaux	340
HARTMANN-HOFFMANN , Pince auriculaire	328
HARTMANN-WULLSTEIN , Pince auriculaire	328
HAUGH , Dilatateurs utérins	329
HEANEY , Ecarteurs	124
Pincés à hystérectomie	95
Porte-aiguilles	154, 161
HEATH , Ciseaux à ligatures	39
HEBRA , Curette à chalazion	294
HEGAR , Dilatateurs utérins	442
HEGENBARTH , Pince porte agrafes	175
HEIFETZ , Spatule	274
HEISS , Pincés hémostatiques	83
HEISTER , Ouvre bouches	366
HENKE , Elévateur à amygdales	372
HENNIG , Ecarteur à plâtre	181
HERRICK , Pince à pédicule rénal	94
HESS , Pincés à iris	302
Pincés capsulaires	309
HEYMANN , Ciseaux nasal	31
HEYMANN-KNIGHT , Pince nasal	345
Pince coupante nasale	344
HEYWOOD-SMITH , Pince à polypes utérins	431
HIBBS , Ciseaux-burin	208
Gouges	208
Osteotomes	207
HIRSCHMANN , Anuscope	430
HOESEL , Porte-aiguilles	155
HOFER , Ecarteur piliaire	372
HOHMANN , Leviers à os	217-220
HOKE , Osteotome	205
HOLTH , Pince pour capsulotomie	298
HOPKINS , Couteau à plâtre	181
HORSLEY , Dissecteur	273
HOUSE , Curettes doubles + sondes de mesure	337
Sondes de mesure	338
HUBER , Manche universel	379
HUDSON , Perforateur complet	228
HUNTER , Pincés à échardes	64
HURD , Décolleur à amygdales	372
Hysteromètres	449

I

Impacteur et extracteur pour clous	239
INGE , Ecarteur vertébral	275
Instrument, plateau pour	480
Insufflateur	322
IOWA , Pince utérine	447
Iris, crochets à	111
pincés à	300-305
ciseaux à	29, 47, 52
couteaux à	287
ISRAEL , Ecarteur	120
ITARD , Sonde auriculaire	322
ITERTSON , Ecarteur trachéal	386
IVES-FANSLER , Anuscope	430

J

JACKSON , Canules trachéales	387
Ecarteur trachéal	386
Pince porte tampons	378
Spéculum vaginaux	439
JACOBS , Pincés utérins	447
JAEGER , Kératomes	286
Plaque à paupières	285

JAMESON , Crochets à strabisme	291
Pincés à strabisme	303
JAMISON , Porte-aiguilles	153, 161
JANSEN , Ecarteurs	127
Pince nasal	343
JARCHO , Pince utérine	446
JATHO , Pince nasopharyngienne coupante	359
JENNINGS , Ouvre Bouches	366
Jeu d'instruments à autopsie	209
Jeu de trachéotomie en boîte	388
JEWETT , Clous	251
JOBSON-HORNE , Porte Cotton	143
JOHNS-HOPKINS , Pince hémostatique	91
Serres-fines	69
JOHNSON , Porte-aiguilles	155
JONES , Pincés à champs	98
JOSEPH , Râpes nasaux	356, 358
Bistouri à plastique nasale	350
Ciseaux	29
Crochets à muqueuse	111
Lime à os	356
Périostotome	353
Scie nasale	358
JUDD-ALLIS , Pince à intestins	408
JUDD-MASSON , Ecarteur vésical	421
JUERS , Pince à fil métallique	329
JURASZ , Pincés à polypes laryngiens	378

K

KABIERSKE , Lance poudre	321
KALLMORGEN , Spéculum vaginaux	439
KALT , Porte-aiguilles	158
KALT-ARRUGA , Porte-aiguilles	158
KANE ,Clamp pour cordon ombilical	467
KAUPP , Ecarteur	127
KEITH , Aiguilles à suture	173
KELLY , Ciseaux gynécologiques	36
Ecarteurs	107, 124
Pincés hémostatiques	72
Pince à polyps utérins	448
Proctoscopes	430
KELLY-RANKIN , Pincés hémostatiques	72
Kératomes	286
KERN , Davier porte-os	193
KERRISON , Pince emporte-pièce	347
KEVORKIAN , Curettes à biopsie utérine	450
Pince à biopsie	452
KEVORKIAN-PACIFIC , Pince à biopsie utérine	453
KEY , Elévateurs	215
KEYES , Set de trépan cutanés	473
KIELLAND , Forceps	465
KIELLAND-LUIKART , Forceps	465
KILLIAN , Elévateur pour la cloison	352
Sonde à irrigation	349
Spéculum nasaux	341
KILLIAN-CLAUS , Septum Gouge	355
KILNER , Ciseaux	29, 47
Crochet à peau	472
KILNER-DOUGHTY , Ouvre bouches	367
KIRBY-ARTHUR , Pince à iris	304
KIRK , Marteau	210
KIRSCHNER , Broches	229
Ecarteurs abdominaux	137
Etrier à extension	235
Perforateur à main	229
Sonde conductrice	169
KLINKENBERGH-LOTH , Ciseaux thoraciques	38
KNAPP , Couteau à iridectomie	287
Curette à cataracte	295
Ecarteur	293
KNAPP-LUER , Pince à granulations du trachome	312
KNIGHT , Pincés coupantes nasaux	345
KNOWLES , Ciseaux à bandages	42
KOCHER , Ecarteurs	118-119, 122
Pincés hémostatiques	78
Pincés à intestins	411
Sonde à goitre	388
Spatule vésicale	422
KOENIG , Aiguille à suture	172
Sondes conductrices	169
KOERTE , Ecarteurs	121
KOGAN , Endospéculum	441
KONRICH , Boîtes filtre	479

KRAUSE , Embouts de pince laryngienne	379
Serre nœud	326
Nasal Snares	349
KRISTELLER , Spéculum vaginaux	436-438
KRONECKER , Aiguilles à ligature	167
KUENTSCHER , Alesoir pour le fémur	238-239
Chasse-clous	238-239
Clous	245-249
Extracteur de clous	238-239
Impacteur final	238-239
Perforateur	239-239
KUHNT , Rugine cornéenne	289

L

LABORDE , Dilatateur trachéal	386
LA FORCE , Adénotome	362
Instrument à corps étrangers	291
LAHEY , Clamps pour conduit biliaire	91
Ecarteur	114
Pincés à saisir le goître	388
LAMBERT , Pince à chalazion	312
LAMBOTTE , Davier porte-os	192-193
Ostéotomes	206
Rugines	212
Lames de bistouri stérile	17
Lampes frontales	4
de rechange	4
LANCASTER , Blépharostat	285
Lance poudre	321
LANDAU , Spéculum vaginaux	441
LANE , Davier porte-os	194
Lever pour modeler attelles	240
Pince à dissection	60
Pince à champs	99
Pince à saisir les attelles	240
Pince à saisir les vis	240
Pincés clamps stomacales	415
Tournevis	240
LANG , Curette et dissecteur pour sac lacrymal	295
LANGE , Embout de pince laryngienne	379
LANGENBECK , Couteau à résection	21
Davier porte-os	192
Doigtier	369
Ecarteurs	116-117
Élévateur	214
Rugine Raspatoire	212, 214
Scie à doigt	225
Laryngoscopes	11
LAWRENCE , Pince hémostatique	89
LEBSCHÉ , Ciseaux-burin sternal	208
LEGUEU , Ecarteur vésical	421
Spatule vésicale	422
LEKSELL , Pincés gouges	189
LEMPERT , Curettes à os	201
Élévateur	338
Pincés gouges	186
LERCHE , Pince à dissection	62
LERICHE , Pince hémostatique	82
LESTER , Pince à fixation	307
Lever, à corps étrangers	327
à os	216-220
pour abaissement de la tête	467
pour modeler attelles	240
LEVINSON , Aiguille pour corps étrangers	290
LEWIN , Davier porte-os	196
LEXER , Ciseaux	26, 45
Ciseaux-burin	205-206
Gouges	205-206
LEXER-BABY , Ciseaux	27, 45
LICHTWITZ , Aiguille pour sinus maxillaire	349
Trocart pour sinus maxillaire	147
Lien, métallique	198
Limes, à ongle	473
à os	222
LISTER , Pince à pansement	102
Ciseaux à bandages	41, 49
LISTER-BURCH , Blépharostat	285
LISTON , Couteau à amputation	20
Pince coupante à os	190
LISTON-KEY-HORSLEY , Pince coupante à os	191
LITTAUER , Ciseaux à ligatures	39
Pince à épiler	315
Pince auriculaire	326

Pince à polypes nasaux	344
LITTLE , Ecarteur	114
LLOYD , Impacteur/Extracteur	240
LORENZ , Ciseaux à bandages	42
LORNA , Pincés à champs	99
LOUTE , Tendeur serre-fil	236
LOVE , Ecarteur de racines de nerfs	271
Ecarteur uvulaire	372
LOVE-GRUENWALD , Pincés à laminectomie	276
LOVELACE , Pince hémostatique	80
Pince pulmonaire	397
LOWER , Clamp pour conduit biliaire	91
LOWMAN , Davier à os	198
LUBET-BARBON , Pince à polypes nasaux	344
LUC , Pincés coupantes nasaux	345
LUCAE , Diapason	321
Marteau	210
Pincés auriculaires	325
LUER , Canules trachéales	387
Pincés gouges	185
LUIKART , Forceps	465
LUIKART-BILL , Tracteur	467
LUNDSSGAARD , Sclérotome	288
LUNIATSCHEK , Obturateur à gaze	372
LURZ , Pince urétrale	406

M

MAGILL , Pince à introd. sondes	10
Mains en plomb	198
MAISONNEUVE , Uréthrotome	423
MALTZ , Râpe nasale	356
Manches, à piles pour laryngoscopes	13
de bistouris	16
pour miroirs laryngiens	380
universell	379
Marqueurs	298
MARSHIK , Pince à amygdales	374
Marteaux	6, 210-211
MARTIN , Compas pelvimètre	468
Hystéromètres	449
Pince à cartilage	197
MARTINI , Curettes doubles	202
MASSON , Porte-aiguilles	154, 162
MASTIN , Pince musculaire	388
MATHIEU , Ecarteurs doubles	106
Pincés à corps étrangers	423
Porte-aiguilles	156, 163
Spéculum rectal	428
MATSON , Rugine	214
MATSON-ALEXANDER , Rugine	214
MAUNDER , Bâillon en bois	369
MAYO , Clips pour instruments à anneaux	178
Ciseaux	26, 44
Cuiller à calculs biliaires	403
Sonde à calculs rénaux	406
MAYO-BLAKE , Pincés à calculs biliaires	402
MAYO-GUYON , Pince à pédicule rénal	92
MAYO-HEGAR , Porte-aiguilles	153, 160
MAYO-NOBLE , Ciseaux	27
MAYO-ROBSON , Pincés à intestins	412
MAYO-STILLE , Ciseaux	26, 45
McCULLOUGH , Pincés à strabisme	303
McDONALD , Élévateur double	215
McGEE , Crochets	336
Pince micro auriculaire	329
McGUIRE , Ciseaux cornéens	52
McINDOE , Ciseaux à cartilages	37
Pince	56
McINTOSH , Laryngoscopes	11
McIVOR , Ouvre bouches	367
McKENTY , Élévateur pour cloison	352
McKENZIE , Fraise	228
Pincés à poser clips	268
McLAUGHLIN , Plaques osseuses	251
McLEAN , Forceps	465
McLEAN-LUIKART , Forceps	465
McLEAN-TUCKER , Forceps	465
McLEAN-TUCKER-LUIKART , Forceps	465
McPHERSON , Pincés à ligatures	311
MEAD , Marteau	211
Pincés gouges	184
Mèches	227-228, 231
MEEKER , Pince hémostatique	89

Index

MELLINGER , Blépharostat	285
MELLINGER-AXENFELD , Blépharostat	284
MENGHINI , Aiguilles à biopsie	148
Méniscotomes	221
MERCEDES , Ecarteur thoracique	396
Mesure graduée	478
METZENBAUM , Ciseaux	27-28, 46-47
Porte-aiguilles	154
METZENBAUM-FINO , Ciseaux	28, 46
MEYERDING , Ecarteurs	114
MEYHOEFER , Curette à chalazion	293
MICHEL , Agrafes	176
Miroir postrhinoscopique	343
Pince à poser agrafes	175
Micro, ciseaux	51-54, 328, 330-331
pincés	64, 66, 328-330, 332-334
MIDDELDORPF , Ecarteurs	119
MIDDLETON-JANSEN , Pincés coupantes nasaux	348
MIKULICZ , Ecarteurs	123
Pince à péritoine	95
MILLIGAN , Dissecteur	272
MILLIN , Ecarteur col de vessie	421
Pince à capsule prostatique	420
Pince pour saisir lambeaux prostatiques	421
Pince porte-fil prostatique	421
Mini, clips Aneurysma	279
pince porte-clips	281
plaques petit fragments	264
vis à os	255
Miroirs, frontal	4
laryngiens	380
postrhinoscopique	343
MIXTER , Clamp pour le conduit biliaire	402
Pincés hémostatiques	89-90
Pince à calculs biliaires	92
MIXTER-BABY , Pincés hémostatiques	90
MIXTER-O'SHAUGNESSY , Pincés hémostatiques	90
MOD. BERLIN , Pincés sere-tubes	96
MOD. WIEN , Spekula nasaux	341
MOELTGEN , Goniomètre	7
MOLLISON , Ecarteur	131
MOORE , Cuiller à calculs biliaires	402
Perforateur à main	228
MOORFIELD , Pince à suture	310
Moteur à main, électrique	230
MOYNIHAN , Pince à champs	99
Pince clamp	92
Sonde à calculs biliaires	403
MUCK , Couteau à périoste	338
MUELLER , Blépharostat	285
MURDOCK , Blépharostat	284
MURPHY-LANE , Elévateur double	216
MUSEUX , Pince utérine	446
MYLES , Pincés coupantes nasaux	346
Myrte, stylets en feuille de	140

N

NABATOFF , Trousse à varices	141
NAEGELE , Forceps	464
NAGER , Ecarteur pour le palais	372
Nécessaire à diagnostic	3
NEFF , Méniscotomes	221
NEGUS , Pincés à amygdales	373
NEIVERT , Porte-aiguilles	152
NELSON , Aiguilles à ligature	167
Pince à dissection	63
Trocarts thoracique	147
Nerfs, crochets	270-271
ecarteurs	113
ciseaux à dissection	37
Neurochirurgie	268-274, 279-281
NORTHBENT , Ciseaux à ligature	39
NOTO , Pince à polypes utérins	448
NOVAK , Curette aspirante à biopsie	450
NOYES , Ciseaux à iris	52
Pince à polypes nasaux	344

O

O'CONNOR , Crochet à iris	292
O'SULLIVAN-O'CONNOR , Ecarteur abdominal	135
OCHSNER , Sondes à calculs biliaires	403

Trocarts thoraciques	148
OLDBERG , Pince à laminectomie	277
OLIVECRONA , Pince gouge	185
Scie en fil métallique	272
Spatule	274
OLIVECRONA-TOENNIS , Pince à poser les clips	268
OLLIER , Ecarteur	120
OLSEN-HEGAR , Porte-aiguilles	156-157, 163
Ophthalmoscopes	3
Ostéotomes	203-209
Otoscopie, set pour	3
Ouvre bouches	366-368
OVERHOLT , Rugines à périoste	214
OVERHOLT-GEISSENDOERFER , Pincés hémostatiques	84

P

Parametrium, Ciseaux	34
PARHAM , Lien métallique	198
Serre-liens	198
PARK , Blépharostat	285
PARKER , Bistouris fines	20
Ecarteur double	106
PARKER-LANGENBECK , Ecarteurs	106
PARTSCH , Ciseaux-burin	204
Gouges	204
PASSOW , Ciseau-burin hémostatique	338
PATON , Dissecteur cornéen	288
PAUFIQUE , Couteau pour kératoplastique	289
Pincés à ligatures	311
PAYR , Ecraseurs intestinaux	416
Sondes conductrices	169
PEAN , Pincés hémostatiques	73, 80
PEDERSON , Spéculums vaginaux	434
PEET , Pince à échardes	65
PELKMANN , Pince à pansements	102
Pelvimètres	468
PENFIELD , Dissecteurs	273
PENNINGTON , Pince hémostatique	80
Perce-crâne	470
PERCY , Ecarteur à amputation	224
Perforateurs à main	228-230
à ongles	226
électriques	230
PERTHES , Perforateur	232
PESTALOZZA , Curette à faux germes	469
PHANEUF , Pincés à péritoine	94
PIERCE , Trocarts pour sinus maxillaire	146
PIFFARD , Curette pour lupus	472
PINARD , Stéthoscopes	5
Pincés, à anastomose	400, 414
à biopsie	346
à biopsie utérine	451-456
à calculs biliaires	92-93
à calculs rénaux	405
à cartilages	197
à chalazion	312
à champs	98-99
à couper et plier le fil	236-237
à dissection	56-58
à échardes	64
à épilation	315
à éponges	100
à fermer	414
à fil métallique	236-237
à fixation	307-308
à hypophyse	274
à hystérectomie	94-95
à instruments	177
à intestins et tissu	408-414
à introduire des sondes	10
à iris	300-305
à laminectomie	276-278
à ligature	84-86
à ongles	474
à pansements	101-103
à pédicule rénal	92-94
à péritoine	94-95
à polypes nasaux	344
à polypes laryngiens	378-380
à polypes utérins	448
à poser clips	175, 269
à saisir le goitre	388
à saisir tissus	62-63, 408-409

à sequestres	197
à strabisme	303-304
à stérilisation	177
à suture	310-311
amygdalienne	373-374
auriculaires	325-326
atraumatique	66
bronchiques	87
Bulldog atrauma	68-69
capsulaire	308-309
craniale	80
coupante à os	190-191
coupante nasale	344-346
coupe-fil	237
coupe-maillet	330
embouts de	379
entropion	312
gouge	184-189
hémostatiques	67-96
hémorrhoidale	431
hystérolabe	448
musculaire	306
péricranienne	467
porte-tampons	378
pour le cuir chevelu	80
pulmonaire	397
pour agrafes	269
pour la chambre antérieure	306
pour le pénis	423
pour redresser la cloison	359
prostatique	420
rectus	432
serre-tubes	96
thoracique	86
tirelangues	81
tungstène	58
universelle	177
urétérale	406
utérins	445-448, 451-456, 467
vasculaire	56, 61, 68-69
PIPER , Forceps	466
PITHA , Bâillon en silicone	369
Plaque à doigts	263
à ostéosynthèse	251-265
à paupières	285
condyalaire	261
mini fragments	264
pour étendre la peau	22
Plâtre, écarteur à	181
ciseaux à	180
couteau à	181
pince à	181
scie électrique oscillante à	182
PLESTER , Couteau lobaire	335
Ecarteur	128
Plomb, main en	198
POLITZER , Aiguilles à paracentèse	323
Insufflateur complet	322
POOLE , Tubes d'aspiration	10
Porte-agrales	268
Porte-aiguilles	151-164
Porte-coton	143
POTTS-DE MARTEL , Ciseaux vasculaires	33
POTTS-SMITH , Ciseaux vasculaires	33, 48
Pincés à dissection	57-58, 61
PRATT , Ecarteur cystique	431
Pince hémostatique	80
Pince utérine	447
Spéculum rectal	428
PRESBYTERIAN-HOSPITAL , Serre-tubes	96
PRICE-THOMAS , Pincés clamps bronchiques	398
PRINCE , Ciseaux à amygdales	32
Pincés musculaires	306
Proctoscopes	430
PROVIDENCE-HOSPITAL , Pince hémostatique	73
Pudendus, aiguille pour anesthésie	149
PUTTI , Râpe à os double	222

Q

QUINBY , Ciseaux à gencives	40
QUINKE , Pneumopéritoineum cannule	149
QUIRE , Levier à corps étrangers	327

QUISLING , Marteau intranasal	211
--	-----

R

RADOLF , Pince à extraire ongles	226
RALK , Perforateur à main	230
Pince à échardes	65
RAMPLEY , Pince à éponges	101
RANDALL , Curette aspirante à biopsie	450
Pincés à calculs renaux	405
RANEY , Pince à poser et enlever pincés	269
Pince hémostatique pour cuir chevelu	269
Râpe à os	222
nasale	356-357
pour le sinus	357
Rapprocheur des côtes	396
RECAMIER , Curetes utérins	460
Récipients cylindriques	478
Règle graduée	7
REICHERT , Depresseur épiglottis	378
REINER , Couteau à plâtre	181
Seringues pour les oreilles	322
REVERDIN , Aiguilles à suture	168
Ecarteur abdominal	109
REYNOLDS , Ciseaux	29, 47
Rhachiotome	209
RICHARDSON , Ecarteurs	107
RICHARDSON-EASTMAN , Ecarteurs	107
RICHTER-HEATH , Pince pour agrafes	175
RIGBY , Ecarteur	133
ROBERTS , Pincés hémostatiques	87
ROCHESTER-CARMALT , Pincés hémostatiques	78
ROCHESTER-OCHSNER , Pincés hémostatiques	76
ROCHESTER-PEAN , Pincés hémostatiques	74
ROEDER , Pince à champs	98
ROGER , Élévateur pour la cloison	352
ROGGE , Pince à stérilisation	177
ROLLET , Ciseau à extirpation	291
Crochet à iris	292
Rondelles pour vis à ostéosynthèse	253, 256, 258
ROSE , Crochet trachéal	387
ROSEN , Aiguilles	336-337
Couteau circulaire	335
ROSENBERG , Embout de pince	379
ROSER-KOENIG , Ouvre bouches	366
ROUX , Ecarteurs	106, 108
ROUX-BABY , Ecarteur	108
ROWE , Pincés à désimpaction	369
Ruban métrique	7
RUBIN , Pince à cloison nasale	347
Rugine, à periost	214
cornéenne	289
costale	213
raspatoire	212
RUMEL , Pincés thoraciques	86
RUSKIN , Pincés gouges	186-187
RUSKIN-LISTON , Pince coupante pour os	190
RUSS. MODELL , Pince à tissu	62
RYDEL-SEIFFER , Diapason	321
RYDER , Porte-aiguilles	161

S

SAALFELD , Tire-comédons	472
SACHS , Dissecteur	272
Ecarteur de nerfs	271
SAENGER , Pince à faux germes	468
Salpingographe	457
SANVENERO , Ciseaux	28
SAROT , Clamp bronchique	87
Porte-aiguilles	155, 161
SATINSKY , Ciseaux thoraciques	38
Pincés à anastomose	400
SATO , Couteau cornéen	288
SATTERLEE , Scie à amputation	225
SAUERBRUCH , Boîte à aiguilles	476
Costotome	391
Ecarteurs	125
Pincés gouges	189
SAUERBRUCH-FREY , Costotome	391
SAWTELL , Pincés amygdaliennes	373
Scarificateur	287
SCHAEDEL , Pince à champs	98
SCHAMBERG , Tire-comédons	472

THOMS-ALLIS , Pince à intestins	408
THOMS-GAYLOR , Pince à biopsie	451
THOMSON-WALKER , Ecarteur vésical	422
THOREK , Ciseaux pulmonaires	37
THUDICHUM , Spéculum nasaux	340
TIECK-HALLE , Spéculum nasaux	341
TILLEY , Pince auriculaire	326
Tire-clous	239
Tire-comédons	472
Tire-veines	141
TISCHLER-MORGAN , Embout à pince à biopsie utérine	453
TISCHLER-KEVORKIAN , Pince à biopsie utérine	455
TIVNEN , Pince à préhension amygdalienne	374
TOBOLD , Abaisse-langues	364
TOENNIS , Dissecteur	272
Pincés hémostatiques	86
Porte-aiguilles	156, 164
TOENNIS-ADSON , Ciseaux neurochirurgicaux	37
Tonomètre	314
TOOK , Couteau cornéen	288
TOTI , Fraise	232
Tournevis	240-241
TOWNSEND , Pince à biopsie utérine	453-454
TOWNSEND-KEVORKIAN , Pince à biopsie utérine	454
TOYNBEE , Spéculum auriculaire	318
Tracteur	467
TRAUBE , Marteau	6
TRELAT , Spéculum vaginaux	436
Trépans	314
Trocart, abdominal	146
pour la vessie	147
sinus maxillaire	147
thoracique	148
trachéotomie	386
universel	146
TROELTSCH , Pincés nasaux	343
TROEMNER , Marteau	6
Trousse, à amputation	209
à diagnostic	3
à dilatation	442-444
à suture	176, 417
pour varices	141
TROUSSEAU , Dilatateur trachéal	386
TROUTMANN , Casse-lames	18
Colibri Pince à iris	302
Pincés à iris	305
Tubes, d'aspiration	10
TÜBINGEN , Canule à air	313
Pincés à iris	305
Pincés à ligature	310
TUFFIER , Ecarteur	395
Pince hémostatique	81
TURNBULL , Pince à ongles	474
TURREL , Pince à biopsie rectale	432
TYDING , Pince à préhension amygdalienne	374
Serre nœud	375

U

UCKERMANN , Porte-coton	143
Trocart à trachéotomie	386
ULRICH , Pince à tampons	100
Universal, Ciseaux à pansements	42, 49
Ciseaux coupe-fils	41, 49
Jeu à diagnostic	3
Manche	379
Trocart	146
UNNA , Tire-comédons	472
Uréthrotomes	423
US-ARMY , Ecarteur double paire	106
USA-MODELL , Ciseaux pour le cordon ombilical	35
Ecarteur à plâtre	181
Pincés à dissection	56, 59

V

VAN BUREN , Bougies dilatatrices	425
Pince à séquestres	197
VAN DOREN , Pince à biopsie utérine	451
VANNAS , Ciseaux à iridectomie	53
Varifocal Ophthalmoscope	3
VERBRUGGE , Daviers porte-os	196
VERRES , Aiguille à pneumopéritoine	148
VIENNA , Spéculum nasaux	341

VIRCHOW , Burin pour crâne	209
Couteau à cartilages	21
Vis à compression	253
à ostéosynthèse	253-258, 264
à spongieuse	258
corticale	257
dynamique à fémur	253
malléolaire	257-258
VOLKMANN , Curettes tranchantes	199, 202
Ecarteurs	115
VOLTOLINI , Speculum nasal	340
VON PETZ , Appareil à sutures	417

W

WACHENFELDT , Agrafes	176
Pince pour agrafes	175
WADSWORTH-TODD , Cautère	296
WAGENER , Crochet auriculaire	325
WAGENER-MOSHER , Tube auriculaire	287
WAGNER , Ciseaux à gencives	40
Pince à laminectomie	277
WALLICH , Cuiller à faux germes	469
WALSHAM , Pince à redresser la cloison	359
WALTON , Ciseaux à pansement	42
Gouge à corps étrangers	291
Tire-comédons	472
WANGENSTEEN , Pince à dissection	63
Porte-aiguilles	154, 162
WARTENBERG , Sensimètre	7
WATSON-CHEINE , Elévateur double	215
WEBER , Anses	295
WECKER , Ciseaux à iris	52
Spatule pour l'iris	296
WEEK , Blépharostat	284
WEIL-BLAKESLEY , Pincés coupantes nasaux	346
WEITLANER , Ecarteurs	127-128
WEITLANER-WULLSTEIN , Ecarteur	128
WELLS , Cuiller à enucléation	296
WERTHEIM , Ciseaux à préparation	34
Pincés à hystérectomie	94-95
WERTHEIM-CULLEN , Pincés à hystérectomie	94
WEST , Ciseau-burin nasal	355
WESTCOTT , Ciseaux à tendons	52
Ciseaux à iridectomie	52
WESTON , Serre nœud à polypes rectaux	431
WHEELER , Couteau à discision	288
Spatule à cyclodialyse	297
WHITE , Pincés à préhension amygdalienne	374
WHITEHEAD , Ouvre bouches	367
WIEDER , Abaisse-langues	364
WIENER , Râpes nasaux	356
Crochet à iris	292
WIGMORE , Scie à plâtre	180
WILDE , Pince auriculaire	325
Serre nœud auriculaire	326
Serre nœud nasal	349
WILDER , Anses	295
Dilatateurs lacrimaux	299
WILLET-MARTEL , Pince pour le cuir chevelu	80
WILLIAMS , Blépharostat	285
Pince pour les intestins	410
Tournevis	240
WILLIGER , Curettes doubles	202
Marteau	210
Rugine raspatoire	212
WINTER , Pince à faux germes	468
Stéthoscope	5
WITTNER , Pince à biopsie utérine	452
WOLFF , Pincés à plâtre	181
WRIGLEY , Forceps obstétriques	464
WULLSTEIN , Couteau à serpette	335
WYLIE , Dilatateur utérin	444

Y

YANKAUER , Spéculum pour le pharynx	341
Tube d'aspiration	10
YEOMAN , Pince à biopsie rectale	432
YOUNG , Boomerang porte-aiguilles	176
Ecarteur prostatique	420
Pince à saisir la prostate	420
Pince tire-langues	365

Z

ZAUFAL-JANSEN , Pince gouge	186
ZENKER , Pince à dissection et à ligatures	88
ZIEGLER , Blépharostat	285
Couteau à capsulotomie	288
Couteau à iridectomie	287
Dilatateurs lacrymaux	299
Miroir frontal.	4

Índice alfabético

A

Abaja-lenguas	364
Abre-bocas	366-368
Adenótomo	362
ADLERKREUTZ , Pinza de disección	62
ADSON , Elevadores	215
Elevador	270
Micro pinzas de disección	57, 61
Pinzas-gubias	186
Pinzas de disección	57-58, 61-62
Pinzas hemostáticas	83
Pinzas	274
Porta-agujas	154
Separadores	129
Tubos de aspiración	275
ADSON-BABY , Pinza hemostática	83
ADSON-BROWN , Pinzas de disección	62
AEBLI , Tijeras corneales	30
Agujas, de inyección	149, 313
de paracentesis	323
para amígdalas	373
para anestesia de pudendus	149
para biopsia del hígado	148
para catarata	290
para cuerpos extraños	290
para ligaduras	165-168
para neumoperitoneo	149
para punción lumbar	149
para suturas	170-174
para tomar sangre	3
ALLAN-PARKS , Espéculo rectal	429
ALBEE , Fresas	231-232
ALEXANDER , Cinceles	203
Gubias	203
Periostótomos	212
ALLIS , Pinza intestinal	408
ALLIS-ADAIR , Pinza intestinal	408
ALLISON , Espátula pulmonar	397
ALM , Separadores	127
ALVIS , Cureta para cuerpos extraños	291
Amigdalótomos	376
Amniótomo	447
Amputación, cuchillos para	20
retractor para	224
sierras para	225
ANDREW , Abaja-lenguas	364
Anoscopios	430
Aparato, de compresión	224
para suturas intestinales	417
Aproximadores para costillas	392-396
ARCHER , Pinzas para espinas	65
ARLT , Asas	295
ARRUGA , Blefaróstatos	284
Gancho para extracción	292
Pinzas capsulares	309
Porta-agujas	157, 164
Protector	296
Asas, auriculares	324
para amígdalas	375
para cierranudos	349
oculares	295
ASCH , Pinza para el tabique nasal	359
Aspirador capsular	298
AUFRIEHT , Raspa nasal	356
Separador nasal	359
Autopsia, juego de instrumentos	209
AUVARD , Espéculos vaginales	440
AXENFELD , Cucharilla para chalazión	295
AYER , Pinza para chalazión	312

B

BABCOCK , Pinzas intestinales	409
BABINSKY , Martillo	6
BACKHAUS , Pinzas de campo	98
BAGGISH , Pinza para biopsia uterina	455
BAILEY , Aproximador de costillas	396
BAILEY-GIBBON , Aproximador de costillas	396
BAINBRIDGE , Pinzas hemostáticas	91
BAKES , Sondas para cálculos biliares	404
BALFOUR , Separadores abdominales	136
BALLENGER , Cinceles para plástica nasal	355
Cuchillos para vegetaciones	351

Elevador para el tabique	353
Pinza para coger amígdalas	374
Bandejas para esterilizar instrumentos	478, 480
BANGERTER , Espátula para ciclodialisis	296
BARANY , Ensordecedor	321
BARBARA , Agujas	336
Ganchitos	336
BARKAN , Cuchillo para goniotomía	289
BARNHILL , Cuchillos para vegetaciones	361
BARR , Espéculo rectal	428
Barra de tracción	198
BARRAQUER , Blefaróstatos	284
Pinzas para iris	303
Tijera para iris	52
Cuchillos para queratoplastia	290
Pinza depilatoria	315
Pinza de fijación	308
Pinza para cámara anterior	306
Porta-agujas	158, 164
BARRAQUER-KATZIN , Pinza para iris	302
BARRETT , Pinza uterina	445
BARTON , Forceps obstétrico	466
Tractor para forceps obstétricos	466
BAUMGARTNER , Porta-agujas	153, 159
BEACHAM , Amniótomo	447
BECKER , Quistótomo	293
BECKMANN , Cuchillos para vegetaciones	360
Separador	130
BECKMANN-EATON , Separador	130
BEEBEE , Tijeras para hilos	41
BEER , Pinza depilatoria	315
BEESON , Separador para yesos	181
BELLUCCI , Tijeras microquirúrgicas	328
BENGOLEA , Pinzas hemostáticas	82
BENNET , Elevador para huesos	216
BERENS , Querátotomo	286
BERGMANN , Sierra para yesos	180
Tijera para vendajes	41
BERKE , Pinzas musculares	306
BERLINER , Martillo	6
BERNHARD , Pinza de campo	99
BERTILLON , Cefalómetro	7
BEST , Pinzas intestinales	413
BETHUNE , Costótomo	390
BEUSE , Tijera dentada	32
BEYER , Pinza-gubia	186
Pinza sacabocado	348
BILL , Tractor para forceps obstétricos	467
BILLEAU , Asas auriculares	324
BIRCHER-GANSKE , Meniscótomos	221
Pinza para huesos	196
BISHOP-HARMAN , Pinzas para iris	304
Bisturios, hojas desechables estériles	17
mangos para hojas	16
para duramadre	273
para mucosa	350
para plástica nasal	350
BLAKE , Curetas uterinas dobles	458
Pinzas para vesícula biliar	402
Blefaróstatos	284-285
BLOHMKE , Pinza para coger amígdalas	374
BLOUNT , Elevador para huesos	219
Separador para rodilla	220
BLUMENTHAL , Pinzas-gubias	185
BODENHAMMER , Espéculo rectal	428
BOEHLER , Clavos para huesos	250
Estribo de extensión	235
Pinza cortante para huesos	190
Pinzas-gubias	187
BOERMA , Forceps obstétrico	466
BOETTCHER , Tijera para amígdalas	32
Bombillas de repuesto	4, 13
BONACCOLTO , Pinzas para estrabismo	303-304
BONN , Cánula para aspiración	313
Pinza para iris	305
BORCHARDT , Fresas	232
BOSE , Gancho traqueal	387
Separador traqueal	386
BOUCHERON , Espéculo auricular	319
BOWLES , Estetoscopio	5
BOWMANN , Agujas para discisión	290
Blefaróstato	284
Cuchillo para discisión	287
Sondas lacrimales	299

BOYNTON , Porta-agujas	157
BOZEMANN , Porta-agujas	161
Pinza para pólipos	103
BOZEMANN-DOUGLAS , Pinza para pólipos	103
BRAUN , Cranioclasto	470
Depressor uterino	449
Gancho de decapitación	470
Pinza uterina	445
BRAUN-STADLER , Tijeras para episiotomía	35
BREISKY , Espéculos vaginales	441
BROWN-ADSON , Pinzas de disección	62
BRUENINGS , Abaja-lenguas	364
Cierranudos para amígdalas	375
Cuchillo para tabique nasal	351
Espéculo auricular neumático	319
Pinzas cortantes nasales	345
Punta de pinza laríngea	379
BRUNETTI , Cincels espinales	209
BRUNNER , Sonda conductora	169
Costótomo	391
Pinzas intestinales	413
BRUNS , Cucharillas cortantes	199-200
Tijeras para vendajes	42, 49
BRYANT , Pinza para tapones	102
BUCHWALD , Abaja-lenguas	364
BUCK , Curetas auriculares	323
Elevador para cuerpos extraños	327
Martillo de percusión	6
BUIE , Tubo de aspiración	431
Bujías dilatadoras	425
BUMM , Curetas uterinas	461
BUNGE , Cucharilla para exenteración	294
BUNNEL , Perforador a mano	230
Separador para tendones	222
BUNT , Clip para esterilizar instrumental con anillos	178
BURCH , Horquilla fijadora	289
BURKE , Pinza sacabocados	453
BUSCH , Tijera para cordón umbilical	35

C

Cajas, de cristal con tapa	477
de esterilización	476-477
Campo, pinzas para	98-99
Cánulas, de aire	313
para aspiración	275
para irrigación	313, 349
para punción	148
oftalmológicas	313
CARMALT , Pinzas para espinas	64
CARPENTER , Cuchillo y disecador para amígdalas	372
CASTANEDA , Separador para costillas	395
CASTROVIEJO , Blefaróstato	285
Compás para marcar	298
Dilatadores lacrimales	299
Espátulas para ciclodialísis	297
Pinzas capsulares	309
Pinzas de fijación	307
Pinzas para suturas	310
Porta-agujas	158, 164
Queratótomo	286
Rompe-hojas	18
Tijeras corneales	53
Tijeras de iridectomía	53
Trefinas corneales	314
Catarata, agujas para	290
cuchillos para	286
Cateter, para oídos	322
metales	426
para próstata	426
pinza para introducir	10
CHAPUT , Pinza hemostática	81
CHARRIERE , Sierra para amputación	225
CHEATLE , Pinzas para esterilización	177
CHERON , Pinza para pólipos	102
CHAVALIER-JACKSON , Pinzas para larínge	380
CHILDE , Pinzas para poner agrafes	175
Cierranudos, auriculares	326
nasales	349
para amígdalas	375
para pólipos rectales	431
Cinceles, espinales	209
hemostáticos	338

para cirugía plástica	350
para extirpación	291
para huesos	203-209
para tabique nasal	353
CINELLI , Cinceles	315
Cinta frontal	4
métrica	7
CITELLI , Pinza sacabocado	348
Clamps, Anastomosis	400, 414
bronquiales	87
Bronchus	87-88
Bulldog	68-69
Bulldog Atrauma	68
estomacal	408-414
para pedículo	90-95
para tubos	96
para vasos	68-69
umbilicales	467
uretrales	406
CLAR , Lámparas frontales	4
CLARK , Blefaróstato	284
Clavos para huesos	244-251
CLEVELAND , Pinzas-gubias	184
Clips, aneurisma	279-281
de plata	269
pinzas para poner	175, 268, 281
CLOWARD , Separadores	132, 275
COACKLEY , Cureta para seno maxilar	360
Trocar para seno maxilar	147
COLCLOUGH , Pinza sacabocados	278
COLLIER , Porta-agujas	152
COLLIN , Clamp umbilical	467
Dinamómetro	3
Espéculos vaginales	434
Histerómetros	449
Martillo	210
Pelvímetros	468
Pinza hemostática	81
Pinzas histerolabo	448
Pinzas para agrafes	268
Pinzas para pólipos	102
Pinza tira-lenguas	81
Separadores abdominales	134
COLLIN-HARTMANN , Separador	108
COLLYER , Pelvímetro	468
COLVER , Pinzas para coger amígdalas	374
Comedones, saca-	472
Compresión, aparato de	224
placas de	252
tornillos de	253
CONNIN-AMSLER , Marcador	298
CONVERSE , Bisturí para plástica nasal	350
COOLEY , Pinza atrauma	66
COOPER , Agujas para ligaduras	167
CORDES , Puntas de pinzas laríngeas	379
CORWIN , Compresor para amígdalas	375
CORYLLOS , Costótomo	390
Separadores torácicos	125
COS , Pinza para doblar hilos	329
Costótomos	392-396
COTTLE , Bisturios para plástica nasal	351
Cinceles para plástica nasal	350, 353-354
Especulos nasales	342
Periostótomos	352-353
Ganchos	358
Tijera nasal	31
COTTLE-KATZANJIAN , Pinza corta-huesos	190
COTTLE-NEIVERT , Separador doble	358
COXETER , Cateter prostático	426
CRAFOORD , Pinza clamp para bronquios	88
Tijeras pulmonares	38
Cranioclasto	470
CREDO , Corta-callos	473
CRILE , Pinzas hemostáticas	72
Porta-agujas	156
Separadores	108
CRILE-MURRAY , Porta-agujas	153, 159
CRILE-RANKIN , Pinzas hemostáticas	73
CRILE-WOOD , Porta-agujas	153, 159
CRITCHETT , Blefaróstato	284
CRUTCHFIELD , Perforador inicial	269
Tractor craneal	269
Cubetas	478, 480
Cucharas, para abortos	469

Índice alfabético

para cálculos biliares	403
para catarata	293-295
para saco lacrimal	295
para secreciones	424
Cucharillas, cortantes	199, 202
para chalazión	293-295
para enucleación	296
para exenteración	294
Cuchillos, auriculares	323-324, 335
corneales	288
para amputación	20
para capsulotomía	288
para cartílagos	21
para catarata	286
para cerebro	21
para discisión	287-288, 290
para goniotomía	289
para iridectomía	287
para queratoplastia	289-290
para tabique	351
Cuerpos extraños, agujas para	290-291
cinceles para	291
curetas para	291
elevadores para	327
CULLER , Espátula para iris	296
Curetas, aspiradoras	450
auriculares	323, 337
cortantes para huesos	199-202
dobles	202
para abortos	469
para biopsia	450
para lupus	472
uterinas	458-461
CUSCO , Espéculos vaginales	435
CUSHING , Espátulas cerebrales	274
Gancho para nervios	270
Perforador plano	228
Pinzas de disección	57, 61
Pinzas para laminectomía	276
Separadores	113
CUZZI , Cuchara para abortos	469
CZERNY , Espéculo rectal	428

D

DANDY , Pinza hemostática	79
Separador para nervios	270
Tijeras neuroquirúrgicas	37
DARLING , Separador	131
DARTIGUES , Pinza histerolabo	448
DASTOOR , Aspirador capsular	298
Pinza para estrabismo	304
DAVIDSON , Separador para escápula	126
DAVIEL , Cucharilla para catarata	294
DAVIS , Aguja para cuerpos extraños	290
Descolador para duramadre	273
Pinzas para esterilización	177
DAVIS-BOYLE , Abre-bocas	367
DAY , Gancho auricular	325
DEAN , Cuchillo para iris	287
Tijeras para amígdalas	31
DEAVER , Separadores	109-110
Tijeras	25, 44
DE BAKKEY , Clamps bulldog atrauma	68
Pinzas atrauma	66
Porta-agujas	160
Tijeras vasculares	32-33
DEJERINE , Martillos	6
DE LEE , Forceps obstétricos	464
DE MARTEL , Guía sierra	272
Pinza para pericráneo	80
DE MARTEL-WOLFSON , Pinza para anastomosis	414
Pinza para cerrar pinzas	414
Porta-clamps	414
DENHART , Abre-bocas	366
Depresores de lenguas	364
DERF , Porta-agujas	152, 159
Dermátomo	22
DESCHAMPS , Agujas para ligaduras	166
DESJARDINS , Clamps para conducto biliar	92
Cucharilla para cálculos biliares	403
Pinza para cálculos biliares	402
Sonda para cálculos biliares	403
DESMARRES , Pinzas para chalazión	312

Separadores para párpados	113
Destornilladores	240
DEUTSCHMANN , Cuchillo para catarata	286
DE VILBISS , Pinza para craneo	271
DEWEY , Forceps obstétrico	466
Diagnóstico, juegos para	3, 11-13
Diapasones	320-321
DIEFFENBACH , Serrafinas	69
DIETER , Pinza para cabeza del martillo	330
DIETHRICH , Porta-agujas	164
Dilatadores, lacrimales	299
traqueales	386
uretrales	425
uterinos	442-444
Dinamómetro	3
DINGMANN , Pinza para huesos	197
Disecadores, corneales	272-273, 288, 291
para saco lacrimal	295
DIX , Instrumento para cuerpos extraños	291, 298
DOUGLAS , Pinza depilatoria	315
Trocar	147
DOYEN , Espéculos vaginales	440
Estiletos acanalados	141
Fresas	231
Periostótomos costales	213
Pinzas intestinales	410
Pinza de campo	99
Pinza para pólipos uterinos	448
Separadores abdominales	122
Tijeras ginecológicas	34
Tira-buzón para fibromas	457
DOYEN-JANSEN , Abre-bocas	366
DUBOIS , Tijera ginecológicas	35
DUPLAY , Pinza uterina	445
DUPLEX , Estetoscópios	5
DUPUY-WEISS , Aguja para amígdalas	373
DUVAL , Pinza para tejidos	62
DUVAL-COLLIN , Pinza para agarrar	62
Pinza para tejidos	62

E

ECHLIN , Pinza-gubia	187
Elevadores, para amígdalas	372
para huesos	216-220
para tabique	352
ELLIOT , Forceps obstétricos	464
Trefinas	314
ELLIS , Gubia para cuerpos extraños	291
ELSCHNIG , Cuchillo corneal	288
Espátula para ciclodíalisis	297
Pinzas capsulares	308-309
Pinza para fijación	307
EMMET , Gancho para fístulas	457
Encías, tijeras para	40
ENGEL , Sierra para vendajes	181
Ensordecedor	321
EPPENDORFER , Pinza para biopsia uterina	455-456
Esclerótomos	289
Escofinas nasales	357
ESMARCH , Cuchillo para yeso	181
Tijeras para vendajes	42
Espátulas, abdominales	109
cerebrales	274
para ciclodíalisis	296-297
para iris	296
para vejiga	422
pulmonares	397
Espéculos, auriculares	318-319
nasales	340-342
rectales	428-429
vaginales	434-441
Especios, frontales	4
laríngeos	380
postrinoscopios	343
Esterilización, bandejas para	478, 480
cajas para	476-477
instrumentos para	177-178
tambores para	479
Estetoscópios	5
Estiletos	140-141
Estrabismo, tijeras para	30, 47
Estribos de extensión	235
EVES , Cierranudos para amígdalas	375

Extensión, estribos para	235
Extractores, para clavos	239
para comedones	472

F

FARABEUF , Pinzas para huesos	192
Periostótomos	212
Separadores	106
FARABEUF-LAMBOTTE , Pinza para huesos	192
FARREL , Porta-algodones	143
FAULKNER , Curetas cortantes	360
FAURE , Pinza para biopsia uterina	451
Pinza para peritoneo	95
FEHLAND , Pinzas intestinales	413
FEILCHENFELD , Pinzas para espinas	64
FERGUSON , Cuchara para cálculos biliares	403
Pinza clamps de presión progresiva	79
FERGUSON , Pinza para huesos	192
FERRIS-SMITH , Pinza para laminectomía	79
Pinzas de disección	60
FERRIS-SMITH-KERRISON , Pinza sacabocados	278
FINOCHIETTO , Clamp bronquial	398
Porta-agujas	155, 162
Separador costal	392-393
FINOCHIETTO-BURFORD , Separador costal	393-394
FINSEN , Separadores	127
FISCH , Descolador	337
FISCHER , Pinza para iris	302
FLEURANT , Trócar para la vejiga	147
FOERSTER , Pinzas para esponjas	101
Pinzas para iris	301
FOMON , Cinceles	354
Escofina nasal	357
Separador para alas	358
Separador para coanas	358
Tijera nasal	31
Forceps obstétricos	464-466
FORD , Estetoscopio	5
FORD-BOWLES , Estetoscopio	5
FOREGGER , Laringoscopios	12
FOX , Curetas para lupus	472
FRAENKEL , Pinza para pólipos laríngeos	378
Puntas de pinzas laríngeas	379
FRANCESCHETTI , Trépanos	314
FRANCIS , Aguja para cuerpos extraños	290
FRANCKE , Aguja para tomar sangre	3
FRANKLIN-SILVERMANN , Aguja para biopsia	149
FRAZIER , Ganchito para duramadre	111
Separador	135
Tubos de aspiración	275
FREER , Bisturí para mucosa	350
Cinzel para tabique nasal	353
Cuchillo para tabique nasal	350
Elevador para tabique nasal	352
Gubia	355
FRENZEL , Abaja-lenguas	364
Fresas	227-228, 231-232
FRIEDMANN , Pinzas-gubias	184
Separador para perineorrafia	441
FRITSCH , Separadores	121
FRYKHOLM , Pinza-gubia	188
FUCHS , Pinza capsular	309

G

GALLAHER , Lima para seno maxilar	357
Ganchitos, auriculares	325, 335-337
para iris	111, 292-293
para la mucosa	111
para la piel	111
Ganchos, abdominales	122, 124
cisticos	431
de decapitación	470
musculares	138, 291
para cristalino	292
para estrabismo	291-292
para extracción	239, 292
para fístulas	457
para nervios	270-271
para próstata	420
para tiroide	388
obstétricos	467
traqueales	386-387

GAUSS , Pinza para pericráneo	467
GELLHORN , Pinza para biopsia	451
GELPI , Separador perineal	133
GEMINI (Mixer) , Pinzas de disección y ligaduras	85
GERALD , Pinzas de disección	57, 61
GERSTER , Barra de tracción	198
GERZOG , Martillo	210
GIERTZ-STILLE , Costótomo	391
GIGLI , Mango para sierra de hilo	272
GILL , Disecador para la córnea	288
Pinza para iris	302
GILL-ARRUGA , Pinza capsular	308
GILL-HESS , Pinzas para iris	302
GILLIES , Ganchito fino	358
Pinza de disección	60
Porta-agujas con tijera	157, 163
GLOVER , Clamps cardiovascular atrauma	68
GLUCK , Costótomo	390
GOLET , Separador doble	108
GOLDSTEIN , Blefaróstato	285
Goniómetro	7
GOOD , Tijera para amígdalas	32
GOODELL , Dilatador uterino	444
GOSSET , Separadores abdominales	135
GRADLE , Pinza depilatoria	315
GRAEFE , Blefaróstatos	284
Cucharilla para cataratas	294
Cuchillo para cataratas	286
Escarificador	287
Ganchito para iris	111, 293
Gancho para estrabismo	292
Pinza de fijación	62
Pinzas para iris	300
Quistótomo	287
GRAHAM , Gancho para nervios	270
GRAVE , Espéculos vaginales	434
GRAY , Clamps para conducto biliar	93
GREEN , Disector corneal	291
Gancho muscular	291
Pinzas de fijación	308
GREEN-ARMYTAGE , Pinza clamp uterina	467
GREVEN , Pinza para doblar hilos	329
GROSS , Cureta y gancho auricular	324
GROSS-MAIER , Pinzas para pólipos	100
GRUBER , Espéculo auricular	318
Gubias, hemostáticas	338
nasales	351
para cuerpos extraños	291
para esternón	208
para huesos	203-209
para tabique	353
vertebrales	209
Guías	169
GUTHRIE , Ganchito doble	111
GUTMANN , Cuchara para secreciones	424
GUYON , Bujías dilatadoras	425
Mandril para catéteres	424
Pinza para pedículo renal	93
GUYTON-LUNDSGAARD , Esclerótomo	289

H

HABERER , Separadores maleables	109
HAGLUND-STILLE , Separador de yeso	181
HAIGHT , Separador costal	395
HAJEK-BALLENGER , Elevador para tabique	353
HAJEK-CLAUS , Pinza para seno maxilar	347
HAJEK-KOFLER , Pinzas sacabocados	347
HALLE , Bisturí	273
Cucharillas cortantes maleables	201
HALSEY , Porta-agujas	152, 159
HALSTEAD-MOSQUITO , Pinzas hemostáticas	71
HANK , Dilatador uterino	444
HARRINGTON , Pinzas bronquiales	398
Separadores	109
HARTMANN , Abaja-lenguas	364
Cateter auricular	322
Diapasones	320
Espéculos auriculares	318
Pinzas cortantes nasales	346
Pinzas hemostáticas	70
Pinza para pólipos nasales	344
HARTMANN-HALLE , Espéculos nasales	340

Índice alfabético

HARTMANN-HOFFMANN , Pinza auricular	328
HARTMANN-WULLSTEIN , Pinza auricular	328
HAUGH , Pinza auricular	329
HEANEY , Pinzas para histerectomía	95
Porta-agujas	154, 161
Separadores	124
HEATH , Tijera para ligaduras	39
HEBRA , Cucharilla para chalazión	294
HEGAR , Dilataores uterinos	442
HEGENBARTH , Pinza para agrafes	175
HEIFETZ , Espátula	274
HEISS , Pinzas hemostáticas	83
HEISTER , Abre-bocas	366
HENKE , Elevador para amígdalas	372
HENNIG , Separador para yesos	181
HERRICK , Pinza para pedículo renal	94
HESS , Pinzas capsulares	309
Pinzas para iris	302
HEYMANN , Tijera nasal	31
HEYMANN-KNIGHT , Pinza cortante nasal	345
Pinza nasal	344
HEYWOOD-SMITH , Pinza para pólipos uterinos	431
HIBBS , Cinceles	208
Gubias	208
Osteótomos	207
Hilos	236
HIRSCHMANN , Anoscopios	430
Histerómetros	449
HOESEL , Porta-agujas	155
HOFER , Separador para pilar	372
HOHMANN , Elevadores para huesos	217-220
Hojas de bisturí, estériles	17
HOKE , Osteótomos	205
HOLTH , Pinza para capsuloridectomía	298
HOPKINS , Cuchillo para yesos	181
HORSLEY , Disecador	273
HOUSE , Cucharillas cortantes	337
Sonda de medición	338
HUBER , Mango universal	379
HUDSON , Perforador a mano	228
HUNTER , Pinzas para espinas	64
HURD , Disecador para amígdalas	372

I

Impactor/Extractor para clavos	239
INGE , Separador vertebral	275
Insuflador	322
IOWA , Aguja para anestesia del pudendus	149
Pinza uterina	447
Iris, cuchillos para	287
espátulas para	296
ganchos para	111
pinzas para	300-305
tijeras para	29, 47, 52
ISRAEL , Separadores	120
ITARD , Cateter auricular	322
ITERSON , Gancho traqueal	386
IVES-FANSLER , Anoscopio	430

J

JACKSON , Especulos vaginales	439
Gancho traqueal	386
Pinza porta-tapones	378
Separador traqueal	386
Tubos traqueales	387
JACOBS , Pinzas uterinas	447
JAEGER , Placa para párpados	285
Queratótopo	286
JAMESON , Gancho para estrabismo	291
Pinzas para estrabismo	303
JAMISON , Porta-agujas	153, 161
JANSEN , Pinza nasal	343
Separadores	127
JARCHO , Pinza uterina	446
JATHO , Pinza cortante nasofaringeal	359
JENNINGS , Abre-bocas	366
Jeringas	149, 322, 376
JEWETT , Clavos para huesos	251
JOBSON-HORNE , Porta-algodones	143
JOHNS-HOPKINS , Pinza hemostática	91
Serrafinas	69
JOHNSON , Porta-agujas	155

JONES , Pinzas de campo	98
JOSEPH , Bisturí para plástica nasal	350
Ganchito para mucosa	111
Limas nasales	356, 358
Limas para huesos	356
Periostótomos	353
Sierra nasal	358
Tijeras	29
JUDD-ALLIS , Pinzas intestinales	408
JUDD-MASSON , Separador vesical	421
Juegos, de diagnóstico	2-3
de autopsia	209
de laringoscopia	11-13
de otoscopios	3
de traqueotomía	388
JUERS , Pinza para doblar hilos	329
JURASZ , Pinzas para pólipos laríngeos	378

K

KABIERSCHE , Lanza-polvo	321
KALLMORGEN , Especulos vaginales	439
KALT , Pinza capsular	308
Porta-agujas	158
KALT-ARRUGA , Porta-agujas	158
KANE , Clamp umbilical	467
KAUPP , Separador	127
KEITH , Aguja de sutura	173
KELLY , Pinzas hemostáticas	72
Pinzas para pólipos uterinos	448
Proctoscopios	430
Separadores	107, 124
Tijeras ginecológicas	36
KELLY-RANKIN , Pinzas hemostáticas	72
KERN , Pinzas para huesos	193
KERRISON , Pinzas sacabocados	347
KEVORKIAN , Cureta para biopsia uterina	450
Pinza para biopsia uterina	452
KEVORKIAN-PACIFIC , Pinza para biopsia uterina	453
KEY , Elevadores	215
KEYES , Juego de trefinas cutáneas	473
KIELLAND , Forceps obstétrico	465
KIELLAND-LUIKART , Forceps obstétrico	465
KILLIAN , Cánula de irrigación	349
Elevador para tabique nasal	352
Especulos nasales	341
KILLIAN-CLAUS , Gubia para tabique nasal	355
KILNER , Ganchito para piel	472
Tijeras para cirugía plástica	29, 47
KILNER-DOUGHTY , Abre-bocas	367
KIRBY-ARTHUR , Pinza para iris	304
KIRK , Martillo	210
KIRSCHNER , Estribo de extensión	235
Perforador con guía telescópica	229
Separador abdominal	137
Sonda conductora	169
Taladros filiformes	234
KLINKENBERGH-LOTH , Tijera torácica	38
KNAPP , Cucharilla para catarata	295
Cuchillos para iris	287
Separador	293
KNAPP-LUER , Pinza para tracoma	312
KNIGHT , Pinza cortante nasal	345
KNOWLES , Tijeras para vendajes	42
KOCHER , Espátulas vesicales	422
Pinzas hemostáticas	78
Pinzas intestinales	411
Separadores	118-119, 122
Sondas para bocio	388
KOENIG , Aguja para suturas	172
Sonda conductora	169
KOERTE , Separadores	121
KOGAN , Endoespéculo	441
KONRICH , Tambores para esterilización	479
KRAUSE , Cierranudos auriculares	326
Cierranudos nasales	349
Puntas de pinzas laríngeas	379
KRISTELLER , Especulos vaginales	436-438
KRONECKER , Aguja para ligaduras	167
KUENTSCHER , Clavos intramedulares	245-249
Dilatador para fémur	238-239
Extractor de clavos	238-239
Impactor de clavos	238-239

Punzón medular 238-239
KUHNT, Legra para la córnea 289

L

LABORDE, Dilatador traqueal 386
LA FORCE, Adenótomo 362
 Instrumento para cuerpos extraños 291
LAHEY, Pinza para conducto biliar 91
 Pinzas para agarrar bocio 388
 Separador 114
LAMBERT, Pinza para chalazión 312
LAMBOTTE, Pinzas para huesos 192-193
 Osteótomos 206
 Periostótomos 212
 Lámparas frontales 4
LANCASTER, Blefaróstató 285
LANDAU, Espéculos vaginales 441
LANE, Destornillador 240
 Elevador para doblar placas 240
 Pinzas de disección 60
 Pinzas clamps estomacales 415
 Pinza para sostener placas y tornillos 240
 Pinza de campo 99
 Pinza para huesos 194
LANG, Disecador para saco lacrimal 295
LANGE, Punta de pinza laríngea 379
LANGENBECK, Cuchillos de resección 21
 Dedales 369
 Elevador 214
 Periostótomo 212, 214
 Pinzas para agarrar huesos 192
 Separadores 116-117
 Sierra de dedos 225
 Laringoscopios 11-13
LAWRENCE, Pinza hemostática 89
LEBSCHÉ, Cíncel para esternón 208
 Legra para la córnea 289
LEGUEU, Espátula vesical 422
 Separador vesical 421
LEKSELL, Pinzas-gubias 189
LEMPÉRT, Cucharillas cortantes 201
 Elevador 338
 Pinzas-gubias 186
LERCHE, Pinza de disección 62
LERICHE, Pinza hemostática 82
LESTER, Pinza para fijación 307
LEVINSON, Aguja para cuerpos extraños 290
LEWIN, Pinza para huesos 196
LEWIS, Raspas nasales 356
LEXER, Cinceles 205-206
 Gubias 205-206
 Tijeras 26, 45
LEXER-BABY, Tijeras 27, 45
LICHTWITZ, Aguja de punción del seno maxilar 147
 Limas, nasales 356-357
 para huesos 222
 para uñas 473
LISTER, Pinza para tapones 102
 Tijeras para vendajes 41, 49
LISTER-BURCH, Blefaróstató 285
LISTON, Cuchillos para amputación 20
 Pinzas cortantes para huesos 190
LISTON-KEY-HORSLEY, Pinzas cortantes para huesos 191
LITTAUER, Pinza auricular 326
 Pinza depilatoria 315
 Pinza para pólipos nasales 344
 Tijeras para ligaduras 39
LITTLE, Separador 114
LLOYD, Extractor/Impactor 240
LORENZ, Tijeras para vendajes 42
LORNA, Pinza de campo 99
LOUTE, Tensor cierra-hilo 236
LOVE, Separador para úvula 271
 Separador para nervios 372
LOVE-GRUENWALD, Pinzas para laminectomía 276
LOVELACE, Pinza hemostática 80
 Pinzas para pulmones 397
LOWER, Pinza para conducto biliar 91
LOWMAN, Clamps para huesos 198
LUBET-BARBON, Pinza para pólipos nasales 344
LUC, Pinzas cortantes nasales 345
LUCAE, Diapasón 321
 Martillo 219

Pinzas auriculares 325
LUER, Pinzas-gubias 185
 Tubos traqueales 387
LUIKART, Forceps obstétrico 465
LUIKART-BILL, Tractor 467
LUNDGAARD, Esclerótomo 288
LUNIATSCHEK, Obturador de gaza 372
LURZ, Clamp uretral 406

M

MAGILL, Pinzas para introducir catéteres 10
MAISONNEUVE, Uretrótomo 423
MALTZ, Limas nasales 356
 Mandril para catéteres 424
 Mangos, de bisturíes 16
 de pilas para laringoscopios 13
 para espejos laríngeos 380
 universal 379
 Manos de plomo 198
 Marcadores 298
MARSCHIK, Pinza para amígdalas 374
 Martillos 6, 210-211
MARTIN, Histerómetro 449
 Pelvímetro 468
 Pinza para cartílagos 197
MARTINI, Curetas dobles 202
MASSON, Porta-agujas 154, 162
MASTIN, Pinza muscular 388
MATHIEU, Espéculo rectal 428
 Pinzas para cuerpos extraños 423
 Porta-agujas 156, 163
 Separadores 106
MATSON, Periostótomo 214
MATSON-ALEXANDER, Periostótomo 214
MAUNDER, Garrote de madera 369
MAYO, Clip para esterilización 178
 Cuchara para cálculos biliares 403
 Sondas para cálculos renales 406
 Tijeras 26, 44
MAYO-BLAKE, Pinzas para cálculos biliares 402
MAYO-GUYON, Pinza para pedículo renal 92
MAYO-HEGAR, Porta-agujas 153, 160
MAYO-NOBLE, Tijeras 27
MAYO-ROBSON, Pinzas intestinales 412
MAYO-STILLE, Tijeras 26, 45
McCULLOUGH, Pinzas para estrabismo 303
McDONALD, Elevador doble 215
McGEE, Ganchito 336
 Pinza para doblar hilos 329
McGUIRE, Tijera corneale 52
McINDOE, Tijeras para cartílagos 37
 Pinza de disección 56
McINTOSH, Laringoscopios 11
McIVOR, Abre-bocas 367
McKENTY, Elevador para tabique 352
McKENZIE, Perforador 228
 Pinzas para poner agrafes 268
McLAUGHLIN, Placas óseas 251
McLEAN, Forceps obstétrico 465
McLEAN-LUIKART, Forceps obstétricos 465
McLEAN-TUCKER, Forceps obstétrico 465
McLEAN-TUCKER-LUIKART, Forceps obstétricos 465
McPHERSON, Pinzas para ligaduras 311
MEAD, Martillo 211
 Pinzas-gubias 184
MEEKER, Pinza hemostática 89
MELLINGER, Blefaróstatos 285
MELLINGER-AXENFELD, Blefaróstatos 284
MENGHINI, Agujas para punción del hígado 148
 Meniscótomos 221
MERCEDES, Separador torácico 396
METZENBAUM, Porta-agujas 154
 Tijeras 27-28, 46-47
METZENBAUM-FINO, Tijeras 28, 46
MEYERDING, Separadores 114
MEYHOEFER, Cureta para chalazión 293
MICHEL, Espejos laríngeos 343
 Grapas 176
 Pinza para poner grapas 175
 Micro, pinzas 64, 66, 328-330, 332-334
 tijeras 51-54, 328, 330-331
MIDDELORPF, Separadores 119
MIDDLETON-JANSEN, Pinzas cortantes nasales 348

Índice alfabético

MIKULICZ , Pinza para el peritoneo	95
Separadores	123
MILLIGAN , Descolador	272
MILLIN , Pinza para cápsula	420
Pinza para ligaduras	421
Pinza para el lóbulo anterior	421
Separador para el cuello de la vejiga	421
Mini, clips aneurisma	279
pinza para poner clips aneurisma	281
Placas para fragmentos	264
Tornillos	255
MIXTER , Pinzas hemostáticas	89-90
Pinza para cálculos biliares	402
Pinza para el conducto biliar	92, 402
MIXTER-BABY , Pinzas hemostáticas	90
MIXTER-O'SHAUGNESSY , Pinzas hemostáticas	90
MOD. BERLIN , Pinza-clamps para tubos	96
MOD. WIEN , Espéculo nasal	341
MOELTGEN , Goniómetro	7
MOLLISON , Separador	131
MOORE , Cuchara para cálculos biliares	402
Perforador a mano	228
MOORFIELD , Pinza para suturas	310
Motor eléctrico con accesorios	230
MOYNIHAN , Pinza-clamp	92
Pinza de campo	99
Sonda para cálculos biliares	403
MUCK , Cuchillo para el periosteo	338
MUELLER , Bléfarostato	285
MURDOCK , Bléfarostato	284
MURPHY-LANE , Elevador para huesos	216
MUSEUX , Pinza uterina	446
MYLES , Pinzas cortantes nasales	346

N

NABATOFF , Juego para varices	141
NAEGELE , Forceps obstétricos	464
NAGER , Separador paladar	372
NEFF , Meniscótomos	221
NEGUS , Pinzas para amígdalas	373
NEIVERT , Porta-agujas	152
NELSON , Aguja para ligaduras	167
Pinza para agarrar	63
Trócar torácico	147
Neurocirugía	268-274, 279-281
NORTHBENT , Tijera para ligaduras	39
NOTO , Pinza para pólipos uterinos	277
NOVAK , Curetas aspiradora uterinas	450
NOYES , Pinza para pólipos nasales	344
Tijera para iris	52

O

O'CONNOR , Gancho para iris	292
O'SULLIVAN-O'CONNOR , Separador abdominal	135
OCHSNER , Sonda para cálculos biliares	403
Trócars torácicos	148
Oftalmoscópios	3
OLDBERG , Pinza para laminectomía	277
OLIVECRONA , Espátula	274
Pinza-gubia	185
Sierras de hilo	272
OLIVECRONA-TOENNIS , Pinza para poner agrafes	268
OLLIER , Separador	120
OLSEN-HEGAR , Porta-agujas	156-157, 163
Osteosíntesis	240-241
Osteotomos	203-209
Otoscopios	3
OVERHOLT , Periostótomos	214
OVERHOLT-GEISSENDOERFER , Pinzas hemostáticas	84

P

PARHAM , Cinta para huesos	198
Tensor de cintas	198
PARK , Bléfarostato	285
PARKER , Bisturíes	20
Separadores	106
PARKER-LANGENBECK , Separadores	106
PARTSCH , Cinceles	204
Gubias	204
PASSOW , Cíncel hemostático	338
PATON , Disecador corneal	288

PAUFIQUE , Cuchillo para queratoplástica	289
Pinzas para ligaduras	311
PAYR , Pinzas clamps intestinales	416
Sonda conductora	169
PEAN , Pinzas hemostáticas	73, 80
PEDERSON , Espéculos vaginales	434
PEET , Pinza para espinas	65
PELKMANN , Pinza para pólipos	102
Pelvímetros	468
PENFIELD , Disecador	273
PENNINGTON , Pinza hemostática	80
PERCY , Retractor para amputación	224
Perforadores, a mano	227-230
con guía telescópica	229
con mandril Jacobs	230
eléctrico	230
para uñas	226
PERTHES , Perforador	232
PESTALOZZA , Cureta para abortos	469
PHANEUF , Pinza para el peritoneo	94
PIERCE , Trócares para seno maxilar	146
PIFFARD , Curetas para lupus	472
PINARD , Estetoscópio	5
Pinzas, atrauma	66
auriculares	325
bronquiales	87-88, 398-399
capsulares	308-309
cierra-pinzas	414
cierra-tubos	96
corta-hilos	237
cortantes nasales	344-346
cortante para huesos	190-191
craneales	467
de campo	98-99
de disección	56-61
de fijación	307-308
depilatorias	315
de relojero	64
de tungsteno	58
gubias	184-189
hemostáticas	67-96
histerolabo	445-447
intestinales	408-414, 416
musculares	306
para aborto y placenta	468
para agarrar bocio	388
para anastomosis	400, 414
para biopsia	346
para biopsia uterina	451-456
para cálculos biliares	92-93
para cámara anterior	306
para chalazión	312
para coger amígdalas	374
para conducto biliar	402
para discos intervertebrales	278
para doblar hilos	236
para el pennis	423
para enderezar el tabique nasal	359
para espinas	64-65
para esponjas	100
para esterilizar instrumentos	177
para gastroscopía	382-384
para hemorroides	431
parra hipófisis	274
para histerectomía	94-95
para introducir catéteres	10
para iris	300-305
para laminectomía	276-278
para ligaduras	84-86
para mandíbulas	369
para pedículo renal	92-94
para peritoneo	94-95
para poner clips y grapas	175-269
para pólipos laríngeos	378-380
para pólipos nasales	344
para pólipos uterinos	448
para rectus	432
para sostener placas	240
para sostener tornillos	240
para sutura	310-311
para tejidos e intestinos	408-409
para uñas	474
porta-taponés	100-103
pulmonar	397

quirúrgicas	59-61
sacabocado para huesos	190-191, 276-278
tira-lenguas	365
torácica	86
uterinas	448, 451-456, 467
vasculares	58, 61, 68-69
PIPER , Forceps obstétricos	466
PITHA , Garrote de silicio	369
Placas para osteosíntesis	251-265
PLESTER , Cucharilla lobar	335
Separador	128
POLITZER , Aguja de paracentesis	323
Insuflador de aire	322
POOLE , Tubos de aspiración	10
Porta-agujas	151-164
Porta-aldones	143
POTTS-DE MARTEL , Tijeras vasculares	33
POTTS-SMITH , Pinzas de disección	57-58, 61
Tijeras vasculares	33, 48
PRATT , Espéculo rectal	428
Gancho cístico	431
Pinza hemostática	80
Pinza uterina	447
PRESBYTERIAN-HOSPITAL , Pinza-clamp para tubos	96
PRICE-THOMAS , Pinzas bronquiales	398
PRINCE , Pinzas musculares	306
Tijera para amígdalas	32
Proctoscopios	430
PROVIDENCE-HOSPITAL , Pinzas hemostáticas	73
Pudendus, aguja para anestesia	149
PUTTI , Limas para huesos	222

Q

QUINBY , Tijeras para encías	40
QUINKE , Cánula para neumoperitoneo	149
QUIRE , Elevador para cuerpos extraños	327
QUISLING , Martillo intranasal	211

R

RADOLF , Pinza para arrancar uñas	226
RALK , Perforador a mano	230
Pinza para espinas	65
RAMPLEY , Pinza para esponjas	101
RANDALL , Cureta aspiradora para biopsia uterina	450
Pinzas para cálculos renales	405
RANEY , Clips para cuero cabelludo	269
Pinza para poner clips	269
Raquiótomo	209
RECAMIER , Curetas uterinas	460
Rectoscopios	429
Reglas	7
REICHERT , Depresor para epiglotis	378
REINER , Cuchillo para yesos	181
Jeringas auriculares	322
Relojero, pinzas de	64
REVERDIN , Aguja para ligaduras	168
Separador abdominal	109
REYNOLDS , Tijeras para preparación	29, 47
RICHARDSON , Separador	107
RICHARDSON-EASTMAN , Separador	107
RICHTER-HEATH , Pinza para agrafes	175
RIGBY , Separador	133
Riñoneras	478
ROBERTS , Pinzas hemostáticas	87
ROCHESTER-CARMALT , Pinzas hemostáticas	78
ROCHESTER-OCHSNER , Pinzas hemostáticas	76
ROCHESTER-PEAN , Pinzas hemostáticas	74
ROEDER , Pinza de campo	98
ROGER , Elevador para el tabique	352
ROGGE , Pinza para esterilización	177
ROLLET , Cíncel para extirpación	291
Separador para iris	292
Rompe-cráneo	470
Rompe-hojas	18
ROSE , Gancho traqueal	387
ROSEN , Aguja	336-337
Cuchillo circular	335
ROSENBERG , Punta de pinza laríngea	379
ROSER-KOENIG , Abre-bocas	366
ROUX , Separadores	106, 108
ROUXBABY , Separadores	108
ROWE , Pinzas para mandíbulas	369

RUBIN , Pinza para magullar el tabique	347
RUMEL , Pinzas torácicas	86
RUSKIN , Pinzas-gubias	186-187
RUSKIN-LISTON , Pinzas cortantes para huesos	190
RUSS. MODELL , Pinzas de disección	62
RYDEL-SEIFFER , Diapasón	321
RYDER , Porta-agujas	161

S

SAALFELD , Extractor de comedones	472
SACHS , Descoladores	272
Gancho para nervios	271
SAENGER , Pinzas para aborto y placenta	468
Salpingógrafo	457
SANVENERO , Tijeras	28
SAROT , Pinzas bronquiales	87
Porta-agujas	155, 161
SATINSKY , Pinzas para anastomosis	400
Tijeras torácicas	38
SATO , Cuchillo corneal	288
SATTERLEE , Sierra para amputación	225
SAUERBRUCH , Caja para agujas	476
Costótomo	391
Pinzas-gubias	189
Separadores	125
SAUERBRUCH-FREY , Costótomo	391
SAWTELL , Pinza para amígdalas	373
SCHAEDEL , Pinza de campo	98
SCHAMBERG , Extractor de comedones	472
SCHUDE , Cucharillas cortantes	199
SCHIEE , Cánulas oftálmicas	313
Cuchillo para goniotomía	289
SCHHEINMANN , Puntas de pinzas laríngeas	379
SCHIMMELBUSCH , Tambores de esterilización	479
SCHINK , Dermátomo	22
SCHIOETZ , Tonómetro	314
SCHMIEDEN , Sonda conductora	169
SCHMIEDEN-PAYR , Sonda conductora	169
SCHMIEDEN-TAYLOR , Tijera para duramadre	37
SCHNIDT , Pinzas para amígdalas	373
SCHOENBORN , Separador para tiroide	388
SCHOENBURG , Pinza intestinal	410
SCHROEDER , Pinzas uterinas	445-446
SCHUBERT , Pinzas para biopsia uterina	451
SCHUKNECHT , Cuchillo circular	335
Cuchillo forma hoz	335
SCHULTZE , Salpingógrafo	457
SCHUMACHER , Pinza para biopsia uterina	452
Punta de pinza	379
Tijeras para cordón umbilical	35
SCHWEIGGER , Pinzas capsulares	309
SEDILLOT , Periostótomo	212
SEEMANN-SEIFFERT , Abre-bocas	366
SEOND , Bisturí para fibromas	457
SEIFFERT , Punta de pinza laríngea	379
SELLHEIM , Separador para salida de cabeza	467
SELLORS , Separador costal	396
SEMB , Periostótomo	213
Pinzas bronquiales	399
Pinza cortante para huesos	190
Pinza-gubia	188
Pinza para huesos	192
SEMKEN , Pinzas de disección	56, 60
SEMM , Espéculos vaginales	436
SENN , Separador	108
SENN-GREEN , Separador	114
Separadores, abdominales	109, 122, 124, 134-137
de labios y mejillas	365
maleables	109
nasales	359
para alas	358
para coanas	358
para costillas	392-396
para duramadre	270, 274
para nervios	113
para tendones	222
para raíz de nervios	271
para rodilla	220
para úvula	271
para yesos	181
perineal	133
rectal	428-429
torácicas	125

Índice alfabético

- traqueales 386-387
vaginal 434-441
vertebrales 275
vesicales 421-422
Serra-finas 68-69
SEXTON, Cuchillo auricular 324
SHEA, Tijera microquirúrgica 328
SHERMANN, Placas para huesos 265
Tornillos para huesos 264
SIEBOLD, Tijeras ginecológicas 34
SIEGLE, Espéculo auricular neumático 319
Sierras, circulares 226, 233
de hilo 272
eléctrica 182
nasales 358
para amputación 225
para anillos 226
para dedos 225
para vendajes enyesados 180, 182
SILVER, Cíncel para plástica nasal 354
SIMCOE, Cánula para sutura 313
SIMON, Cucharas uterinas 458
Cucharillas cortantes 200
Separadores abdominales 124
SIMPSON, Forceps obstétrico 464
SIMPSON-BRAUN, Forceps obstétricos 464
SIMPSON-LUIKART, Forceps obstétrico 465
SIMS, Curetas uterinas 459
Depresor uterino 449
Dilatador uterino 444
Espéculos vaginales 439
Espéculo rectal 428
Histerómetros 449
Tijeras para el útero 34
SINGLEY, Pinza para pulmones 63
SKENE, Pinza uterina 445
SLUDER-BALLENGER, Amigdalótomos 376
SMELLIE, Gancho obstétrico 467
Perforador obstétrico 470
SMILLIE, Meniscótomos 221
SMITH, Blefarróstato 284
SMITH-BUIE, Separador rectal 429
SMITH-PETERSEN, Gubias 207
Clavos para huesos 250
Osteótomos 207
Placas para huesos 251
SMITH-US ARMY, Tijeras para gaza 41
SMITHWICK, Gancho para nervios 271
Pinza para poner agrafes 268
SNELLEN, Asas 295
Pinzas para entropión 312
SOMER, Pinza histerolabo 448
Sondas, abotonadas 140-141
acanaladas 140-141
auriculares 141
conductoras 169
lacrimales 299
para bocio 388
para cálculos biliares 403-404
para cálculos renales 406
para várices 141
SPENCER, Tijeras para ligaduras 39
SPENCER-WELLS, Pinzas hemostáticas 78
SPRATT, Cucharillas cortantes 200
SPURLING, Pinzas para laminectomía 376
ST. MARTIN, Pinza para sutura 310
STACKE, Sonda auricular 141
STAUDE-MOORE, Pinza uterina 445
ST. CLAIR-THOMSON, Cuchillo para vegetaciones 361
STEINMANN, Clavos para huesos 234
STERNBERG, Separador de labios 365
STEVENS, Gancho para cristalino 292
Pinzas para iris 301
Porta-agujas 157
Tijeras para tenotomía 30
STEVENSON, Blefarróstato 285
STIEGLITZ, Pinza para espinas 65
STILLE, Cinceles 205
Cizallas para yesos 180
Costótomos 390
Gubias 205
Osteótomos 205
Perforador a mano 227
Pinza de disección 56, 60
Pinza para pedículo renal 92
STILLE-LISTON, Pinza cortante para huesos 191
STILLE-LUER, Pinzas-gubias 187-188
STILLE-RUSKIN, Pinza-gubia 187
STILLE-SHERMANN, Perforador a mano 227
STOCKMANN, Pinza para el pénis 423
STONE, Pinza para cerrar pinzas 414
STONE-WATT, Manguito de cierre 414
Pinza intestinal 414
STRATTE, Porta-agujas 155, 161
STRAUSS, Pinza para el pénis 423
Rectoscopio 429
STRUEMPEL, Pinza auricular 328
STRULLY, Tijeras neuroquirúrgicas 36
STRUYCKEN, Pinzas nasales 346
SWEET, Pinza para poner agrafes 268
- ### T
- TABB**, Cuchillo en forma de hoz 335
Taladros 227-228, 231
Tambores 479
TARNIER, Cranioclasto 470
Forceps obstétrico 466
TAYLOR, Martillos 6
Separador espinal 220
TEALE, Pinza uterina 447
Tensiómetros 2
TERSON, Pinza capsular 308
THOMS-ALLIS, Pinza intestinal 408
THOMS-GAYLOR, Pinza para biopsia uterina 451
THOMSON-WALKER, Separador vesical 422
THOREK, Tijeras pulmonares 37
THUDICHUM, Espéculos nasales 340
TIECK-HALLE, Espéculos nasales 341
Tijeras, auriculares 328, 330-321
corneales 30, 52-53
cuticulares 473
de disección 36-37
de iridectomía 53
de tungsteno 43-49
ginecológicas 34-35
microquirúrgicas 51-54
nasales 29, 31-32
neuroquirúrgicas 36-37
para amígdalas 31-32
para cartílagos 21, 37
para cirugía plástica 29
para cordón umbilical 35
para duramadre 21, 37
para el útero 34
para encías 40
para enterotomía 39
para episiotomía 35
para estrabismo 30, 47
para fístulas 36
para incisiones 25
para iris 29, 47
para ligaduras 39
para parametrio 34
para preparación 29, 36-38
para tenotomía 30
para uñas 473
para vendajes 41-42, 49
pulmonares 37-38
quirúrgicas 24-29, 36
torácicas 38
universales 42, 49
vasculares 32-33, 48
TILLEY, Pinza auricular 326
Tirabuzón 457
TISCHLER-MORGAN, Pinza para biopsia uterina 453
TISCHLER-KEVORKIAN, Pinza para biopsia uterina 455
TIVNEN, Pinza para coger amígdalas 374
TOBOLD, Abaja-lenguas 364
TOENNIS, Descolador 272
Pinzas hemostáticas 86
Porta-agujas 156, 164
TOENNIS-ADSON, Tijeras neuroquirúrgicas 37
Tonómetro 314
TOOK, Cuchillo corneal 288
Tornillos para huesos 253-258, 264
TOTI, Fresa 232
TOWNSEND, Pinza de biopsia uterina 453-454

TOWNSEND-KEVORKIAN , Pinza de biopsia uterina	454
TOYNBEE , Espéculos auriculares	318
Traqueotomía, juego de	388
TRAUBE , Martillo	6
Trefinas	314
TRELAT , Espéculo vaginal	436
Trépanos	227-230
Trocars	146-148
TROELTSCH , Pinzas nasales	343
TROEMNER , Martillo	6
TROUSSEAU , Dilatador traqueal	386
TROUTMANN , Colibri Pinza para iris	302
Pinza para iris	305
Rompe-hojas	18
Tubos, de aspiración	10
de extensión	379
de punción	148
traqueales	387
TÜBINGEN , Cánulas para aire	313
Pinza para iris	305
Pinza para ligaduras	310
TUFFIER , Pinza hemostática	81
Separador para costillas	395
TURNBULL , Pinzas para uñas	474
TURREL , Pinza de biopsia rectal	432
TYDING , Cierra-nudos	375
Pinza para coger amígdalas	374

U

UCKERMANN , Porta-algodón	143
Trócar	386
ULRICH , Pinzas para tapones	100
Uñas, limas para	473
perforador para	226
pinza para	474
tijeras para	473
Universal, Juego de diagnóstico	3
Mango	379
Pinza para esterilización	177
Tijeras de vendajes	42, 49
Tijeras para hilos	41, 49
Trócars	147
UNNA , Extractor de comedones	472
US-ARMY , Separador	106
USA-MODELL , Pinzas de disección	56, 59
Tijera para el cordón umbilical	35

V

VAN BUREN , Pinza para secuestros	197
Bujías dilatadoras	425
VAN DOREN , Pinza para biopsia uterina	451
VANNAS , Tijeras para iridectomía	53
Varifocal oftalmoscopio	3
Vendajes, tijeras para	42, 49
VERBRUGGE , Pinzas para huesos	196
VERRES , Aguja de neumoperitoneo	148
VIENNA , Espéculo nasal	341
VIRCHOW , Cuchillo para cartilago	21
Rompe-cráneo	209
VOLKMANN , Cucharillas cortantes	199, 202
Separadores	115
VOLTOLINI , Espéculos nasales	340
VON PETZ , Aparato para suturas	417

W

WACHENFELDT , Agrafes	176
Pinza para agrafes	175
WADSWORTH-TODD , Cauterio	296
WAGENER , Ganchito auricular	325
WAGENER-MOSHER , Tubo salvavidas	287
WAGNER , Pinza para laminectomía	277
Tijeras para encías	40
WALLICH , Cuchara para abortos	469
WALSHAM , Pinza para enderezar el tabique nasal	359
WALTON , Extractor de comedones	472
Gubia para cuerpos extraños	291
Tijera para vendajes	42
WANGENSTEEN , Pinza de disección	63
Porta-agujas	154, 162
WARTENBERG , Sensímetro	7
WATSON-CHEINE , Elevador	215

WEBER , Asas	295
WECKER , Espátula para iris	296
Tijeras para iris	52
WEEK , Blefaróstató	284
WEIL-BLAKESLEY , Pinzas cortantes nasales	346
WEITLANER , Separadores	127-128
WEITLANER-WULLSTEIN , Separador	128
WELLS , Cuchara para enucleación	296
WERTHEIM , Pinzas para histerectomía	94-95
Tijeras para preparación	34
WERTHEIM-CULLEN , Pinzas para histerectomía	94
WEST , Cíncel nasal	355
WESTCOTT , Tijera para iridectomía	52
Tijera para tendones	52
WESTON , Cierranudo para pólipos rectales	431
WHEELER , Cuchillo para discisión	288
Espátula de ciclodíalisis	297
WHITE , Pinzas para coger amígdalas	374
WHITEHEAD , Abre-bocas	367
WIEDER , Abaja-lenguas	364
WIENER , Limas nasales	356
Gancho para iris	292
WIGMORE , Sierra para yesos	180
WILDE , Cierranudo auricular	326
Cierranudo nasal	349
Pinzas auriculares	325
WILDER , Asas	295
Dilatador lacrimal	299
WILLET-MARTEL , Pinza para pericráneo	80
WILLIAMS , Blefaróstató	285
Destornillador	240
Pinza intestinal	410
WILLIGER , Cucharillas cortantes	202
Martillo	210
Periostótomo	212
WINTER , Estetoscopio	5
Pinzas para aborto y placenta	468
WITTNER , Pinza para biopsia	452
WOLFF , Pinzas para romper yesos	181
WRIGLEY , Forceps obstétrico	464
WULLSTEIN , Cuchillo en forma de hoz	335
WYLIE , Dilatador uterino	444

Y

YANKAUER , Espéculo laríngeo	341
Tubo de aspiración	10
YEOMAN , Pinza de biopsia rectal	432
Yesos, cizallas para	180
separadores para	181
sierras para	180, 182
YOUNG , Porta-agujas Boomerang	167
Pinza para sacar la prostata	420
Pinza tira-lenguas	365
Separador prostático	420

Z

ZAUFAL-JANSEN , Pinza-gubia	186
ZENKER , Pinza hemostática y de disección	88
ZIEGLER , Blefaróstató	285
Cucharilla de capsulotomía	288
Cucharilla de iridectomía	287
Dilatadores lacrimales	299
Espejos frontales	4

Nummernverzeichnis
Index of Numbers
Index des numéros de références
Indice de números de referencias

01	02-2050.37..... 13	04-1120.14..... 24	04-1264.23..... 44	04-1337.20..... 46
01-1010.00..... 2	02-2051.01..... 13	04-1120.15..... 24	04-1265.14..... 44	04-1337.23..... 46
01-1109.00..... 2	02-2051.02..... 13	04-1120.16..... 24	04-1265.17..... 44	04-1337.25..... 46
01-1110.00..... 2	02-2055.01..... 13	04-1120.18..... 24	04-1265.23..... 44	04-1337.28..... 46
01-1111.00..... 2	02-2056.00..... 13	04-1120.20..... 24	04-1270.15..... 26	04-1338.12..... 28
01-1112.01..... 3		04-1121.10..... 24	04-1270.17..... 26	04-1341.18..... 28
01-1112.02..... 3	03	04-1121.11..... 24	04-1271.15..... 26	04-1345.18..... 47
01-1113.00..... 3	03-0100.03..... 16	04-1121.13..... 24	04-1271.17..... 26	04-1350.14..... 28
01-1114.00..... 3	03-0100.13..... 16	04-1121.14..... 24	04-1274.15..... 45	04-1351.14..... 28
01-1200.00..... 3	03-0102.04..... 16	04-1121.15..... 24	04-1274.17..... 45	04-1352.14..... 29
01-1210.00..... 3	03-0102.14..... 16	04-1121.16..... 24	04-1275.15..... 45	04-1353.14..... 29
01-1220.00..... 3	03-0103.07..... 16	04-1121.18..... 24	04-1275.17..... 45	04-1360.12..... 29
01-1300.90..... 4	03-0103.17..... 16	04-1121.20..... 24	04-1280.17..... 27	04-1360.15..... 29
01-1300.91..... 4	03-0104.08..... 16	04-1122.14..... 43	04-1281.17..... 27	04-1364.12..... 47
01-1300.92..... 4	03-0105.10..... 17	04-1122.16..... 43	04-1300.16..... 26	04-1364.15..... 47
01-1310.00..... 4	03-0105.11..... 17	04-1123.14..... 24	04-1300.21..... 26	04-1370.15..... 29
01-1310.01..... 4	03-0105.12..... 17	04-1123.16..... 24	04-1301.16..... 26	04-1371.15..... 29
01-1312.00..... 4	03-0105.13..... 17	04-1130.10..... 24	04-1301.21..... 26	04-1374.15..... 47
01-1312.01..... 4	03-0105.14..... 17	04-1130.11..... 24	04-1304.16..... 45	04-1375.15..... 47
01-1312.06..... 4	03-0105.15..... 17	04-1130.13..... 24	04-1304.21..... 45	04-1380.09..... 29
01-1400.00..... 5	03-0105.16..... 17	04-1130.14..... 24	04-1305.16..... 45	04-1380.11..... 29
01-1402.00..... 5	03-0105.17..... 17	04-1130.15..... 24	04-1305.21..... 45	04-1381.09..... 29
01-1403.00..... 5	03-0106.12..... 17	04-1130.16..... 24	04-1310.10..... 27	04-1381.11..... 29
01-1404.00..... 5	03-0106.15..... 17	04-1130.18..... 24	04-1311.10..... 27	04-1384.11..... 47
01-1405.00..... 5	03-0112.18..... 17	04-1130.20..... 24	04-1314.10..... 45	04-1385.11..... 47
01-1406.00..... 5	03-0112.19..... 17	04-1131.10..... 24	04-1315.10..... 45	04-1391.09..... 30
01-1500.17..... 6	03-0112.20..... 17	04-1131.11..... 24	04-1320.14..... 27	04-1393.09..... 30
01-1500.20..... 6	03-0112.21..... 17	04-1131.13..... 24	04-1320.15..... 27	04-1393.11..... 30
01-1504.16..... 6	03-0112.22..... 17	04-1131.14..... 24	04-1320.18..... 27	04-1395.11..... 30
01-1510.22..... 6	03-0112.23..... 17	04-1131.15..... 24	04-1320.20..... 27	04-1396.11..... 30
01-1511.24..... 6	03-0112.24..... 17	04-1131.16..... 24	04-1320.23..... 27	04-1397.11..... 30
01-1513.20..... 6	03-0112.25..... 17	04-1131.18..... 24	04-1320.25..... 27	04-1400.11..... 30
01-1514.20..... 6	03-0112.26..... 17	04-1131.20..... 24	04-1320.28..... 27	04-1401.11..... 30
01-1515.17..... 6	03-0112.34..... 17	04-1132.14..... 43	04-1320.30..... 27	04-1404.11..... 47
01-1517.18..... 6	03-0112.36..... 17	04-1132.16..... 43	04-1321.14..... 27	04-1405.11..... 46
01-1610.01..... 7	03-0113.24..... 17	04-1133.14..... 43	04-1321.15..... 27	04-1406.11..... 31
01-1615.01..... 7	03-0113.36..... 17	04-1133.16..... 43	04-1321.18..... 27	04-1407.11..... 31
01-1620.19..... 7	03-0120.09..... 18	04-1140.10..... 24	04-1321.20..... 27	04-1408.18..... 31
01-1625.10..... 7	03-0121.09..... 18	04-1140.11..... 24	04-1321.23..... 27	04-1410.15..... 31
01-1625.20..... 7	03-0124.13..... 18	04-1140.13..... 24	04-1321.25..... 27	04-1415.16..... 31
01-1625.30..... 7	03-0220.01..... 19	04-1140.14..... 24	04-1321.28..... 27	04-1431.14..... 32
01-1625.50..... 7	03-0220.02..... 19	04-1140.15..... 24	04-1321.30..... 27	04-1435.17..... 31
01-1627.15..... 7	03-0220.03..... 19	04-1140.16..... 24	04-1324.11..... 46	04-1437.17..... 31
	03-0220.04..... 19	04-1140.18..... 24	04-1324.15..... 46	04-1445.18..... 32
	03-0220.05..... 19	04-1140.20..... 24	04-1324.18..... 46	04-1447.19..... 32
	03-0220.06..... 19	04-1141.10..... 24	04-1324.20..... 46	04-1449.17..... 32
	03-0220.07..... 19	04-1141.11..... 24	04-1324.23..... 46	04-1480.11..... 32
	03-0220.08..... 19	04-1141.13..... 24	04-1324.25..... 46	04-1483.21..... 33
	03-0220.09..... 19	04-1141.14..... 24	04-1324.28..... 46	04-1483.24..... 33
	03-0220.10..... 19	04-1141.15..... 24	04-1324.30..... 46	04-1483.25..... 33
	03-0224.01..... 20	04-1141.16..... 24	04-1325.11..... 46	04-1490.25..... 33
	03-0224.02..... 20	04-1142.14..... 43	04-1325.15..... 46	04-1490.40..... 33
	03-0306.05..... 21	04-1142.16..... 43	04-1325.18..... 46	04-1490-60..... 33
	03-0308.05..... 21	04-1143.14..... 43	04-1325.18..... 46	04-1494.25..... 48
	03-0318.13..... 20	04-1143.16..... 43	04-1325.20..... 46	04-1494.40..... 48
	03-0318.16..... 20	04-1143.16..... 43	04-1325.23..... 46	04-1494-60..... 48
	03-0318.19..... 20	04-1220.14..... 25	04-1325.25..... 46	04-1501.16..... 33
	03-0318.22..... 20	04-1224.14..... 25	04-1325.28..... 46	04-1501.23..... 33
	03-0318.28..... 20	04-1225.14..... 25	04-1325.30..... 46	04-1501.28..... 33
	03-0320.17..... 20	04-1234.14..... 44	04-1331.15..... 28	04-1502.16..... 33
	03-0320.20..... 20	04-1235.14..... 44	04-1331.18..... 28	04-1502.23..... 33
	03-0420.00..... 22	04-1242.14..... 25	04-1331.20..... 28	04-1502.28..... 33
	03-0420.01..... 22	04-1243.14..... 25	04-1331.23..... 28	04-1503.16..... 33
	03-0420.02..... 22	04-1252.14..... 44	04-1332.15..... 28	04-1503.23..... 33
	03-0510.25..... 21	04-1253.14..... 44	04-1332.18..... 28	04-1503.28..... 33
	03-0590.16..... 21	04-1256.14..... 25	04-1332.20..... 28	04-1505.15..... 32
	03-0590.20..... 21	04-1257.14..... 25	04-1332.23..... 28	04-1507.15..... 32
	03-0590.24..... 21	04-1260.14..... 26	04-1336.15..... 46	04-1521.22..... 34
		04-1260.17..... 26	04-1336.18..... 46	04-1523.22..... 34
		04-1260.23..... 26	04-1336.20..... 46	04-1525.22..... 48
	04	04-1261.14..... 26	04-1336.23..... 46	04-1527.22..... 48
	04-1120.10..... 24	04-1261.17..... 26	04-1336.25..... 46	04-1530.20..... 34
	04-1120.11..... 24	04-1261.23..... 26	04-1336.28..... 46	04-1530.23..... 34
	04-1120.13..... 24	04-1264.14..... 44	04-1337.15..... 46	04-1531.20..... 34
		04-1264.17..... 44	04-1337.18..... 46	04-1531.23..... 34

Nummernverzeichnis
Index of Numbers
Index des numéros de références
Indice de números de referencias

04-1534.23..... 48	05	06-1200.10..... 59	06-5867.11..... 64	07-0171.65..... 69
04-1535.23..... 48		06-1200.11..... 59	06-5902.07..... 64	07-0171.70..... 69
04-1543.24..... 34	05-1120.11..... 52	06-1200.13..... 59	06-5902.09..... 64	07-0171.75..... 69
04-1545.22..... 34	05-1122.11..... 52	06-1200.14..... 59	06-5902.11..... 64	07-0171.90..... 69
04-1550.17..... 34	05-1124.12..... 52	06-1200.16..... 59	06-5906.10..... 64	07-0520.10..... 70
04-1551-17..... 34	05-1125.11..... 52	06-1200.18..... 59	06-5907.10..... 64	07-0521.10..... 70
04-1556.27..... 35	05-1127.11..... 52	06-1200.20..... 59	06-5908.10..... 64	07-0522.10..... 70
04-1557.27..... 35	05-1129.11..... 52	06-1200.25..... 59	06-5909.10..... 64	07-0523.10..... 70
04-1560.16..... 36	05-1131.10..... 52	06-1200.30..... 59	06-5920.09..... 64	07-0600.12..... 70
04-1560.18..... 36	05-1133.10..... 52	06-1208.11..... 59	06-5920.11..... 64	07-0601.12..... 70
04-1561.16..... 36	05-1135.10..... 53	06-1208.13..... 59	06-5935.11..... 65	07-0602.12..... 70
04-1561.18..... 36	05-1137.10..... 53	06-1208.14..... 59	06-5932.13..... 65	07-0603.12..... 70
04-1570.10..... 35	05-1140.08..... 53	06-1208.16..... 59	06-5933.13..... 65	07-0620.12..... 71
04-1571.16..... 35	05-1141.08..... 53	06-1208.18..... 59	06-5934.14..... 65	07-0620.14..... 71
04-1573.15..... 35	05-1143.11..... 53	06-1208.20..... 59	06-5935.14..... 65	07-0620.18..... 71
04-1580.14..... 35	05-1145.11..... 53	06-1208.25..... 59	06-5938.15..... 65	07-0620.21..... 71
04-1580.22..... 35	05-1147.11..... 53	06-1223.13..... 59	06-7022.12..... 66	07-0621.12..... 71
04-1590.11..... 36	05-1152.18..... 54	06-1223.14..... 59	06-7022.15..... 66	07-0621.14..... 71
04-1591.11..... 36	05-1153.18..... 54	06-1223.16..... 59	06-7022.18..... 66	07-0621.18..... 71
04-1592.15..... 36	05-1156.18..... 54	06-1223.18..... 59	06-7023.12..... 66	07-0621.21..... 71
04-1593.15..... 36	05-1157.18..... 54	06-1223.20..... 59	06-7023.15..... 66	07-0622.12..... 71
04-1601.22..... 36		06-1223.25..... 59	06-7023.18..... 66	07-0622.14..... 71
04-1610.18..... 37	06	06-1234.13..... 59	06-8014.16..... 66	07-0622.18..... 71
04-1611.18..... 37		06-1234.14..... 59	06-8014.20..... 66	07-0622.21..... 71
04-1614.19..... 37	06-0200.10..... 56	06-1234.16..... 59	06-8014.24..... 66	07-0623.12..... 71
04-1617.17..... 37	06-0200.11..... 56	06-1245.13..... 59	06-8014.30..... 66	07-0623.14..... 71
04-1619.17..... 37	06-0200.13..... 56	06-1245.14..... 59	06-8016.16..... 66	07-0623.18..... 71
04-1621.30..... 38	06-0200.14..... 56	06-1245.16..... 59	06-8016.20..... 66	07-0623.21..... 71
04-1623.18..... 37	06-0200.16..... 56	06-1312.12..... 59	06-8016.24..... 66	07-0650.19..... 83
04-1623.25..... 37	06-0200.18..... 56	06-1312.13..... 59	06-8028.16..... 66	07-0651.19..... 83
04-1631.24..... 38	06-0200.20..... 56	06-1312.14..... 59	06-8028.20..... 66	07-0652.19..... 83
04-1641.23..... 38	06-0200.25..... 56	06-1312.15..... 59	06-8028.24..... 66	07-0653.19..... 83
04-1650.21..... 39	06-0200.30..... 56	06-1312.18..... 59	06-8028.30..... 66	07-0655.18..... 83
04-1652.21..... 39	06-0208.11..... 56	06-1312.21..... 59	06-8029.16..... 66	07-0671.14..... 79
04-1654.21..... 39	06-0208.13..... 56	06-1312.25..... 59	06-8029.20..... 66	07-0710.15..... 82
04-1660.09..... 39	06-0208.14..... 56	06-1320.15..... 60	06-8029.24..... 66	07-0711.15..... 82
04-1662.11..... 39	06-0208.16..... 56	06-1332.14..... 60	06-8029.30..... 66	07-0712.15..... 82
04-1663.13..... 39	06-0208.18..... 56	06-1334.14..... 60	06-8030.16..... 66	07-0713.15..... 82
04-1664.14..... 39	06-0208.20..... 56	06-1342.18..... 60	06-8030.20..... 66	07-0726.14..... 73
04-1669.15..... 39	06-0208.25..... 56	06-1344.18..... 60	06-8030.24..... 66	07-0727.14..... 73
04-1670.13..... 40	06-0208.30..... 56	06-1350.12..... 60	06-8030.30..... 66	07-0730.20..... 83
04-1671.13..... 40	06-0212.14..... 58	06-1350.15..... 60	06-8032.16..... 66	07-0731.20..... 83
04-1674.12..... 40	06-0212.16..... 58	06-1351.12..... 60	06-8032.20..... 66	07-0733.20..... 83
04-1675.12..... 40	06-0312.12..... 56	06-1351.15..... 60		07-0751.24..... 88
04-1677.12..... 40	06-0312.13..... 56	06-1366.15..... 60	07	07-0774.20..... 82
04-1731.12..... 41	06-0312.14..... 56	06-1370.18..... 61	07-0070.07..... 68	07-0774.26..... 82
04-1735.12..... 49	06-0312.15..... 56	06-1371.18..... 61	07-0070.08..... 68	07-0775.20..... 82
04-1740.10..... 41	06-0312.18..... 56	06-1373.18..... 61	07-0070.10..... 68	07-0775.26..... 82
04-1741.10..... 41	06-0312.21..... 56	06-1380.12..... 61	07-0070.12..... 68	07-0776.20..... 82
04-1742.10..... 41	06-0312.25..... 56	06-1380.15..... 61	07-0071.02..... 68	07-0776.26..... 82
04-1743.10..... 41	06-0320.15..... 56	06-1386.12..... 61	07-0071.07..... 68	07-0777.20..... 82
04-1748.15..... 41	06-0320.17..... 56	06-1390.17..... 61	07-0071.08..... 68	07-0777.26..... 82
04-1748.16..... 41	06-0350.12..... 56	06-1420.18..... 61	07-0071.10..... 68	07-0800.14..... 72
04-1748.18..... 41	06-0350.15..... 56	06-1420.21..... 61	07-0071.12..... 68	07-0801.14..... 72
04-1748.20..... 41	06-0351.12..... 56	06-1420.25..... 61	07-0150.06..... 68	07-0802.14..... 72
04-1751.11..... 41	06-0351.15..... 56	06-5020.10..... 62	07-0150.07..... 68	07-0803.14..... 72
04-1751.14..... 41	06-0360.15..... 56	06-5110.15..... 62	07-0150.09..... 68	07-0820.14..... 72
04-1751.18..... 41	06-0370.18..... 57	06-5110.20..... 62	07-0150.11..... 68	07-0821.14..... 72
04-1751.20..... 41	06-0371.18..... 57	06-5146.15..... 62	07-0151.06..... 68	07-0822.14..... 72
04-1755.18..... 49	06-0373.18..... 57	06-5210.15..... 62	07-0151.07..... 68	07-0823.14..... 72
04-1761.23..... 41	06-0380.12..... 57	06-5210.20..... 62	07-0151.09..... 68	07-0826.16..... 73
04-1763.20..... 42	06-0380.15..... 57	06-5210.25..... 62	07-0151.11..... 68	07-0827.20..... 73
04-1763.22..... 42	06-0384.12..... 58	06-5260.23..... 63	07-0160.04..... 69	07-0828.16..... 73
04-1770.14..... 42	06-0384.15..... 58	06-5270.23..... 63	07-0160.05..... 69	07-0829.16..... 73
04-1773.23..... 42	06-0386.12..... 57	06-5314.07..... 62	07-0161.04..... 69	07-0840.15..... 91
04-1775.23..... 42	06-0386.15..... 57	06-5320.20..... 62	07-0161.05..... 69	07-0841.15..... 91
04-1777.23..... 42	06-0390.17..... 57	06-5330.23..... 63	07-0170.50..... 69	07-0860.16..... 78
04-1779.23..... 49	06-0420.18..... 57	06-5340.12..... 62	07-0170.55..... 69	07-0861.20..... 78
04-1780.20..... 42	06-0420.21..... 57	06-5344.16..... 62	07-0170.65..... 69	07-0860.20..... 78
04-1782.15..... 42	06-0420.25..... 57	06-5344.20..... 62	07-0170.70..... 69	07-0861.18..... 78
04-1782.18..... 42	06-0420.30..... 57	06-5344.25..... 62	07-0170.75..... 69	07-0920.14..... 80
	06-0424.18..... 58	06-5862.11..... 64	07-0170.90..... 69	07-0930.14..... 73
	06-0424.21..... 58	06-5864.11..... 64	07-0171.50..... 69	07-0931.14..... 73
	06-0424.25..... 58	06-5866.11..... 64	07-0171.55..... 69	07-0940.13..... 74

Nummernverzeichnis
Index of Numbers
Index des numéros de références
Indice de números de referencias

07-0940.14..... 74	07-1701.04..... 86	07-9902.18..... 96	09-0586.03..... 112	09-1271.55..... 118
07-0940.16..... 74	07-1711.01..... 84	07-9902.20..... 96	09-0586.04..... 112	09-1273.19..... 118
07-0940.18..... 74	07-1711.02..... 84	07-9906.14..... 96	09-0586.12..... 112	09-1273.21..... 118
07-0940.20..... 74	07-1711.03..... 84	07-9912.16..... 96	09-0586.13..... 112	09-1275.10..... 119
07-0940.22..... 74	07-1711.04..... 84		09-0586.14..... 112	09-1275.15..... 119
07-0940.24..... 74	07-1711.05..... 84	08	09-0591.02..... 115	09-1275.20..... 119
07-0940.26..... 74	07-1711.06..... 84		09-0591.03..... 115	09-2010.14..... 119
07-0940.28..... 75	07-1711.07..... 84	08-9013.09..... 98	09-0591.04..... 115	09-2010.20..... 119
07-0940.30..... 74	07-1713.01..... 84	08-9015.09..... 98	09-0591.06..... 115	09-2010.26..... 119
07-0941.13..... 75	07-1713.02..... 84	08-9021.09..... 98	09-0591.12..... 115	09-2050.22..... 119
07-0941.14..... 75	07-1713.03..... 84	08-9043.18..... 99	09-0591.13..... 115	09-2061.50..... 126
07-0941.16..... 75	07-1713.04..... 84	08-9050.20..... 99	09-0591.14..... 115	09-2061.90..... 126
07-0941.18..... 75	07-1713.05..... 84	08-9065.09..... 98	09-0591.16..... 115	09-2074.28..... 107
07-0941.20..... 75	07-1713.06..... 84	08-9065.11..... 98	09-0610.16..... 108	09-2074.36..... 107
07-0941.22..... 75	07-1713.07..... 84	08-9065.13..... 98	09-0611.16..... 108	09-2074.44..... 107
07-0941.24..... 75	07-1743.13..... 85	08-9065.15..... 98	09-0836.16..... 114	09-2074.52..... 107
07-0941.26..... 75	07-1743.16..... 85	08-9067.11..... 98	09-0836.26..... 114	09-2075.00..... 107
07-0941.28..... 75	07-1743.18..... 85	08-9069.13..... 98	09-0850.20..... 113	09-2076.65..... 107
07-0941.30..... 75	07-1743.20..... 85	08-9101.16..... 99	09-0850.21..... 113	09-2078.38..... 107
07-1028.14..... 78	07-1743.23..... 85	08-9103.19..... 99	09-0856.12..... 113	09-2232.25..... 109
07-1029.14..... 78	07-1743.25..... 85	08-9111.11..... 99	09-0856.14..... 113	09-2232.40..... 109
07-1030.13..... 76	07-1743.28..... 85	08-9111.13..... 99	09-0856.16..... 113	09-2232.62..... 109
07-1030.14..... 76	07-1745.18..... 85	08-9121.13..... 99	09-0856.18..... 113	09-2240.01..... 110
07-1030.16..... 76	07-1745.22..... 85	08-9306.13..... 102	09-0940.08..... 113	09-2240.02..... 110
07-1030.18..... 76	07-1745.25..... 85	08-9346.25..... 102	09-0940.10..... 113	09-2240.03..... 110
07-1030.20..... 76	07-1745.28..... 85	08-9380.20..... 100	09-0940.12..... 113	09-2240.04..... 110
07-1030.22..... 76	07-4524.16..... 79	08-9380.25..... 100	09-0940.14..... 113	09-2240.05..... 110
07-1030.24..... 76	07-4525.16..... 79	08-9381.20..... 100	09-0940.16..... 113	09-2240.06..... 110
07-1030.26..... 76	07-4377.15..... 80	08-9381.25..... 100	09-0940.18..... 113	09-2240.07..... 110
07-1030.28..... 76	07-4372.15..... 80	08-9500.25..... 102	09-1061.01..... 115	09-2240.08..... 110
07-1030.30..... 76	07-4504.15..... 80	08-9503.25..... 102	09-1061.02..... 115	09-2240.09..... 110
07-1031.13..... 77	07-4501.14..... 80	08-9510.22..... 100	09-1061.03..... 115	09-2241.25..... 109
07-1031.14..... 77	07-4501.19..... 80	08-9510.25..... 100	09-1061.04..... 115	09-2241.38..... 109
07-1031.16..... 77	07-4310.13..... 81	08-9511.22..... 100	09-1061.06..... 115	09-2241.50..... 109
07-1031.18..... 77	07-4312.13..... 81	08-9511.25..... 100	09-1061.11..... 115	09-2252.22..... 125
07-1031.20..... 77	07-4350.14..... 81	08-9520.18..... 101	09-1061.12..... 115	09-2252.38..... 125
07-1031.22..... 77	07-4372.15..... 80	08-9520.25..... 101	09-1061.13..... 115	09-2252.45..... 125
07-1031.24..... 77	07-4377.15..... 80	08-9521.18..... 101	09-1061.14..... 115	09-2252.65..... 125
07-1031.26..... 77	07-4501.14..... 80	08-9521.25..... 101	09-1061.16..... 115	09-2255.25..... 125
07-1031.28..... 77	07-4501.19..... 80	08-9522.18..... 101	09-1071.01..... 114	09-2255.45..... 125
07-1031.30..... 77	07-4504.15..... 80	08-9522.20..... 101	09-1071.02..... 114	09-2255.60..... 125
07-1050.14..... 78	07-4524.16..... 79	08-9522.25..... 101	09-1071.03..... 114	09-2255.75..... 125
07-1051.14..... 78	07-4525.16..... 79	08-9523.18..... 101	09-1071.04..... 114	09-2268.22..... 124
07-1059.01..... 88	07-4542.16..... 81	08-9523.20..... 101	09-1071.05..... 114	09-2268.27..... 124
07-1059.02..... 88	07-4601.23..... 92	08-9523.25..... 101	09-1071.06..... 114	09-2269.45..... 124
07-1066.24..... 87	07-4621.23..... 94	08-9544.25..... 101	09-1124.08..... 121	09-2269.73..... 124
07-1067.24..... 87	07-4613.25..... 95	08-9545.25..... 101	09-1124.18..... 121	09-2269.82..... 124
07-1070.22..... 87	07-4623.20..... 93	08-9546.25..... 101	09-1145.08..... 120	09-2324.40..... 121
07-1071.22..... 87	07-4623.22..... 93	08-9547.13..... 102	09-1155.40..... 120	09-2324.50..... 121
07-1080.21..... 86	07-4623.24..... 93	08-9570.26..... 103	09-1155.50..... 120	09-2324.60..... 121
07-1081.21..... 86	07-4626.23..... 93	08-9579.26..... 103	09-1155.60..... 120	09-2324.70..... 121
07-1082.21..... 86	07-4627.23..... 92		09-1155.70..... 120	09-2335.85..... 122
07-1083.21..... 86	07-4825.18..... 91	09	09-1172.01..... 116	09-2342.25..... 122
07-1109.28..... 89	07-4837.21..... 92		09-1172.02..... 116	09-2345.45..... 122
07-1115.28..... 89	07-4841.21..... 92	09-0136.13..... 111	09-1172.03..... 116	09-2345.55..... 122
07-1521.14..... 90	07-4853.22..... 93	09-0136.18..... 111	09-1172.04..... 116	09-2345.65..... 122
07-1521.18..... 90	07-4853.23..... 93	09-0350.12..... 111	09-1172.05..... 116	09-2361.35..... 123
07-1523.15..... 90	07-4855.22..... 93	09-0351.12..... 111	09-1181.01..... 116	09-2361.38..... 123
07-1523.19..... 90	07-4855.23..... 93	09-0362.01..... 111	09-1181.02..... 116	09-2361.50..... 123
07-1539.26..... 92	07-4865.23..... 92	09-0362.02..... 111	09-1181.03..... 116	09-2361.57..... 123
07-1551.19..... 91	07-6100.21..... 94	09-0516.01..... 111	09-1181.04..... 116	09-2371.63..... 124
07-1551.23..... 91	07-6101.21..... 94	09-0516.02..... 111	09-1181.05..... 116	09-2371.65..... 124
07-1559.20..... 91	07-6127.21..... 94	09-0516.05..... 111	09-1191.60..... 117	09-2395.16..... 108
07-1563.22..... 90	07-6135.23..... 94	09-0516.07..... 111	09-1221.85..... 117	09-2500.19..... 108
07-1563.25..... 90	07-6135.23..... 94	09-0516.10..... 111	09-1239.28..... 114	09-2516.00..... 106
07-1563.28..... 90	07-6223.20..... 95	09-0556.01..... 112	09-1242.12..... 114	09-2516.13..... 108
07-1573.22..... 89	07-6243.20..... 95	09-0556.02..... 112	09-1253.40..... 118	09-2516.25..... 108
07-1583.14..... 90	07-6245.20..... 95	09-0556.03..... 112	09-1253.57..... 118	09-2517.11..... 108
07-1583.16..... 90	07-6321.20..... 95	09-0556.04..... 112	09-1253.78..... 118	09-2543.00..... 106
07-1583.18..... 90	07-6323.20..... 95	09-0556.11..... 112	09-1261.07..... 117	09-2545.00..... 106
07-1583.23..... 90	07-9900.15..... 96	09-0556.12..... 112	09-1261.10..... 117	09-2563.00..... 106
07-1701.01..... 86	07-9900.18..... 96	09-0556.13..... 112	09-1261.15..... 117	09-2568.00..... 106
07-1701.02..... 86	07-9900.20..... 96	09-0556.14..... 112	09-1261.20..... 117	09-2589.00..... 106
07-1701.03..... 86	07-9902.15..... 96	09-0586.02..... 112	09-1271.40..... 118	09-2591.00..... 106

Nummernverzeichnis
Index of Numbers
Index des numéros de références
Indice de números de referencias

09-2751.28..... 109	09-6320.65..... 137	10-0828.18..... 143	11-5230.12..... 149	12-2538.16..... 157
09-2763.25..... 109	09-6324.10..... 137	10-1150.45..... 143	11-5232.07..... 149	12-2540.16..... 164
09-2763.32..... 109	09-6324.98..... 137	10-5650.00..... 141	11-5232.10..... 149	12-2541.14..... 158
09-2763.40..... 109	09-6330.10..... 137	10-5650.03..... 141	11-5232.12..... 149	12-2544.14..... 158
09-2763.50..... 109	09-6810.10..... 135	10-5650.06..... 141	11-5240.05..... 149	12-2546.10..... 158
09-2766.18..... 109	09-6812.85..... 135	10-5650.09..... 141	11-5240.10..... 149	12-2547.10..... 158
09-2766.30..... 109	09-6830.09..... 133	10-5650.12..... 141	11-5270.14..... 149	12-2549.13..... 164
09-2766.37..... 109	09-6830.14..... 133	10-5650.15..... 141	11-5270.20..... 149	12-2551.13..... 164
09-2780.12..... 109	09-6830.16..... 133	10-5650.90..... 141		12-2552.14..... 158
09-2780.17..... 109	09-6830.18..... 133	10-5650.80..... 141	12	12-2553.14..... 158
09-2780.25..... 109	09-6831.18..... 133	10-5650.02..... 141	12-2458.23..... 153	12-2555.14..... 164
09-5107.04..... 127	09-6832.18..... 133	10-5681.04..... 142	12-2460.23..... 161	12-2556.13..... 158
09-5107.14..... 127	09-7915.03..... 138	10-5681.06..... 142	12-2461.21..... 154	12-2557.14..... 164
09-5110.04..... 127	09-7924.10..... 138	10-5681.07..... 142	12-2463.21..... 161	12-2558.13..... 164
09-5110.14..... 127		10-5681.08..... 142	12-2466.27..... 154	12-5024.12..... 152
09-5130.04..... 127	10	10-5681.10..... 142	12-2466.27..... 154	12-5026.12..... 159
09-5130.14..... 127	10-0010.11..... 140	10-5681.12..... 142	12-2468.27..... 162	12-5028.13..... 152
09-5134.34..... 127	10-0010.13..... 140	10-5681.14..... 142	12-2470.27..... 154	12-5030.13..... 152
09-5134.44..... 127	10-0010.14..... 140	10-5682.12..... 142	12-2472.27..... 162	12-5032.13..... 152
09-5211.23..... 127	10-0010.14..... 140		12-2474.27..... 154	12-5034.13..... 152
09-5211.43..... 127	10-0010.16..... 140	11	12-2476.27..... 162	12-5036.13..... 159
09-5213.34..... 128	10-0010.18..... 140	11-2131.30..... 148	12-2477.20..... 161	12-5038.13..... 159
09-5213.44..... 128	10-0010.20..... 140	11-2131.40..... 148	12-2477.24..... 161	12-5040.13..... 152
09-5214.34..... 128	10-0010.25..... 140	11-2131.50..... 148	12-2477.26..... 161	12-5042.13..... 153
09-5214.44..... 128	10-0052.11..... 140	11-2131.50..... 148	12-2478.18..... 154	12-5042.14..... 153
09-5216.34..... 128	10-0052.13..... 140	11-2135.30..... 147	12-2480.18..... 154	12-5046.13..... 159
09-5216.44..... 128	10-0052.14..... 140	11-3004.00..... 146	12-2480.18..... 154	12-5048.14..... 159
09-5220.34..... 128	10-0052.16..... 140	11-3010.30..... 146	12-2481.27..... 155	12-5220.14..... 153
09-5220.44..... 128	10-0052.18..... 140	11-3010.35..... 146	12-2485.20..... 155	12-5220.16..... 153
09-5312.03..... 127	10-0052.20..... 140	11-3010.40..... 146	12-2485.27..... 155	12-5220.18..... 153
09-5312.13..... 127	10-0052.25..... 140	11-3010.45..... 146	12-2487.20..... 162	12-5220.20..... 153
09-5363.11..... 128	10-0053.11..... 140	11-3010.50..... 146	12-2487.27..... 162	12-5220.24..... 153
09-5364.11..... 128	10-0053.13..... 140	11-3010.55..... 146	12-2488.18..... 155	12-5220.26..... 153
09-5445.44..... 131	10-0053.14..... 140	11-3010.60..... 146	12-2488.26..... 155	12-5220.30..... 153
09-5620.44..... 129	10-0053.16..... 140	11-3012.30..... 146	12-2490.18..... 161	12-5220.30..... 153
09-5620.84..... 129	10-0053.18..... 140	11-3012.35..... 146	12-2490.26..... 161	12-5222.14..... 160
09-5626.44..... 129	10-0053.20..... 140	11-3012.40..... 146	12-2490.26..... 161	12-5222.16..... 160
09-5626.84..... 129	10-0053.25..... 140	11-3012.45..... 146	12-2492.23..... 155	12-5222.18..... 160
09-5681.44..... 130	10-0065.14..... 140	11-3012.50..... 146	12-2494.23..... 161	12-5222.20..... 160
09-5693.45..... 129	10-0065.16..... 140	11-3012.55..... 146	12-2496.15..... 156	12-5222.24..... 160
09-5702.77..... 130	10-0065.16..... 140	11-3012.60..... 146	12-2498.18..... 156	12-5222.26..... 160
09-5854.18..... 131	10-0082.10..... 141	11-3012.60..... 146	12-2500.18..... 164	12-5222.30..... 160
09-5855.18..... 131	10-0100.11..... 140	11-3020.25..... 147	12-2503.25..... 155	12-5222.30..... 160
09-5910.00..... 132	10-0100.11..... 140	11-3020.30..... 147	12-2504.14..... 156	12-5224.16..... 153
09-5910.01..... 132	10-0100.13..... 140	11-3020.33..... 147	12-2504.17..... 156	12-5224.18..... 153
09-5910.04..... 132	10-0100.14..... 140	11-3020.35..... 147	12-2504.20..... 156	12-5224.20..... 153
09-5910.45..... 132	10-0100.16..... 140	11-3020.35..... 147	12-2504.24..... 156	12-5228.16..... 160
09-5910.50..... 132	10-0100.18..... 140	11-3034.10..... 148	12-2506.14..... 163	12-5228.18..... 160
09-5910.55..... 132	10-0100.20..... 140	11-3034.12..... 148	12-2506.17..... 163	12-5228.20..... 160
09-5910.60..... 132	10-0101.14..... 141	11-3034.14..... 148	12-2506.20..... 163	12-5302.15..... 153
09-5910.95..... 132	10-0110.13..... 140	11-3034.16..... 148	12-2506.24..... 163	12-5302.18..... 153
09-5912.00..... 132	10-0110.14..... 140	11-3034.18..... 148	12-2508.17..... 156	12-5302.20..... 153
09-5912.01..... 132	10-0110.16..... 140	11-3034.20..... 148	12-2508.20..... 156	12-5312.15..... 159
09-5912.40..... 132	10-0110.18..... 140	11-3034.22..... 148	12-2510.17..... 163	12-5312.18..... 159
09-5912.45..... 132	10-0502.13..... 141	11-3034.24..... 148	12-2510.20..... 163	12-5312.20..... 159
09-5912.50..... 132	10-0502.14..... 141	11-3034.26..... 148	12-2512.14..... 156	12-5320.15..... 153
09-5912.55..... 132	10-0642.15..... 143	11-3034.28..... 148	12-2512.17..... 156	12-5322.15..... 159
09-5912.60..... 132	10-0712.12..... 143	11-3040.00..... 147	12-2514.14..... 163	12-5450.15..... 160
09-5912.95..... 132	10-0712.14..... 143	11-3115.30..... 147	12-2514.17..... 163	12-5450.18..... 160
09-6040.10..... 134	10-0712.16..... 143	11-3154.18..... 147	12-2516.14..... 156	12-5450.20..... 160
09-6041.60..... 134	10-0712.18..... 143	11-3810.35..... 148	12-2516.18..... 156	12-5450.23..... 160
09-6041.80..... 134	10-0712.23..... 143	11-3810.70..... 148	12-2518.14..... 163	12-5450.26..... 160
09-6050.10..... 134	10-0732.12..... 143	11-3812.70..... 148	12-2518.18..... 163	12-5450.28..... 160
09-6214.16..... 135	10-0732.14..... 143	11-3812.99..... 148	12-2520.17..... 157	12-5450.30..... 160
09-6215.14..... 135	10-0732.16..... 143	11-3814.70..... 148	12-2522.17..... 163	12-5456.13..... 161
09-6230.45..... 136	10-0732.18..... 143	11-3814.99..... 148	12-2524.16..... 157	12-5456.15..... 161
09-6230.70..... 136	10-0732.23..... 143	11-3816.70..... 148	12-2528.16..... 163	12-5456.18..... 161
09-6230.80..... 136	10-0815.12..... 143	11-3818.99..... 148	12-2530.16..... 164	12-5456.20..... 161
09-6232.09..... 136	10-0815.14..... 143	11-3830.14..... 148	12-2530.18..... 164	12-5456.23..... 161
09-6240.18..... 136	10-0815.16..... 143	11-3830.18..... 148	12-2530.20..... 164	
09-6244.20..... 136	10-0815.18..... 143	11-3830.64..... 148	12-2530.23..... 164	13
09-6244.25..... 136	10-0816.12..... 143	11-3830.68..... 148	12-2530.26..... 164	13-0714.13..... 167
09-6320.10..... 137	10-0816.14..... 143	11-3851.00..... 148	12-2532.11..... 157	13-0715.13..... 167
09-6320.55..... 137	10-0816.16..... 143	11-5220.00..... 149	12-2534.13..... 157	13-0717.24..... 167
	10-0816.18..... 143	11-5230.07..... 149	12-2534.15..... 157	13-0718.24..... 167
	10-0828.12..... 143	11-5230.10..... 149	12-2536.12..... 157	

Nummernverzeichnis
Index of Numbers
Index des numéros de références
Indice de números de referencias

13-0721.21..... 166	13-9510.12..... 176	15-0230.25..... 211	15-1074.02..... 204	15-1200.15..... 206
13-0721.24..... 166	13-9510.14..... 176	15-0230.40..... 211	15-1074.03..... 204	15-1210.06..... 206
13-0721.27..... 166	13-9510.16..... 176	15-0231.75..... 211	15-1074.04..... 204	15-1210.15..... 206
13-0723.21..... 166	13-9510.18..... 176	15-0300.27..... 191	15-1074.05..... 204	15-1210.20..... 206
13-0723.24..... 166	13-9510.20..... 176	15-0301.27..... 191	15-1074.06..... 204	15-1210.25..... 206
13-0723.27..... 166	13-9510.22..... 176	15-0305.27..... 191	15-1074.07..... 204	15-1210.30..... 206
13-0725.21..... 166	13-9060.12..... 175	15-0307.23..... 190	15-1074.08..... 204	15-1210.38..... 206
13-0725.24..... 166	13-9061.13..... 175	15-0531.12..... 184	15-1090.26..... 188	15-1210.44..... 206
13-0725.27..... 166	13-9067.13..... 175	15-0533.14..... 184	15-1091.22..... 188	15-1211.06..... 206
13-0727.21..... 166	13-9069.14..... 175	15-0535.90..... 184	15-1091.26..... 188	15-1211.15..... 206
13-0727.24..... 166	13-9500.00..... 176	15-0540.15..... 184	15-1095.23..... 188	15-1211.20..... 206
13-0727.27..... 166	13-9514.60..... 176	15-0544.14..... 184	15-1112.04..... 203	15-1211.25..... 206
13-0765.19..... 167	13-9952.20..... 177	15-0544.17..... 184	15-1112.06..... 203	15-1211.30..... 206
13-1015.01..... 168	13-9952.30..... 177	15-0561.17..... 184	15-1112.08..... 203	15-1211.38..... 206
13-1015.02..... 168	13-9954.23..... 177	15-0563.16..... 184	15-1112.10..... 203	15-1211.44..... 206
13-1015.03..... 168	13-9955.27..... 177	15-0576.30..... 185	15-1112.12..... 203	15-1230.06..... 207
13-1015.04..... 168	13-9956.20..... 177	15-0576.45..... 185	15-1112.14..... 203	15-1230.09..... 207
13-1019.01..... 168	13-9956.28..... 177	15-0576.90..... 185	15-1114.04..... 203	15-1230.10..... 207
13-1019.02..... 168	13-9957.20..... 177	15-0636.16..... 186	15-1114.06..... 203	15-1230.13..... 207
13-1019.03..... 168	13-9957.28..... 177	15-0637.16..... 186	15-1114.08..... 203	15-1230.16..... 207
13-1019.04..... 168	13-9960.12..... 177	15-0638.18..... 186	15-1114.10..... 203	15-1230.19..... 207
13-1021.01..... 168	13-9962.14..... 177	15-0639.18..... 186	15-1114.12..... 203	15-1230.25..... 207
13-1021.02..... 168		15-0650.17..... 185	15-1114.14..... 203	15-1230.32..... 207
13-1021.03..... 168	14	15-0651.17..... 185	15-1128.05..... 189	15-1231.06..... 207
13-1021.04..... 168		15-0655.01..... 185	15-1128.08..... 189	15-1231.09..... 207
13-1023.01..... 168	14-0600.23..... 180	15-0655.02..... 185	15-1130.10..... 205	15-1231.10..... 207
13-1023.02..... 168	14-0600.26..... 180	15-0670.20..... 186	15-1130.15..... 205	15-1231.13..... 207
13-1023.03..... 168	14-0600.37..... 180	15-0671.20..... 186	15-1130.20..... 205	15-1231.16..... 207
13-1023.04..... 168	14-0620.24..... 180	15-0677.20..... 185	15-1130.25..... 205	15-1231.19..... 207
13-1027.00..... 167	14-0622.19..... 180	15-1000.15..... 187	15-1132.10..... 205	15-1231.25..... 207
13-1027.01..... 167	14-0710.14..... 180	15-1001.15..... 187	15-1132.15..... 205	15-1231.32..... 207
13-1027.02..... 167	14-0712.18..... 180	15-1011.18..... 186	15-1132.20..... 205	15-1234.06..... 207
13-1027.03..... 167	14-0810.11..... 182	15-1013.18..... 186	15-1132.25..... 205	15-1234.09..... 207
13-2068.19..... 169	14-0810.22..... 182	15-1020.08..... 203	15-1133.31..... 187	15-1234.10..... 207
13-2069.19..... 169	14-0810.50..... 182	15-1020.10..... 203	15-1134.10..... 205	15-1234.13..... 207
13-2030.01..... 169	14-0810.65..... 182	15-1020.12..... 203	15-1134.15..... 205	15-1234.16..... 207
13-2035.25..... 169	14-0811.50..... 182	15-1020.14..... 203	15-1134.20..... 205	15-1234.19..... 207
13-2089.20..... 169	14-0811.65..... 182	15-1020.16..... 203	15-1134.25..... 205	15-1234.25..... 207
13-2110.22..... 169	14-0812.13..... 182	15-1022.08..... 203	15-1135.24..... 188	15-1234.32..... 207
13-2111.22..... 169	14-0920.28..... 181	15-1022.10..... 203	15-1150.04..... 205	15-1250.06..... 207
13-2125.18..... 169	14-0922.30..... 181	15-1022.12..... 203	15-1150.06..... 205	15-1250.13..... 207
13-2125.27..... 169	14-0924.28..... 181	15-1022.14..... 203	15-1150.08..... 205	15-1250.19..... 207
13-5711.18..... 175	14-0930.23..... 181	15-1022.16..... 203	15-1150.10..... 205	15-1250.25..... 207
13-5720.12..... 175	14-0932.20..... 181	15-1024.08..... 203	15-1150.12..... 205	15-1250.32..... 207
13-5730.12..... 175	14-0934.18..... 181	15-1024.10..... 203	15-1154.04..... 205	15-1251.06..... 207
13-5732.12..... 175	14-0936.18..... 181	15-1024.12..... 203	15-1154.06..... 205	15-1251.13..... 207
13-5734.12..... 175	14-0953.18..... 181	15-1024.14..... 203	15-1154.08..... 205	15-1251.19..... 207
13-5821.16..... 177	14-0953.24..... 181	15-1024.16..... 203	15-1154.10..... 205	15-1251.25..... 207
13-5821.20..... 177		15-1050.18..... 187	15-1154.12..... 205	15-1251.32..... 207
13-5821.24..... 177		15-1051.18..... 187	15-1156.03..... 205	15-1252.06..... 208
13-8010.01 -	15	15-1055.23..... 186	15-1156.05..... 205	15-1252.13..... 208
13-8010.16..... 170	15-0093.23..... 211	15-1061.23..... 187	15-1156.06..... 205	15-1252.19..... 208
13-8011.01 -	15-0100.45..... 210	15-1062.02..... 204	15-1156.08..... 205	15-1252.25..... 208
13-8011.16..... 170	15-0100.90..... 210	15-1062.03..... 204	15-1156.09..... 205	15-1252.32..... 208
13-8012.01 -	15-0110.19..... 190	15-1062.04..... 204	15-1160.07..... 206	15-1254.06..... 208
13-8012.16..... 171	15-0120.20..... 210	15-1062.05..... 204	15-1160.10..... 206	15-1254.13..... 208
13-8013.01 -	15-0144.34..... 210	15-1062.06..... 204	15-1160.15..... 206	15-1254.19..... 208
13.8013.09..... 171	15-0145.26..... 210	15-1062.07..... 204	15-1160.20..... 206	15-1254.25..... 208
13-8015.01 -	15-0150.14..... 190	15-1062.08..... 204	15-1160.25..... 206	15-1254.32..... 208
13-8015.12..... 170	15-0150.17..... 190	15-1064.02..... 204	15-1160.30..... 206	15-1255.06..... 208
13-8016.30 -	15-0150.19..... 190	15-1064.03..... 204	15-1162.21..... 189	15-1255.13..... 208
13-8016.05..... 172	15-0150.22..... 190	15-1064.04..... 204	15-1163.21..... 189	15-1255.19..... 208
13-8018.01 -	15-0151.14..... 190	15-1064.05..... 204	15-1164.07..... 206	15-1255.25..... 208
13-8017.06..... 173	15-0151.17..... 190	15-1064.06..... 204	15-1164.10..... 206	15-1255.32..... 208
13-8020.01 -	15-0151.19..... 190	15-1064.07..... 204	15-1164.15..... 206	15-1613.22..... 209
13-8018.06..... 173	15-0151.22..... 190	15-1064.08..... 204	15-1164.20..... 206	15-1620.16..... 209
13-8021.05 -	15-0200.15..... 190	15-1065.23..... 187	15-1164.25..... 206	15-1625.60..... 220
13-8021.20..... 173	15-0201.15..... 190	15-1072.02..... 204	15-1164.30..... 206	15-1628.01..... 209
13-8022.05 -	15-0210.19..... 190	15-1072.03..... 204	15-1200.03..... 206	15-1628.02..... 209
13-8022.20..... 174	15-0211.19..... 190	15-1072.04..... 204	15-1200.04..... 206	15-1630.00..... 209
13-8023.05 -	15-0219.25..... 210	15-1072.05..... 204	15-1200.06..... 206	15-1630.26..... 219
13-8023.20..... 174	15-0221.68..... 210	15-1072.06..... 204	15-1200.08..... 206	15-1631.26..... 219
13-9510.07..... 176	15-0228.32..... 211	15-1072.07..... 204	15-1200.10..... 206	15-1633.17..... 220
13-9510.11..... 176	15-0228.92..... 211	15-1072.08..... 204	15-1200.12..... 206	15-1635.16..... 220

Nummernverzeichnis
Index of Numbers
Index des numéros de références
Indice de números de referencias

19-1245.12..... 288	19-1482.20..... 296	19-7010.01..... 300	19-7609.03..... 312	20-4191.01..... 322
19-1251.12..... 288	19-1485.13..... 296	19-7011.01..... 300	19-7620.09..... 312	20-4191.03..... 322
19-1253.12..... 289	19-1487.14..... 296	19-7011.02..... 300	19-7622.09..... 312	20-4191.04..... 322
19-1256.12..... 289	19-1501.06..... 296	19-7012.01..... 300	19-7636.09..... 312	20-4191.15..... 322
19-1258.12..... 289	19-1501.10..... 296	19-7013.01..... 300	19-7702.09..... 307	20-4191.17..... 322
19-1262.12..... 289	19-1501.12..... 296	19-7013.02..... 300	19-7703.09..... 307	20-4191.22..... 322
19-1271.11..... 289	19-1511.13..... 297	19-7020.07..... 300	19-7704.09..... 307	20-4596.50..... 322
19-1273.13..... 290	19-1513.14..... 297	19-7021.07..... 300	19-7705.09..... 307	20-4596.75..... 322
19-1304.12..... 290	19-1515.14..... 297	19-7022.07..... 300	19-7710.11..... 307	20-4597.10..... 322
19-1305.12..... 290	19-1517.09..... 297	19-7023.07..... 300	19-7720.09..... 307	20-4597.15..... 322
19-1310.13..... 290	19-1521.12..... 297	19-7030.01..... 301	19-7730.09..... 308	20-4609.00..... 323
19-1311.13..... 290	19-1523.12..... 297	19-7031.01..... 301	19-7751.10..... 306	20-4610.00..... 323
19-1314.13..... 290	19-1525.05..... 297	19-7031.02..... 301	19-7753.10..... 306	20-4610.01..... 323
19-1321.12..... 290	19-1525.07..... 297	19-7032.01..... 301	19-7755.20..... 306	20-4610.02..... 323
19-1325.13..... 290	19-1525.10..... 297	19-7033.01..... 301	19-7755.27..... 306	20-4610.03..... 323
19-1327.12..... 291	19-1542.12..... 298	19-7033.02..... 301	19-7757.08..... 305	20-4610.04..... 323
19-1330.13..... 291	19-1544.12..... 298	19-7050.07..... 305	19-7801.09..... 304	20-4610.05..... 323
19-1331.11..... 291	19-1546.13..... 298	19-7052.07..... 305	19-7810.01..... 303	20-4611.00..... 323
19-1332.12..... 291	19-1548.13..... 298	19-7054.10..... 305	19-7810.02..... 303	20-4612.00..... 323
19-1334.12..... 291	19-1583.07..... 298	19-7061.07..... 302	19-7812.10..... 303	20-4612.01..... 323
19-1336.12..... 291	19-1589.13..... 298	19-7063.07..... 302	19-7814.10..... 303	20-4612.02..... 323
19-1340.13..... 291	19-1590.06..... 298	19-7081.07..... 302	19-7816.11..... 304	20-4612.03..... 323
19-1342.12..... 291	19-1593.09..... 298	19-7091.07..... 302	19-7818.11..... 304	20-4612.04..... 323
19-1351.01..... 292	19-1602.01..... 299	19-7093.07..... 302	19-7820.11..... 304	20-4612.05..... 323
19-1351.02..... 292	19-1602.02..... 299	19-7095.07..... 302	19-7840.09..... 303	20-4614.00..... 323
19-1351.03..... 292	19-1602.03..... 299	19-7102.08..... 304	19-7842.09..... 303	20-4615.00..... 323
19-1353.13..... 291	19-1605.12..... 299	19-7104.08..... 304	19-7875.05..... 306	20-4615.01..... 323
19-1355.13..... 291	19-1605.34..... 299	19-7106.08..... 304	19-7910.09..... 315	20-4615.02..... 323
19-1357.13..... 292	19-1605.56..... 299	19-7108.08..... 304	19-7916.08..... 315	20-4615.03..... 323
19-1363.01..... 292	19-1608.12..... 299	19-7120.08..... 301	19-7924.09..... 315	20-4615.04..... 323
19-1363.02..... 292	19-1614.00..... 299	19-7121.08..... 301	19-7936.09..... 315	20-4615.05..... 323
19-1370.12..... 292	19-1614.01..... 299	19-7122.08..... 301	19-7940.09..... 315	20-4616.00..... 323
19-1372.13..... 292	19-1614.12..... 299	19-7123.08..... 301	19-7951.10..... 315	20-4617.00..... 323
19-1373.13..... 292	19-1614.23..... 299	19-7210.01..... 310		20-4617.01..... 323
19-1376.13..... 292	19-1614.34..... 299	19-7210.03..... 310	20	20-4617.02..... 323
19-1377.13..... 293	19-1614.45..... 299	19-7210.05..... 310	20-2010.00..... 318	20-4617.03..... 323
19-1380.13..... 293	19-1614.56..... 299	19-7210.10..... 310	20-2010.30..... 318	20-4617.04..... 323
19-1381.13..... 293	19-1614.67..... 299	19-7210.15..... 310	20-2010.45..... 318	20-4617.05..... 323
19-1383.13..... 293	19-1614.78..... 299	19-7211.05..... 310	20-2010.55..... 318	20-4631.00..... 322
19-1386.13..... 293	19-1616.00..... 299	19-7211.10..... 310	20-2010.65..... 318	20-4631.01..... 322
19-1402.05..... 293	19-1616.01..... 299	19-7211.15..... 310	20-2010.75..... 318	20-4631.02..... 322
19-1402.10..... 293	19-1616.12..... 299	19-7231.07..... 302	20-2012.00..... 318	20-4631.03..... 322
19-1402.15..... 293	19-1616.23..... 299	19-7233.07..... 302	20-2012.55..... 318	20-4631.04..... 322
19-1402.18..... 293	19-1616.34..... 299	19-7235.07..... 303	20-2012.65..... 318	20-4631.05..... 322
19-1402.20..... 293	19-1616.45..... 299	19-7237.07..... 303	20-2012.75..... 318	20-4633.01..... 322
19-1402.25..... 293	19-1616.56..... 299	19-7240.07..... 310	20-2014.00..... 318	20-4633.02..... 322
19-1402.35..... 293	19-1616.67..... 299	19-7242.10..... 310	20-2014.45..... 318	20-4633.03..... 322
19-1402.40..... 293	19-1616.78..... 299	19-7244.10..... 310	20-2014.55..... 318	20-4633.04..... 322
19-1402.45..... 293	19-1750.17..... 315	19-7250.08..... 311	20-2014.65..... 318	20-4633.05..... 322
19-1404.10..... 294	19-2810.00..... 314	19-7252.08..... 311	20-2014.75..... 318	20-4650.18..... 323
19-1404.20..... 294	19-2850.50..... 314	19-7253.08..... 311	20-2015.00..... 318	20-4651.16..... 323
19-1404.25..... 294	19-2850.55..... 314	19-7255.10..... 311	20-2015.45..... 318	20-4653.16..... 323
19-1404.30..... 294	19-2850.60..... 314	19-7257.10..... 311	20-2015.55..... 318	20-4660.15..... 323
19-1404.35..... 294	19-2850.65..... 314	19-7360.01..... 312	20-2015.65..... 318	20-4662.18..... 324
19-1407.13..... 295	19-2850.70..... 314	19-7360.02..... 312	20-2015.75..... 318	20-4664.17..... 324
19-1410.01..... 294	19-2850.80..... 314	19-7362.11..... 312	20-2018.00..... 319	20-4665.17..... 324
19-1410.02..... 294	19-2850.90..... 314	19-7405.10..... 309	20-2018.50..... 319	20-4670.12..... 324
19-1412.01..... 294	19-2851.00..... 314	19-7411.10..... 308	20-2018.60..... 319	20-4671.12..... 324
19-1412.02..... 294	19-2851.01..... 314	19-7412.10..... 308	20-2018.70..... 319	20-4680.01..... 324
19-1414.02..... 295	19-3515.28..... 313	19-7421.10..... 309	20-2018.80..... 319	20-4680.02..... 324
19-1420.01..... 294	19-3516.28..... 313	19-7423.10..... 309	20-2030.04..... 319	20-4680.03..... 324
19-1420.02..... 294	19-3517.45..... 313	19-7427.07..... 308	20-2036.03..... 319	20-4690.01..... 325
19-1420.03..... 294	19-3518.00..... 313	19-7451.10..... 309	20-3570.01..... 320	20-4690.02..... 325
19-1424.13..... 295	19-3519.00..... 313	19-7453.10..... 309	20-3570.02..... 320	20-4692.01..... 325
19-1441.01..... 295	19-3520.00..... 313	19-7455.10..... 309	20-3570.03..... 320	20-4692.02..... 325
19-1441.02..... 295	19-3521.00..... 313	19-7457.09..... 308	20-3570.04..... 320	20-4692.03..... 325
19-1443.13..... 295	19-3910.00..... 314	19-7463.07..... 309	20-3570.05..... 320	20-4692.04..... 325
19-1445.13..... 295	19-3912.00..... 314	19-7475.06..... 309	20-3571.00..... 320	20-4701.12..... 325
19-1447.13..... 295	19-5010.05..... 308	19-7477.06..... 309	20-3874.01..... 321	20-4703.12..... 325
19-1449.01..... 295	19-5010.10..... 308	19-7570.10..... 305	20-4075.00..... 321	20-4706.14..... 325
19-1449.02..... 295	19-5012.05..... 308	19-7571.10..... 306	20-4076.01..... 321	20-4706.16..... 325
19-1461.13..... 296	19-5012.10..... 308	19-7576.10..... 305	20-4091.00..... 321	20-4720.16..... 326
19-1462.13..... 296	19-5020.11..... 307	19-7609.01..... 312	20-4191.00..... 322	20-4722.17..... 326
19-1467.13..... 296	19-5022.11..... 307	19-7609.02..... 312		20-4725.02..... 326

N

Nummernverzeichnis
Index of Numbers
Index des numéros de références
Indice de números de referencias

20-4841.12	326	20-5143.00	331	20-5563.00	334	20-6143.03	337	21-6571.14	344	
20-4841.14	326	20-5145.00	331	20-5565.00	334	20-6143.06	337	21-6573.14	344	
20-4843.14	326	20-5147.00	331	20-5567.00	334	20-6143.10	337	21-6581.01	345	
20-4845.12	326	20-5149.00	331	20-5586.00	334	20-6145.03	337	21-6581.02	345	
20-4851.10	327	20-5210.00	332	20-5587.00	334	20-6145.06	337	21-6581.03	345	
20-4853.11	327	20-5211.00	332	20-5588.00	334	20-6145.10	337	21-6585.18	345	
20-4855.08	328	20-5213.00	332	20-5589.00	334	20-6147.03	337	21-6591.01	345	
20-4857.08	328	20-5214.00	332	20-5650.00	334	20-6147.06	337	21-6591.02	345	
20-4861.08	327	20-5215.00	332	20-5651.00	334	20-6147.10	337	21-6591.03	345	
20-4861.14	327	20-5216.00	332	20-5653.00	334	20-6151.16	337	21-6591.04	345	
20-4861.16	327	20-5217.00	332	20-5654.00	334	20-6153.16	337	21-6595.01	345	
20-4863.08	327	20-5219.00	332	20-5655.00	334	20-6155.16	337	21-6595.02	345	
20-4863.14	327	20-5220.00	332	20-5657.00	334	20-6157.16	337	21-6597.01	345	
20-4865.08	327	20-5221.00	332	20-5659.00	334	20-6200.01	337	21-6597.02	345	
20-4867.20	327	20-5222.00	332	20-5660.00	334	20-6200.02	337	21-6630.25	346	
20-4867.25	327	20-5223.00	332	20-5662.00	334	20-6202.01	337	21-6630.30	346	
20-4867.30	327	20-5225.00	332	20-5663.00	334	20-6202.02	337	21-6630.35	346	
20-4869.30	327	20-5227.00	332	20-5665.00	334	20-6266.35	338	21-6630.40	346	
20-4871.08	328	20-5228.00	332	20-5667.00	334	20-6266.40	338	21-6630.50	346	
20-4873.08	327	20-5229.00	332	20-5686.00	334	20-6266.45	338	21-6630.60	346	
20-4875.08	328	20-5231.00	332	20-5687.00	334	20-6266.50	338	21-6631.01	346	
20-5010.40	328	20-5233.00	332	20-5688.00	334	20-6302.16	338	21-6631.02	346	
20-5012.55	328	20-5234.00	332	20-5689.00	334	20-6303.16	338	21-6631.25	346	
20-5013.55	328	20-5235.00	332	20-6001.01	335	20-6305.16	338	21-6631.30	346	
20-5015.55	328	20-5237.00	332	20-6001.02	335	20-6307.20	338	21-6631.35	346	
20-5017.55	328	20-5239.00	332	20-6003.15	335	20-6310.02	338	21-6631.40	346	
20-5020.70	328	20-5240.00	332	20-6004.15	335	20-6310.03	338	21-6631.50	346	
20-5021.70	328	20-5241.00	332	20-6005.15	335	20-6312.13	338	21-6632.25	346	
20-5022.70	328	20-5243.00	332	20-6006.35	335			21-6632.30	346	
20-5050.40	329	20-5245.00	332	20-6009.10	335			21-6632.35	346	
20-5070.70	329	20-5246.00	333	20-6009.14	335			21-6632.40	346	
20-5052.40	329	20-5247.00	333	20-6009.16	335	21	21-6450.01	340	21-6632.50	346
20-5053.60	329	20-5248.00	333	20-6009.20	335		21-6450.02	340	21-6635.05	346
20-5055.60	329	20-5249.00	333	20-6009.26	335		21-6450.03	340	21-6635.07	346
20-5057.40	329	20-5310.00	332	20-6009.28	335		21-6450.04	340	21-6635.09	346
20-5059.40	329	20-5311.00	332	20-6009.30	335		21-6450.05	340	21-6635.11	346
20-5060.35	329	20-5313.00	332	20-6110.15	336		21-6450.06	340	21-6637.05	346
20-5062.45	329	20-5314.00	332	20-6111.15	336		21-6450.07	340	21-6637.07	346
20-5063.45	329	20-5315.00	332	20-6113.15	336		21-6460.01	340	21-6637.09	346
20-5065.45	329	20-5316.00	332	20-6115.15	336		21-6460.02	340	21-6651.21	347
20-5067.50	329	20-5317.00	332	20-6120.03	336		21-6460.03	340	21-6703.03	347
20-5069.50	329	20-5319.00	332	20-6120.06	336		21-6502.01	340	21-6703.04	347
20-5070.50	329	20-5320.00	332	20-6120.10	336		21-6502.02	340	21-6703.05	347
20-5071.40	329	20-5322.00	333	20-6122.03	336		21-6502.03	340	21-6703.06	347
20-5073.30	329	20-5323.00	333	20-6122.06	336		21-6512.01	340	21-6705.01	347
20-5075.60	329	20-5325.00	333	20-6122.10	336		21-6512.02	340	21-6705.02	347
20-5077.60	329	20-5327.00	333	20-6122.12	336		21-6512.03	340	21-6711.10	348
20-5081.30	329	20-5328.00	333	20-6122.15	336		21-6513.03	341	21-6711.25	348
20-5083.30	329	20-5329.00	333	20-6122.20	336		21-6516.13	341	21-6711.40	348
20-5085.01	330	20-5331.00	333	20-6122.25	336		21-6520.35	341	21-6715.20	348
20-5085.02	330	20-5333.00	333	20-6124.03	336		21-6520.50	341	21-6720.20	347
20-5087.01	330	20-5334.00	333	20-6124.06	336		21-6520.75	341	21-6723.19	348
20-5087.02	330	20-5335.00	333	20-6124.10	336		21-6520.90	341	21-6725.19	348
20-5110.00	330	20-5337.00	333	20-6124.12	336		21-6524.35	342	21-6740.15	349
20-5112.00	330	20-5339.00	333	20-6124.15	336		21-6524.50	342	21-6740.18	349
20-5113.00	330	20-5340.00	333	20-6124.20	336		21-6524.75	342	21-6740.20	349
20-5115.00	330	20-5341.00	333	20-6124.25	336		21-6524.90	342	21-6741.03	349
20-5117.00	330	20-5343.00	333	20-6125.05	336		21-6526.35	342	21-6751.26	349
20-5119.00	330	20-5345.00	333	20-6125.10	336		21-6526.50	342	21-6752.24	349
20-5120.00	331	20-5346.00	333	20-6130.03	337		21-6526.75	342	21-6755.03	349
20-5122.00	331	20-5347.00	333	20-6130.06	337		21-6526.90	342	21-6770.16	350
20-5123.00	331	20-5348.00	333	20-6130.10	337		21-6531.19	341	21-6771.16	350
20-5125.00	331	20-5349.00	333	20-6132.03	337		21-6539.12	343	21-6772.16	350
20-5127.00	331	20-5550.00	334	20-6132.06	337		21-6539.14	343	21-6773.16	350
20-5129.00	331	20-5551.00	334	20-6132.10	337		21-6539.16	343	21-6774.15	350
20-5130.00	331	20-5553.00	334	20-6133.05	336		21-6539.18	343	21-6775.19	350
20-5132.00	331	20-5554.00	334	20-6133.10	336		21-6551.15	343	21-6776.16	350
20-5133.00	331	20-5555.00	334	20-6135.05	336		21-6551.18	343	21-6779.16	350
20-5135.00	331	20-5556.00	334	20-6135.10	336		21-6554.20	343	21-6780.15	350
20-5137.00	331	20-5557.00	334	20-6136.15	336		21-6561.16	344	21-6782.15	351
20-5139.00	331	20-5559.00	334	20-6137.15	336		21-6561.20	344	21-6784.15	351
20-5139.08	331	20-5560.00	334	20-6141.03	337		21-6565.20	344	21-6785.15	351
20-5140.00	331	20-5561.00	334	20-6141.06	337		21-6567.18	344	21-6790.03	351
20-5142.00	331	20-5562.00	334	20-6141.10	337		21-6569.18	344	21-6790.04	351

Nummernverzeichnis
Index of Numbers
Index des numéros de références
Indice de números de referencias

21-6790.05..... 351	21-6956.16..... 358	22-7581.11..... 367	23-7970.00..... 376	24-8160.07..... 380
21-6792.03..... 351	21-6957.17..... 358	22-7581.13..... 367	23-7990.02..... 376	24-8170.08..... 380
21-6792.04..... 351	21-6959.20..... 358	22-7581.15..... 367	23-7990.05..... 376	24-8170.10..... 380
21-6792.05..... 351	21-6960.18..... 358	22-7585.09..... 366	23-7990.10..... 376	24-8170.12..... 380
21-6798.16..... 351	21-6962.18..... 358	22-7585.11..... 366	23-7993.00..... 376	24-8170.14..... 380
21-6810.04..... 352	21-6971.23..... 359	22-7585.13..... 366	23-7993.45..... 376	24-8170.16..... 380
21-6810.05..... 352	21-6972.23..... 359	22-7585.15..... 366	23-7993.90..... 376	24-8170.18..... 380
21-6813.19..... 352	21-6973.23..... 359	22-7610.00..... 367		24-8170.20..... 380
21-6815.18..... 352	21-6975.23..... 359	22-7610.01..... 367	24	24-8170.22..... 380
21-6817.19..... 352	21-6995.15..... 359	22-7610.02..... 367		24-8170.24..... 380
21-6819.19..... 352	21-7001.21..... 360	22-7610.03..... 367	24-8001.22..... 378	24-8170.26..... 380
21-6821.23..... 352	21-7007.01..... 360	22-7610.04..... 367	24-8003.22..... 378	24-8170.28..... 380
21-6823.22..... 352	21-7007.02..... 360	22-7610.05..... 367	24-8011.18..... 378	24-8170.30..... 380
21-6825.16..... 353	21-7007.03..... 360	22-7610.10..... 367	24-8015.01..... 378	24-8172.08..... 380
21-6825.19..... 353	21-7007.04..... 360	22-7615.00..... 368	24-8015.02..... 378	24-8172.10..... 380
21-6826.22..... 352	21-7007.05..... 360	22-7615.01..... 368	24-8015.03..... 378	24-8172.12..... 380
21-6828.21..... 353	21-7007.06..... 360	22-7615.02..... 368	24-8015.04..... 378	24-8172.14..... 380
21-6830.22..... 353	21-7020.01..... 360	22-7615.03..... 368	24-8021.24..... 378	24-8172.16..... 380
21-6850.04..... 353	21-7020.02..... 360	22-7615.10..... 368	24-8030.00..... 379	24-8172.18..... 380
21-6851.04..... 353	21-7020.03..... 360	22-7620.00..... 368	24-8031.20..... 379	24-8172.20..... 380
21-6854.04..... 353	21-7020.04..... 360	22-7620.01..... 368	24-8032.20..... 379	24-8172.22..... 380
21-6854.07..... 353	21-7020.05..... 360	22-7620.02..... 368	24-8032.30..... 379	24-8172.24..... 380
21-6854.09..... 353	21-7020.06..... 360	22-7620.03..... 368	24-8032.40..... 379	24-8172.26..... 380
21-6854.12..... 353	21-7030.01..... 361	22-7620.10..... 368	24-8032.50..... 379	24-8172.28..... 380
21-6855.06..... 353	21-7030.02..... 361	22-7660.10..... 369	24-8032.60..... 379	24-8172.30..... 380
21-6858.04..... 354	21-7030.03..... 361	22-7665.10..... 369	24-8050.00..... 379	24-8174.12..... 380
21-6858.07..... 354	21-7030.04..... 361	22-7671.01..... 369	24-8052.00..... 379	24-8176.10..... 380
21-6858.09..... 354	21-7036.01..... 361	22-7671.02..... 369	24-8054.00..... 379	
21-6858.12..... 354	21-7036.02..... 361	22-7671.03..... 369	24-8055.00..... 379	25
21-6860.04..... 354	21-7036.03..... 361	22-7701.22..... 369	24-8057.00..... 379	
21-6860.07..... 354	21-7036.04..... 361	22-7701.23..... 369	24-8058.02..... 379	25-1110.16..... 382
21-6860.12..... 354	21-7041.01..... 362	22-7701.24..... 369	24-8058.03..... 379	25-1110.26..... 382
21-6870.04..... 354	21-7041.02..... 362	22-7703.22..... 369	24-8060.02..... 379	25-1110.23..... 382
21-6870.05..... 354	21-7041.03..... 362	22-7703.23..... 369	24-8060.03..... 379	25-1110.33..... 382
21-6870.06..... 354	21-7042.01..... 362	22-7703.24..... 369	24-8062.00..... 379	25-1111.16..... 382
21-6870.07..... 354	21-7042.02..... 362		24-8064.01..... 379	25-1111.26..... 382
21-6872.10..... 355	21-7042.03..... 362	23	24-8064.02..... 379	25-1111.23..... 382
21-6872.12..... 355		23-7803.18..... 372	24-8066.00..... 379	25-1111.33..... 382
21-6872.14..... 355	22	23-7803.20..... 372	24-8068.01..... 379	25-1112.16..... 382
21-6872.16..... 355		23-7803.22..... 372	24-8068.02..... 379	25-1112.26..... 382
21-6873.01..... 354	22-7502.16..... 364	23-7809.24..... 372	24-8068.03..... 379	25-1112.23..... 382
21-6873.02..... 354	22-7505.16..... 364	23-7811.23..... 372	24-8068.04..... 379	25-1112.33..... 382
21-6873.03..... 354	22-7507.19..... 364	23-7831.22..... 372	24-8070.00..... 379	25-1113.16..... 382
21-6882.05..... 355	22-7509.19..... 364	23-7833.22..... 372	24-8072.01..... 379	25-1113.26..... 382
21-6884.04..... 355	22-7511.15..... 364	23-7835.23..... 372	24-8072.02..... 379	25-1113.23..... 382
21-6884.06..... 355	22-7515.01..... 364	23-7839.25..... 372	24-8074.00..... 379	25-1113.33..... 382
21-6884.08..... 355	22-7515.02..... 364	23-7843.24..... 372	24-8076.00..... 379	25-1120.16..... 382
21-6886.16..... 355	22-7517.11..... 364	23-7851.19..... 372	24-8130.01..... 380	25-1120.26..... 382
21-6887.16..... 355	22-7519.14..... 364	23-7855.22..... 373	24-8140.01..... 380	25-1120.33..... 382
21-6889.16..... 355	22-7527.14..... 365	23-7867.22..... 373	24-8150.01..... 380	25-1120.33..... 382
21-6902.16..... 356	22-7527.16..... 364	23-7881.19..... 373	24-8160.01..... 380	25-1121.16..... 382
21-6904.18..... 356	22-7527.18..... 364	23-7883.19..... 373	24-8130.02..... 380	25-1121.26..... 382
21-6907.18..... 356	22-7529.12..... 364	23-7885.19..... 373	24-8140.02..... 380	25-1121.23..... 382
21-6907.19..... 356	22-7529.14..... 364	23-7887.19..... 373	24-8150.02..... 380	25-1121.33..... 382
21-6911.21..... 356	22-7529.16..... 364	23-7891.19..... 373	24-8160.02..... 380	25-1122.16..... 382
21-6913.21..... 356	22-7530.11..... 364	23-7893.19..... 373	24-8130.03..... 380	25-1122.26..... 382
21-6914.16..... 356	22-7535.19..... 364	23-7902.19..... 374	24-8140.03..... 380	25-1122.23..... 382
21-6916.16..... 356	22-7550.16..... 364	23-7903.19..... 374	24-8150.03..... 380	25-1122.33..... 382
21-6918.21..... 356	22-7550.18..... 364	23-7905.18..... 374	24-8160.03..... 380	25-1123.16..... 382
21-6920.21..... 357	22-7555.16..... 364	23-7907.21..... 374	24-8130.04..... 380	25-1123.26..... 382
21-6922.01..... 357	22-7555.99..... 364	23-7909.20..... 374	24-8140.04..... 380	25-1123.23..... 382
21-6922.03..... 357	22-7565.12..... 366	23-7911.21..... 374	24-8150.04..... 380	25-1123.33..... 382
21-6922.05..... 357	22-7565.14..... 366	23-7913.21..... 374	24-8160.04..... 380	25-1130.16..... 382
21-6922.07..... 357	22-7567.12..... 366	23-7919.22..... 374	24-8130.05..... 380	25-1130.23..... 382
21-6922.09..... 357	22-7570.16..... 366	23-7919.22..... 374	24-8140.05..... 380	25-1131.16..... 382
21-6926.16..... 357	22-7570.19..... 366	23-7931.14..... 375	24-8150.05..... 380	25-1131.23..... 382
21-6927.16..... 357	22-7572.13..... 366	23-7950.28..... 375	24-8160.05..... 380	25-1140.16..... 382
21-6929.16..... 357	22-7574.09..... 366	23-7952.28..... 375	24-8130.06..... 380	25-1140.23..... 382
21-6932.19..... 358	22-7574.11..... 366	23-7956.28..... 375	24-8140.06..... 380	25-1141.16..... 382
21-6934.19..... 358	22-7574.13..... 366	23-7957.40..... 375	24-8150.06..... 380	25-1141.23..... 382
21-6935.01..... 358	22-7574.15..... 366	23-7957.50..... 375	24-8160.06..... 380	25-1142.16..... 382
21-6935.02..... 358	22-7580.11..... 367	23-7957.03..... 375	24-8130.07..... 380	25-1142.23..... 382
21-6951.16..... 359	22-7580.13..... 367	23-7959.00..... 375	24-8140.07..... 380	25-1143.16..... 382
21-6956.14..... 358	22-7580.15..... 367	23-7960.00..... 375	24-8150.07..... 380	25-1143.23..... 382

Nummernverzeichnis
Index of Numbers
Index des numéros de références
Indice de números de referencias

30-1519.12.....	427	32-1060.01.....	435	32-1510.25.....	441	32-1620.19.....	443	32-1821.01.....	453
30-1519.14.....	427	32-1060.02.....	435	32-1510.30.....	441	32-1620.21.....	443	32-1822.00.....	453
30-1519.16.....	427	32-1060.03.....	435	32-1510.35.....	441	32-1620.23.....	443	32-1824.01.....	454
30-1519.18.....	427	32-1080.01.....	436	32-1510.40.....	441	32-1620.25.....	443	32-1824.02.....	454
30-1519.20.....	427	32-1080.02.....	436	32-1513.20.....	441	32-1624.08.....	443	32-1824.03.....	454
30-1519.22.....	427	32-1080.03.....	436	32-1513.25.....	441	32-1624.13.....	443	32-1824.04.....	454
30-1519.24.....	427	32-1090.01.....	436	32-1513.30.....	441	32-1625.08.....	443	32-1824.11.....	454
		32-1090.02.....	436	32-1513.35.....	441	32-1626.08.....	443	32-1824.12.....	454
31		32-1110.01.....	436	32-1513.40.....	441	32-1626.13.....	443	32-1824.13.....	454
		32-1110.02.....	436	32-1515.40.....	441	32-1630.10.....	444	32-1824.14.....	454
31-1105.22.....	428	32-1110.03.....	436	32-1519.28.....	441	32-1630.12.....	444	32-1825.04.....	453
31-1110.15.....	428	32-1111.01.....	436	32-1519.38.....	441	32-1630.14.....	444	32-1826.00.....	453
31-1115.15.....	428	32-1111.02.....	436	32-1551.10.....	441	32-1630.16.....	444	32-1827.00.....	455
31-1121.22.....	428	32-1111.03.....	436	32-1560.24.....	441	32-1630.18.....	444	32-1828.00.....	455
31-1125.17.....	428	32-1112.01.....	436	32-1604.14.....	442	32-1630.20.....	444	32-1830.00.....	455
31-1130.19.....	428	32-1112.02.....	436	32-1604.26.....	442	32-1635.06.....	444	32-1832.01.....	456
31-1147.00.....	429	32-1112.03.....	436	32-1605.14.....	442	32-1636.08.....	444	32-1832.02.....	456
31-1150.15.....	429	32-1120.01.....	437	32-1606.14.....	442	32-1641.34.....	444	32-1832.03.....	456
31-1160.00.....	429	32-1120.02.....	437	32-1606.26.....	442	32-1643.29.....	444	32-1832.04.....	456
31-1210.22.....	430	32-1121.01.....	437	32-1610.01.....	442	32-1645.29.....	444	32-1832.11.....	456
31-1212.16.....	430	32-1121.02.....	437	32-1610.02.....	442	32-1702.25.....	445	32-1832.12.....	456
31-1212.19.....	430	32-1122.01.....	437	32-1610.03.....	442	32-1704.25.....	445	32-1832.13.....	456
31-1212.22.....	430	32-1122.02.....	437	32-1610.04.....	442	32-1705.24.....	445	32-1832.14.....	456
31-1220.05.....	430	32-1130.01.....	437	32-1610.05.....	442	32-1707.28.....	445	32-1841.17.....	457
31-1220.10.....	430	32-1130.02.....	437	32-1610.06.....	442	32-1708.17.....	445	32-1843.27.....	457
31-1220.14.....	430	32-1130.03.....	437	32-1610.07.....	442	32-1710.18.....	445	32-1845.01.....	457
31-1220.20.....	430	32-1131.01.....	437	32-1610.08.....	442	32-1712.20.....	446	32-1845.02.....	457
31-1224.21.....	430	32-1131.02.....	437	32-1610.09.....	442	32-1714.24.....	446	32-1845.03.....	457
31-1224.27.....	430	32-1131.03.....	437	32-1610.10.....	442	32-1715.24.....	446	32-1850.00.....	457
31-1251.01.....	431	32-1132.01.....	437	32-1610.11.....	442	32-1724.06.....	446	32-1902.01.....	458
31-1251.02.....	431	32-1132.02.....	437	32-1610.12.....	442	32-1724.08.....	446	32-1902.02.....	458
31-1251.03.....	431	32-1132.03.....	437	32-1610.13.....	442	32-1724.10.....	446	32-1902.03.....	458
31-1261.41.....	431	32-1140.01.....	438	32-1610.14.....	442	32-1725.06.....	446	32-1902.04.....	458
31-1263.30.....	431	32-1140.02.....	438	32-1610.15.....	442	32-1725.08.....	446	32-1902.05.....	458
31-1301.28.....	432	32-1140.03.....	438	32-1610.16.....	442	32-1725.10.....	446	32-1902.06.....	458
31-1301.35.....	432	32-1141.01.....	438	32-1610.17.....	442	32-1731.23.....	447	32-1904.27.....	458
31-1301.42.....	432	32-1141.02.....	438	32-1610.18.....	442	32-1732.21.....	447	32-1912.05.....	459
31-1302.28.....	432	32-1141.03.....	438	32-1610.19.....	442	32-1733.21.....	447	32-1912.06.....	459
31-1302.35.....	432	32-1142.01.....	438	32-1610.20.....	442	32-1736.28.....	447	32-1912.07.....	459
31-1302.42.....	432	32-1142.02.....	438	32-1610.21.....	442	32-1739.26.....	447	32-1912.08.....	459
31-1303.28.....	432	32-1142.03.....	438	32-1610.22.....	442	32-1740.27.....	447	32-1912.09.....	459
31-1303.35.....	432	32-1150.00.....	438	32-1610.23.....	442	32-1742.20.....	447	32-1912.11.....	459
31-1303.42.....	432	32-1151.00.....	438	32-1610.24.....	442	32-1743.32.....	447	32-1912.12.....	459
31-1304.28.....	432	32-1152.00.....	438	32-1610.25.....	442	32-1745.27.....	447	32-1912.14.....	459
31-1304.35.....	432	32-1160.01.....	439	32-1610.26.....	442	32-1747.23.....	447	32-1914.05.....	459
31-1304.42.....	432	32-1160.02.....	439	32-1610.27.....	442	32-1749.25.....	447	32-1914.06.....	459
31-1311.23.....	432	32-1161.01.....	439	32-1610.28.....	442	32-1759.26.....	447	32-1914.07.....	459
31-1311.33.....	432	32-1161.02.....	439	32-1610.29.....	442	32-1765.28.....	449	32-1914.08.....	459
31-1311.40.....	432	32-1162.01.....	439	32-1610.30.....	442	32-1767.26.....	449	32-1914.09.....	459
31-1321.23.....	432	32-1162.02.....	439	32-1615.01.....	442	32-1780.32.....	449	32-1914.11.....	459
31-1321.33.....	432	32-1171.01.....	439	32-1615.02.....	442	32-1781.32.....	449	32-1914.12.....	459
31-1321.40.....	432	32-1171.02.....	439	32-1615.03.....	442	32-1782.32.....	449	32-1914.14.....	459
31-1402.21.....	431	32-1171.03.....	439	32-1615.04.....	442	32-1783.32.....	449	32-1913.05.....	459
		32-1181.01.....	439	32-1615.05.....	442	32-1784.28.....	449	32-1913.06.....	459
		32-1181.02.....	439	32-1615.06.....	442	32-1784.28.....	449	32-1913.07.....	459
		32-1181.03.....	439	32-1615.07.....	442	32-1790.04.....	450	32-1913.08.....	459
		32-1191.00.....	439	32-1615.08.....	442	32-1792.01.....	450	32-1913.08.....	459
		32-1191.01.....	439	32-1615.09.....	442	32-1792.02.....	450	32-1913.09.....	459
		32-1191.02.....	439	32-1615.10.....	442	32-1792.03.....	450	32-1913.11.....	459
		32-1191.03.....	439	32-1615.11.....	442	32-1792.04.....	450	32-1913.12.....	459
		32-1201.01.....	440	32-1615.12.....	442	32-1794.12.....	450	32-1913.14.....	459
		32-1201.02.....	440	32-1615.13.....	442	32-1794.40.....	450	32-1915.05.....	459
		32-1201.03.....	440	32-1615.14.....	442	32-1796.40.....	450	32-1915.06.....	459
		32-1203.01.....	440	32-1615.15.....	442	32-1801.21.....	451	32-1915.07.....	459
		32-1203.02.....	440	32-1615.16.....	442	32-1804.21.....	451	32-1915.08.....	459
		32-1203.03.....	440	32-1620.01.....	443	32-1804.28.....	451	32-1915.09.....	459
		32-1203.04.....	440	32-1620.03.....	443	32-1805.26.....	451	32-1915.11.....	459
		32-1205.01.....	440	32-1620.05.....	443	32-1806.24.....	451	32-1915.12.....	459
		32-1205.02.....	440	32-1620.07.....	443	32-1809.23.....	451	32-1915.14.....	459
		32-1205.03.....	440	32-1620.09.....	443	32-1811.25.....	451	32-1922.07.....	460
		32-1205.04.....	440	32-1620.11.....	443	32-1813.20.....	452	32-1922.08.....	460
		32-1507.00.....	440	32-1620.13.....	443	32-1815.01.....	452	32-1922.09.....	460
		32-1509.00.....	440	32-1620.15.....	443	32-1815.02.....	452	32-1922.11.....	460
		32-1510.20.....	441	32-1620.17.....	443	32-1817.04.....	452	32-1922.12.....	460
						32-1818.23.....	452	32-1922.14.....	460

Nummernverzeichnis
Index of Numbers
Index des numéros de références
Indice de números de referencias

32-1922.15.....	460	33-1172.40.....	466	35-1123.65.....	476	35-1365.16.....	479
32-1922.16.....	460	33-1180.00.....	467	35-1124.00.....	476	35-1365.19.....	479
32-1922.19.....	460	33-1181.21.....	467	35-1130.18.....	477	35-1365.24.....	479
32-1922.20.....	460	33-1191.33.....	467	35-1130.20.....	477	35-1365.29.....	479
32-1924.07.....	460	33-1193.27.....	467	35-1130.22.....	477	35-1365.34.....	479
32-1924.08.....	460	33-1194.21.....	467	35-1130.25.....	477	35-1365.39.....	479
32-1924.09.....	460	33-1197.09.....	467	35-1130.30.....	477	35-1366.14.....	479
32-1924.11.....	460	33-1189.09.....	467	35-1130.32.....	477	35-1366.16.....	479
32-1924.12.....	460	33-1201.34.....	468	35-1130.40.....	477	35-1366.19.....	479
32-1924.14.....	460	33-1203.30.....	468	35-1130.50.....	477	35-1366.24.....	479
32-1924.15.....	460	33-1205.35.....	468	35-1140.04.....	477	35-1366.29.....	479
32-1924.16.....	460	33-1232.27.....	468	35-1140.06.....	477	35-1366.34.....	479
32-1924.19.....	460	33-1233.27.....	468	35-1140.08.....	477	35-1366.39.....	479
32-1924.20.....	460	33-1234.01.....	468	35-1140.10.....	477	35-1370.14.....	479
32-1925.07.....	460	33-1234.02.....	468	35-1140.12.....	477	35-1370.16.....	479
32-1925.08.....	460	33-1234.03.....	468	35-1140.15.....	477	35-1370.19.....	479
32-1925.09.....	460	33-1235.01.....	468	35-1143.16.....	477	35-1370.24.....	479
32-1925.11.....	460	33-1235.02.....	468	35-1143.17.....	477	35-1370.29.....	479
32-1925.12.....	460	33-1235.03.....	468	35-1143.22.....	477	35-1370.34.....	479
32-1925.14.....	460	33-1242.30.....	469	35-1143.23.....	477	35-1370.39.....	479
32-1925.15.....	460	33-1244.14.....	469	35-1143.24.....	477	35-1371.14.....	479
32-1925.16.....	460	33-1244.18.....	469	35-1143.25.....	477	35-1371.16.....	479
32-1925.19.....	460	33-1244.21.....	469	35-1143.27.....	477	35-1371.19.....	479
32-1925.20.....	460	33-1246.42.....	469	35-1143.29.....	477	35-1371.24.....	479
32-1927.07.....	460	33-1249.28.....	467	35-1143.31.....	477	35-1371.29.....	479
32-1927.08.....	460	33-1250.42.....	470	35-1143.34.....	477	35-1371.34.....	479
32-1927.09.....	460	33-1254.46.....	470	35-1143.38.....	477	35-1371.39.....	479
32-1927.11.....	460	33-1256.25.....	470	35-1143.41.....	477	35-1371.49.....	479
32-1927.12.....	460	33-1259.30.....	470	35-1144.01.....	477	35-1371.59.....	479
32-1927.14.....	460			35-1144.02.....	477	35-1383.08.....	479
32-1927.15.....	460	34		35-1144.03.....	477	35-1383.10.....	479
32-1927.16.....	460	34-1230.15.....	472	35-1144.04.....	477	35-1383.25.....	479
32-1927.19.....	460	34-1241.10.....	472	35-1144.05.....	477	35-1384.08.....	479
32-1927.20.....	460	34-1243.14.....	472	35-1144.06.....	477	35-1384.10.....	479
32-1932.30.....	461	34-1243.14.....	472	35-1144.07.....	477	35-1384.13.....	479
32-1932.35.....	461	34-1245.14.....	472	35-1149.17.....	478	35-1384.15.....	479
32-1932.40.....	461	34-1248.14.....	472	35-1149.25.....	478	35-1384.19.....	479
32-1934.30.....	461	34-1251.10.....	472	35-1149.27.....	478	35-1385.14.....	479
32-1934.35.....	461	34-1258.03.....	472	35-1150.02.....	478	35-1385.16.....	479
32-1934.40.....	461	34-1258.04.....	472	35-1150.05.....	478	35-1385.19.....	479
32-1933.30.....	461	34-1258.05.....	472	35-1150.10.....	478	35-1385.24.....	479
32-1933.35.....	461	34-1258.06.....	472	35-1150.20.....	478	35-1388.14.....	479
32-1933.40.....	461	34-1260.03.....	472	35-1251.10.....	476	35-1388.16.....	479
32-1935.30.....	461	34-1260.04.....	472	35-1252.01.....	478	35-1388.19.....	479
32-1935.35.....	461	34-1260.05.....	472	35-1252.02.....	478	35-1388.24.....	479
32-1935.40.....	461	34-1268.00.....	473	35-1252.03.....	478	35-1388.29.....	479
		34-1270.02.....	473	35-1252.04.....	478	35-1388.34.....	479
33		34-1270.03.....	473	35-1252.05.....	478	35-1388.39.....	479
33-1110.23.....	464	34-1270.04.....	473	35-1252.06.....	478	35-1390.14.....	479
33-1112.30.....	464	34-1270.05.....	473	35-1252.07.....	478	35-1390.16.....	479
33-1115.33.....	464	34-1270.06.....	473	35-1252.08.....	478	35-1390.19.....	479
33-1115.36.....	464	34-1270.07.....	473	35-1252.09.....	478	35-1390.24.....	479
33-1117.30.....	464	34-1270.08.....	473	35-1254.20.....	478	35-1390.29.....	479
33-1118.36.....	464	34-1310.10.....	473	35-1254.26.....	478	35-1390.34.....	479
33-1118.39.....	464	34-1314.10.....	473	35-1254.30.....	478	35-1390.39.....	479
33-1120.41.....	465	34-1315.10.....	473	35-1254.35.....	478	35-1391.14.....	479
33-1125.32.....	464	34-1317.14.....	474	35-1256.22.....	478	35-1391.16.....	479
33-1125.38.....	464	34-1320.14.....	474	35-1256.28.....	478	35-1391.19.....	479
33-1129.36.....	464	34-1323.11.....	474	35-1256.32.....	478	35-1391.24.....	479
33-1129.40.....	464	34-1323.14.....	474	35-1256.37.....	478	35-1391.29.....	479
33-1135.40.....	465	34-1330.13.....	474	35-1256.42.....	478	35-1391.34.....	479
33-1137.40.....	465	34-1335.11.....	474	35-1325.08.....	479	35-1391.39.....	479
33-1145.36.....	465	34-1343.10.....	474	35-1325.10.....	479	35-1395.14.....	479
33-1149.40.....	465	34-1348.10.....	473	35-1325.25.....	479	35-1395.16.....	479
33-1151.39.....	465	34-1349.10.....	473	35-1350.08.....	479	35-1395.19.....	479
33-1153.39.....	465	34-1356.10.....	473	35-1350.10.....	479	35-1395.24.....	479
33-1155.36.....	465	34-1356.12.....	473	35-1350.13.....	479	35-1395.29.....	479
33-1157.36.....	466	34-1369.14.....	473	35-1350.15.....	479	35-1395.34.....	479
33-1158.17.....	466	34-1370.00.....	473	35-1350.19.....	479	35-1395.39.....	479
33-1161.29.....	466			35-1359.14.....	479	35-1395.49.....	479
33-1165.44.....	466	35		35-1359.16.....	479	35-1395.59.....	479
33-1167.40.....	466	35-1120.21.....	476	35-1359.19.....	479	35-2010.26.....	480
33-1170.37.....	466	35-1122.65.....	476	35-1359.24.....	479	35-2010.48.....	480
				35-1365.14.....	479		



ROLAN

ROLAN Instruments GmbH

Ernst-Thälmann-Str. 50
15859 Storkow / Germany
Tel: 0049 33678 44 94 33

www.rolan-instruments.de · info@rolan-instruments.de

Chirurgie • Surgery • Chirurgie • Cirugía

Ausgabe / Edition / Edition / Edición 09-2003

© 2016 ROLAN Instruments GmbH / Printed in Germany