



# ROLAN

Instruments GmbH

Gefäßklemmen • Vascular Clamps





Atraumatische Gefäßklemmen  
 Atraumatic Vascular Clamps  
 Pincas vasculaires atraumatiques  
 Pinzas vasculares atraumáticas  
 Pinze vascolari atraumatiche

**ATRAUMA**



DE BAKEY

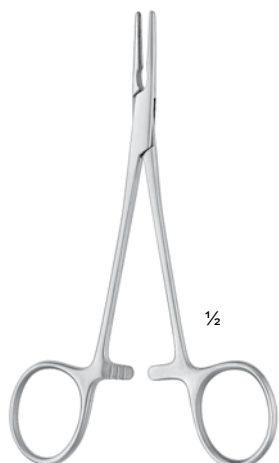

HALSTEAD-MOSQUITO



**36-1620.12**  
12 cm/4<sup>3</sup>/<sub>4</sub>"



**36-1621.12**  
12 cm/4<sup>3</sup>/<sub>4</sub>"



**36-1620.15**  
15 cm/6"



**36-1621.15**  
15 cm/6"



**36-1940.14**  
14 cm/5<sup>1</sup>/<sub>2</sub>"



**36-1940.16**  
16 cm/6<sup>1</sup>/<sub>4</sub>"



**36-1940.18**  
18 cm/7"

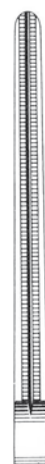

**36-1940.20**  
20 cm/8"



PEAN



**36-1941.14**  
14 cm/5<sup>1</sup>/<sub>2</sub>"



**36-1941.16**  
16 cm/6<sup>1</sup>/<sub>4</sub>"



**36-1941.18**  
18 cm/7"



**36-1941.20**  
20 cm/8"

**ATRAUMA**



DE BAKEY



36-1826.16



36-1827.16

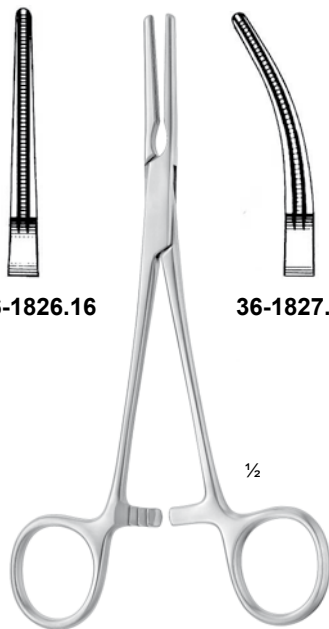

1/2

RANKIN  
16 cm/6 1/4"



**ATRAUMA**



DE BAKEY

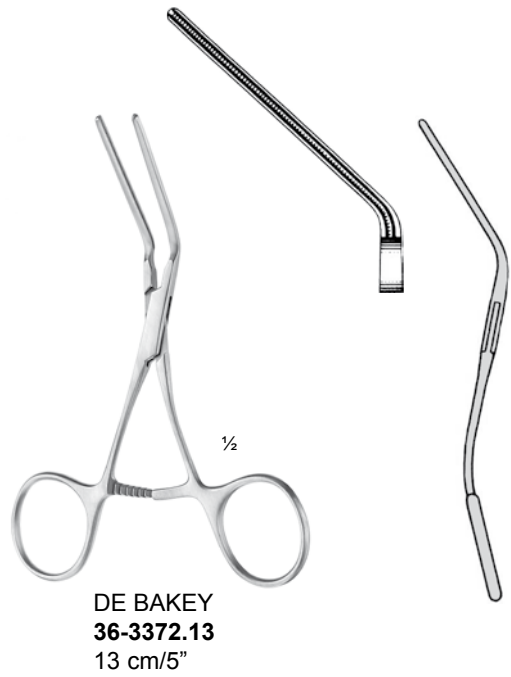
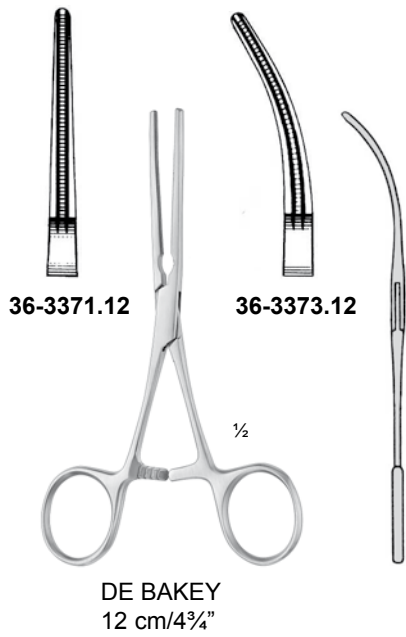

Atraumatische Gefäßklemmen  
 Atraumatic Vascular Clamps  
 Pincés vasculaires atraumatiques  
 Pinzas vasculares atraumáticas  
 Pinze vascolari atraumatiche

**ATRAUMA**



**36-0512.23**  
 23 cm/9"

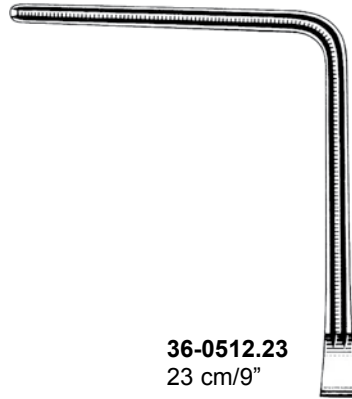

Bronchusklemmen  
 Bronchus Forceps  
 Pincés-Clamps à Bronches  
 Pinzas clamps bronquiales  
 Pinze per bronchi

LEES

1/2



LEES  
**36-0511.25**  
 25 cm/10"

1/2

Coarctationsklemmen  
Coarction Clamps  
Pincès à coarctación  
Pinzas para coarctación  
Pinze per coartazione

**ATRAUMA**



DE BAKEY



POTTS



**36-4122.21**  
21 cm/8 $\frac{1}{4}$ "



**36-4122.22**  
22 cm/8 $\frac{3}{4}$ "

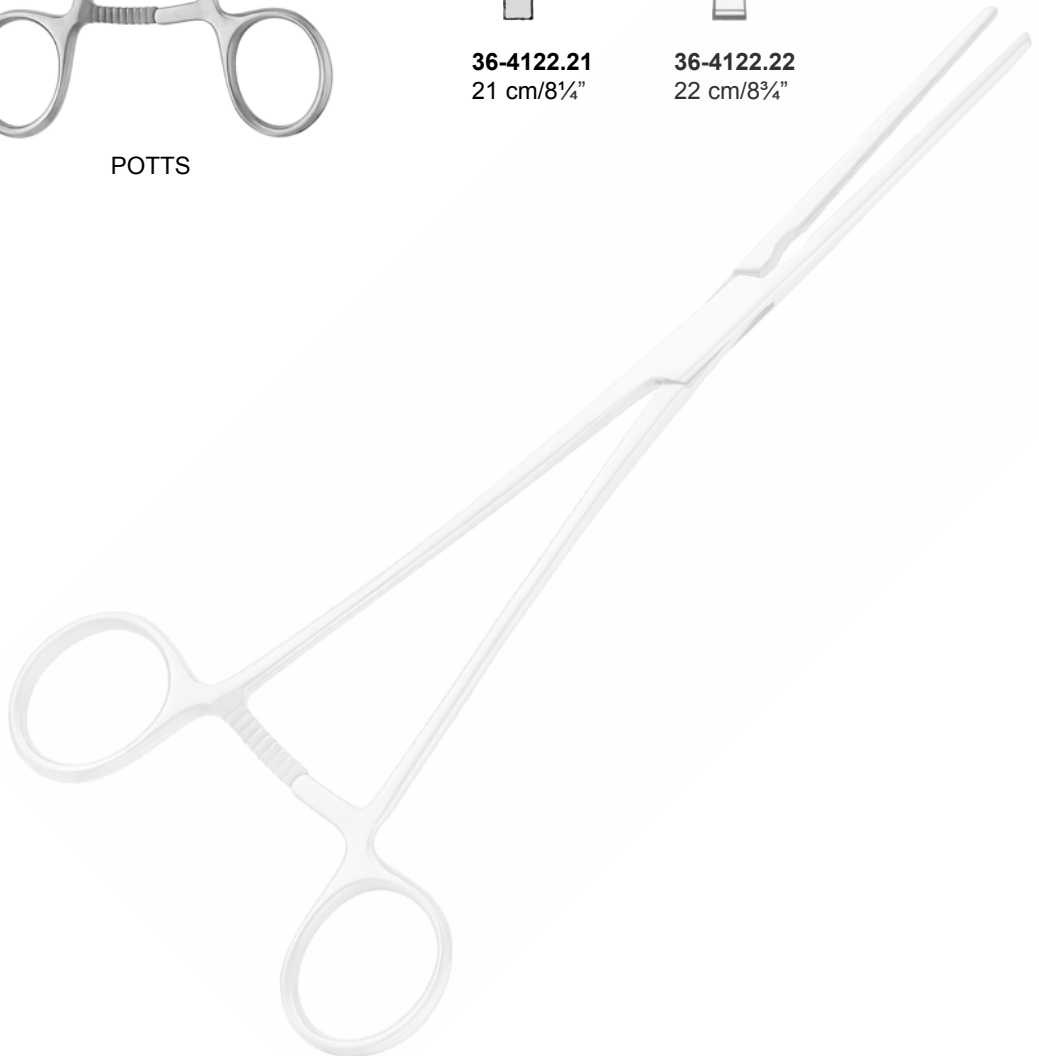

Atraumatische Gefäßklemmen  
 Atraumatic Vascular Clamps  
 Pinces vasculaires atraumatiques  
 Pinzas vasculares atraumáticas  
 Pinze vascolari atraumatiche

**ATRAUMA**



DE BAKEY



POTTS



**36-4119.21**  
21 cm/8<sup>3</sup>/<sub>4</sub>"



**36-4119.22**  
22 cm/8<sup>3</sup>/<sub>4</sub>"



Coarctationsklemmen  
 Coarction Clamps  
 Pinces à coarctacion  
 Pinzas para coarctación  
 Pinze per coartazione



POTTS



**36-4120.21**  
21 cm/8<sup>3</sup>/<sub>4</sub>"



**36-4120.22**  
22 cm/8<sup>3</sup>/<sub>4</sub>"





**ATRAUMA**



DE BAKEY

Anastomosenklemmen  
Anastomosis Clamps  
Pinces à anastomose  
Pinzas para anastomosis  
Pinze per anastomosi



POTTS  
**36-2410.23**  
22 cm/8<sup>3</sup>/<sub>4</sub>"



POTTS



**36-2410.22**  
21 cm/8<sup>1</sup>/<sub>4</sub>"

Atraumatische Gefäßklemmen  
 Atraumatic Vascular Clamps  
 Pincés vasculaires atraumatiques  
 Pinzas vasculares atraumáticas  
 Pinze vascolari atraumatiche

**ATRAUMA**



DE BAKEY

Atraumatische Mehrzweckklemmen  
 Atraumatic Multi-Purpose Clamps  
 Pincés-clamps polyvalentes  
 Pinzas clamps para usos varios  
 Pinze atraumatiche per diversi usi

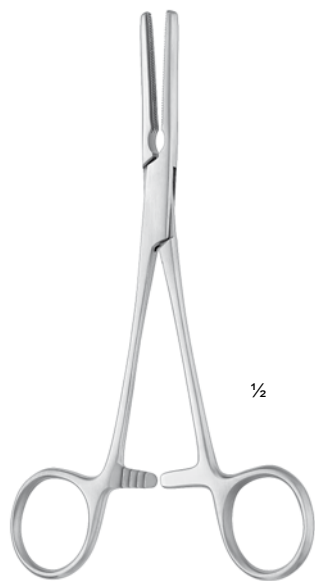

½

DARDIK



0°

**36-3360.00**  
15 cm/6"



15°

**36-3360.15**  
15 cm/6"



30°

**36-3360.30**  
15 cm/6"



45°

**36-3360.45**  
15 cm/6"



90°

**36-3360.90**  
14 cm/5½"



0°

**36-3361.00**  
16 cm/6¼"

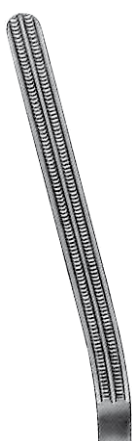

15°

**36-3361.15**  
16 cm/6¼"

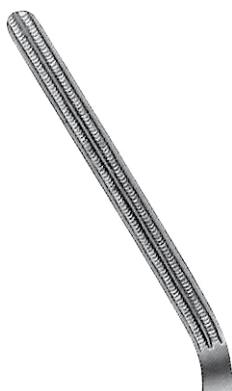

30°

**36-3361.30**  
16 cm/6¼"



45°

**36-3361.45**  
16 cm/6¼"



90°

**36-3361.90**  
17 cm/6¾"

Peripheal-Gefäßklemmen  
 Peripheal Vascular Clamps  
 Pincès-clamps, vasculaires périphériques  
 Pinzas para vasos periféricos  
 Pinze vascolari periferali

**ATRAUMA**



DE BAKEY



**LELAND-JONES**  
**36-7150.18**  
 18 cm/7"



DE BAKEY

**36-4110.19**  
 19 cm/7½"

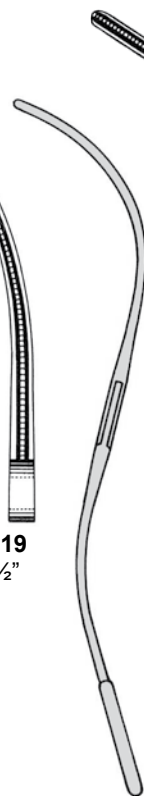

**36-4110.20**  
 20 cm/8"

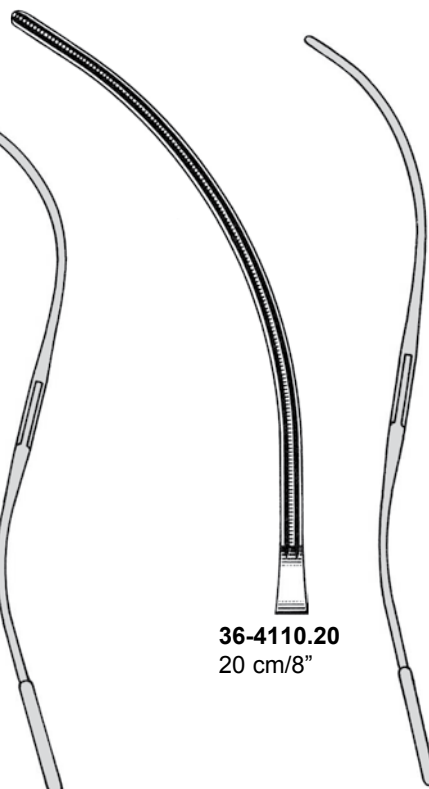

**36-4111.16**  
 16 cm/6¼"

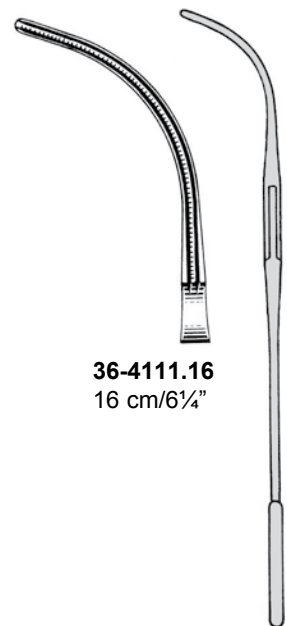

Atraumatische Gefäßklemmen  
 Atraumatic Vascular Clamps  
 Pinces vasculaires atraumatiques  
 Pinzas vasculares atraumáticas  
 Pinze vascolari atraumatiche

**ATRAUMA**



DE BAKEY

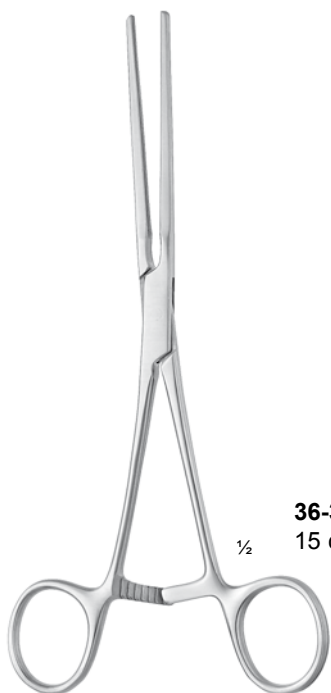

BAINBRIDGE

1/2

**36-3612.15**  
15 cm/6"

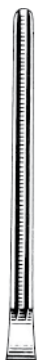

**36-3612.18**  
18 cm/7"



**36-3613.15**  
15 cm/6"



**36-3613.18**  
18 cm/7"



Atraumatische Mehrzweckklemmen  
 Atraumatic Multi-Purpose Clamps  
 Pinces-clamps polyvalentes  
 Pinzas clamps para usos varios  
 Pinze atraumatiche per diversi usi



LELAND-JONES

1/2

**36-0469.20**  
19 cm/7 1/2"

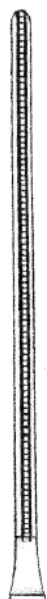

**36-0467.19**  
19 cm/7 1/2"



**36-0467.20**  
20 cm/8"



**ATRAUMA**



DE BAKEY

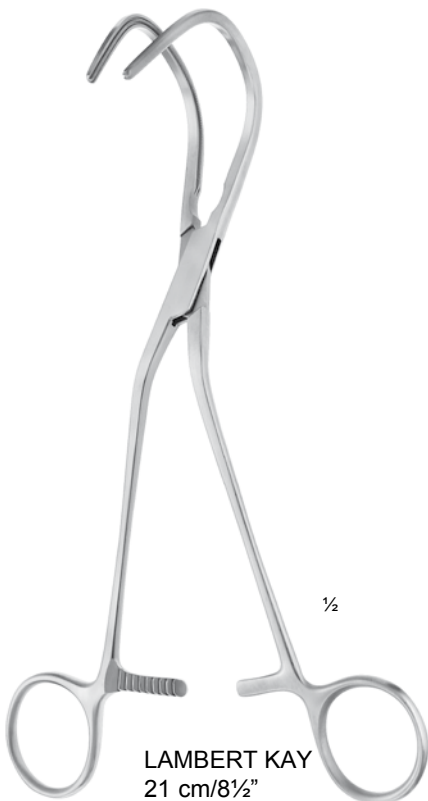

LAMBERT KAY  
21 cm/8½"

Aorta-Anastomosenklemmen  
Aorta-Anastomosis Clamps  
Pincés-clamps pour anastomoses d'aorte  
Pinzas clamps para anastomosis de aorta  
Pinze aortiche

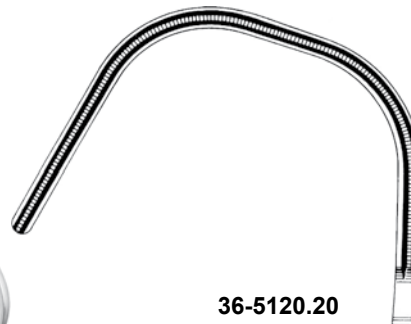

36-5120.20

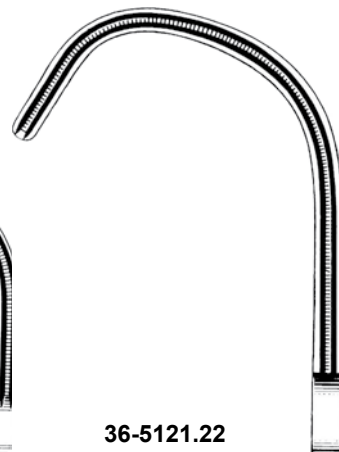

36-5121.22

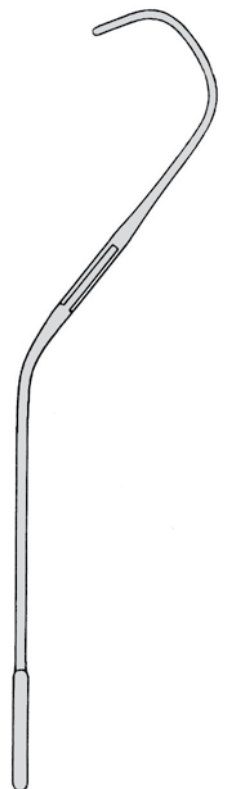

Atraumatische Gefäßklemmen  
Atraumatic Vascular Clamps  
Pincés vasculaires atraumatiques  
Pinzas vasculares atraumáticas  
Pinze vascolari atraumatiche



links gebogen  
curved to left  
courbe à gauche  
curva a la izquierda  
curva a sinistra

WEBER  
**36-5110.01**  
26 cm/10¼"

Aortaklemmen  
Aortic Clamp  
Pince-clamp à aorte  
Pinza clamp para aorta  
Pinza per aorta

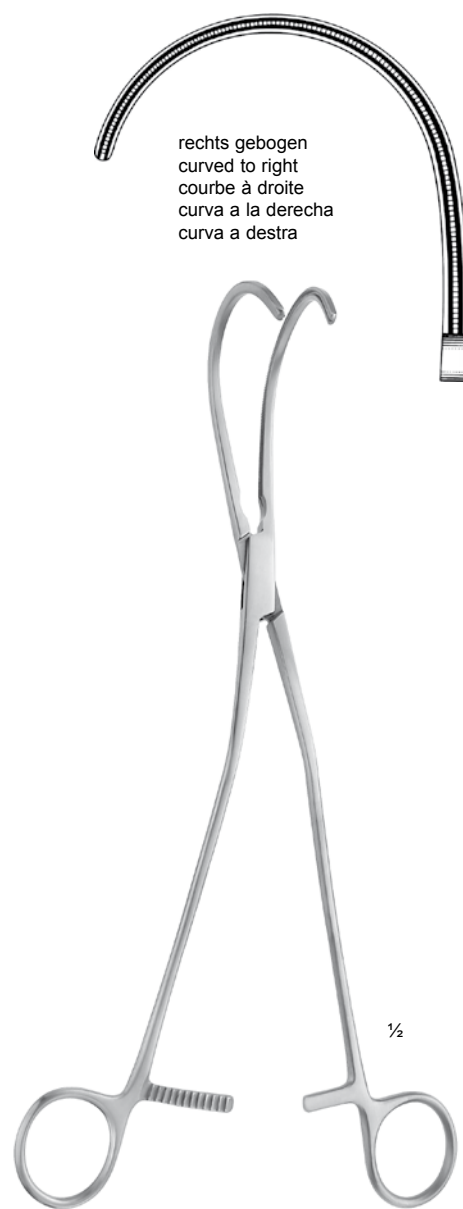

rechts gebogen  
curved to right  
courbe à droite  
curva a la derecha  
curva a destra

WEBER  
**36-5110.02**  
26 cm/10¼"

**ATRAUMA**



DE BAKEY

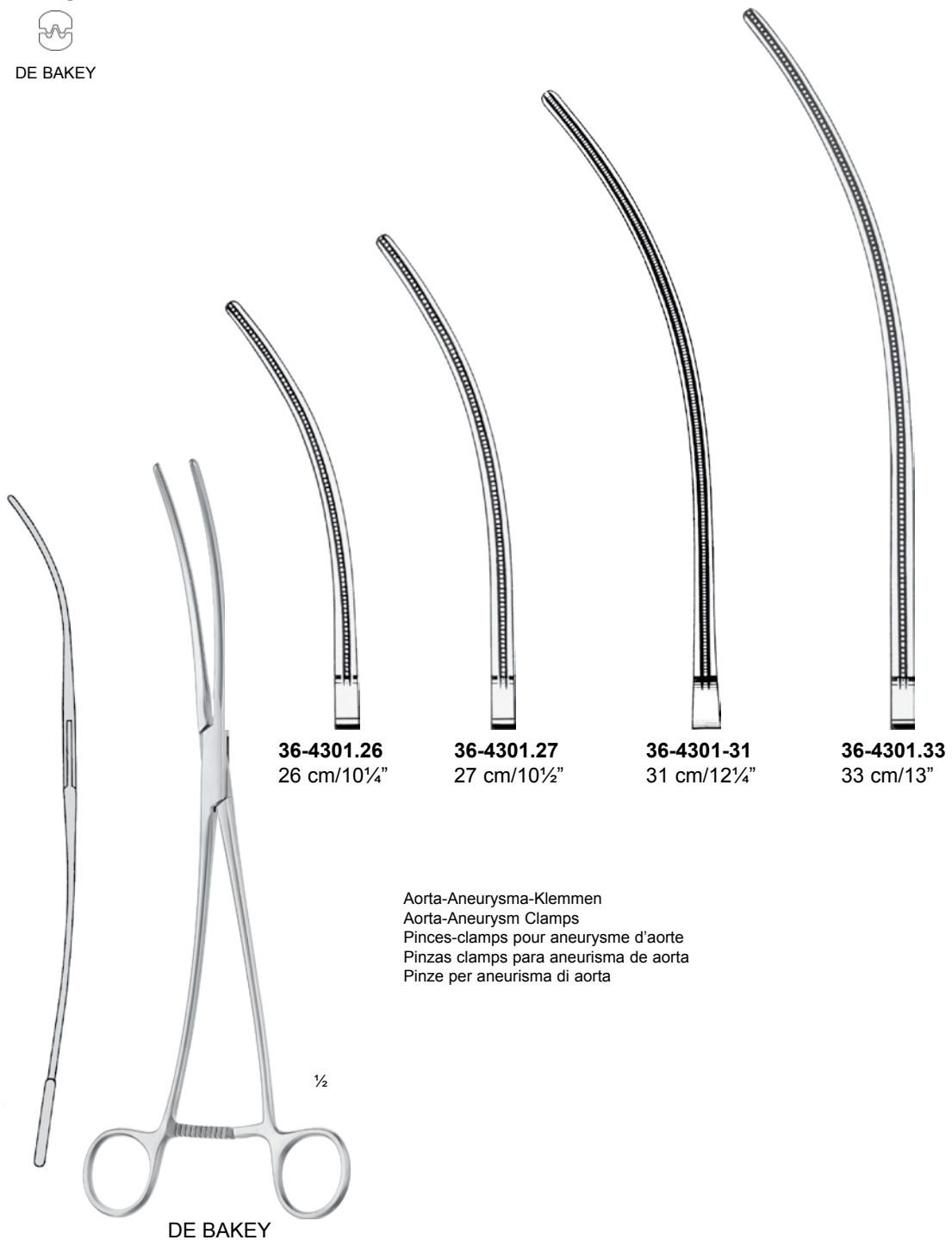

Aorta-Aneurysma-Klemmen  
 Aorta-Aneurysm Clamps  
 Pincés-clamps pour aneurysme d'aorte  
 Pinzas clamps para aneurisma de aorta  
 Pinze per aneurisma di aorta

Atraumatische Gefäßklemmen  
 Atraumatic Vascular Clamps  
 Pinces vasculaires atraumatiques  
 Pinzas vasculares atraumáticas  
 Pinze vascolari atraumatiche



DE BAKEY-BAHNSON

½

**ATRAUMA**



DE BAKEY

**36-6441.23**  
23 cm/9"

**36-6441.24**  
24 cm/9½"

**36-6441.25**  
25 cm/10"

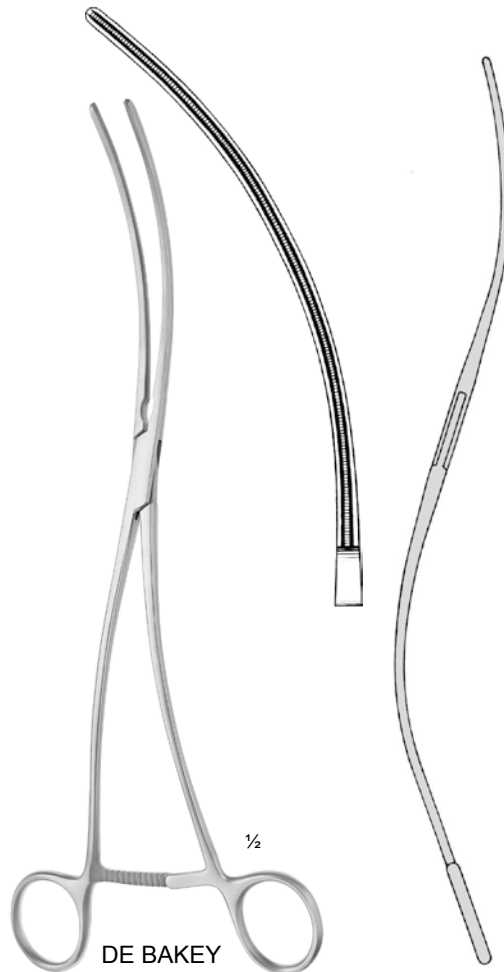

DE BAKEY  
**36-4302.28**  
 30 cm/12"

½



**ATRAUMA**



DE BAKEY

Atraumatische Gefäßklemmen  
 Atraumatic Vascular Clamps  
 Pincés vasculaires atraumatiques  
 Pinzas vasculares atraumáticas  
 Pinze vascolari atraumatiche

Atraumatische Mehrzweckklemmen  
 Atraumatic Multi-Purpose Clamps  
 Pincés-clamps polyvalentes  
 Pinzas clamps para usos varios  
 Pinze atraumatiche per diversi usi

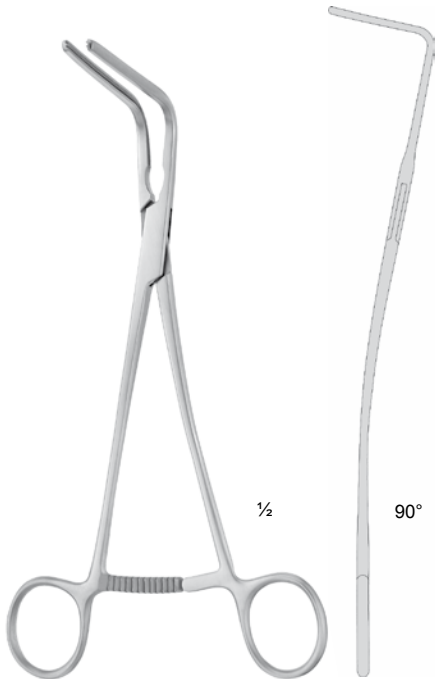

DE BAKEY

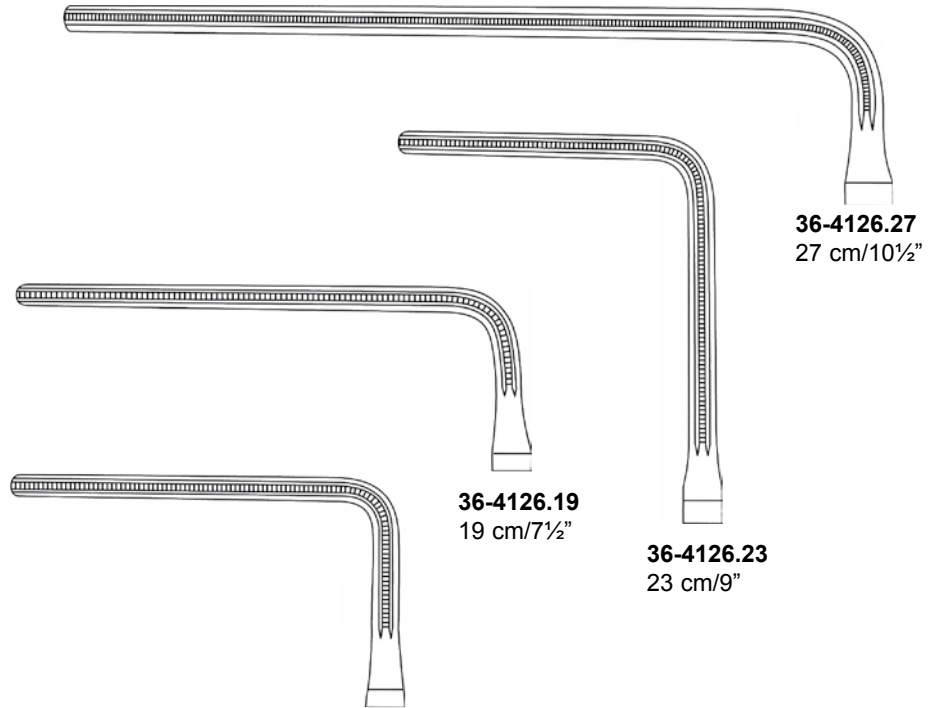

**36-4126.27**  
 27 cm/10½"

**36-4126.19**  
 19 cm/7½"

**36-4126.23**  
 23 cm/9"

**36-4126.18**  
 18 cm/7"

**ATRAUMA**



DE BAKEY

Aorta-Aneurysma-Klemmen  
 Aorta-Aneurysm Clamps  
 Pincés-clamps pour aneurysme d'aorte  
 Pinzas clamps para aneurisma de aorta  
 Pinze per aneurisma di aorta

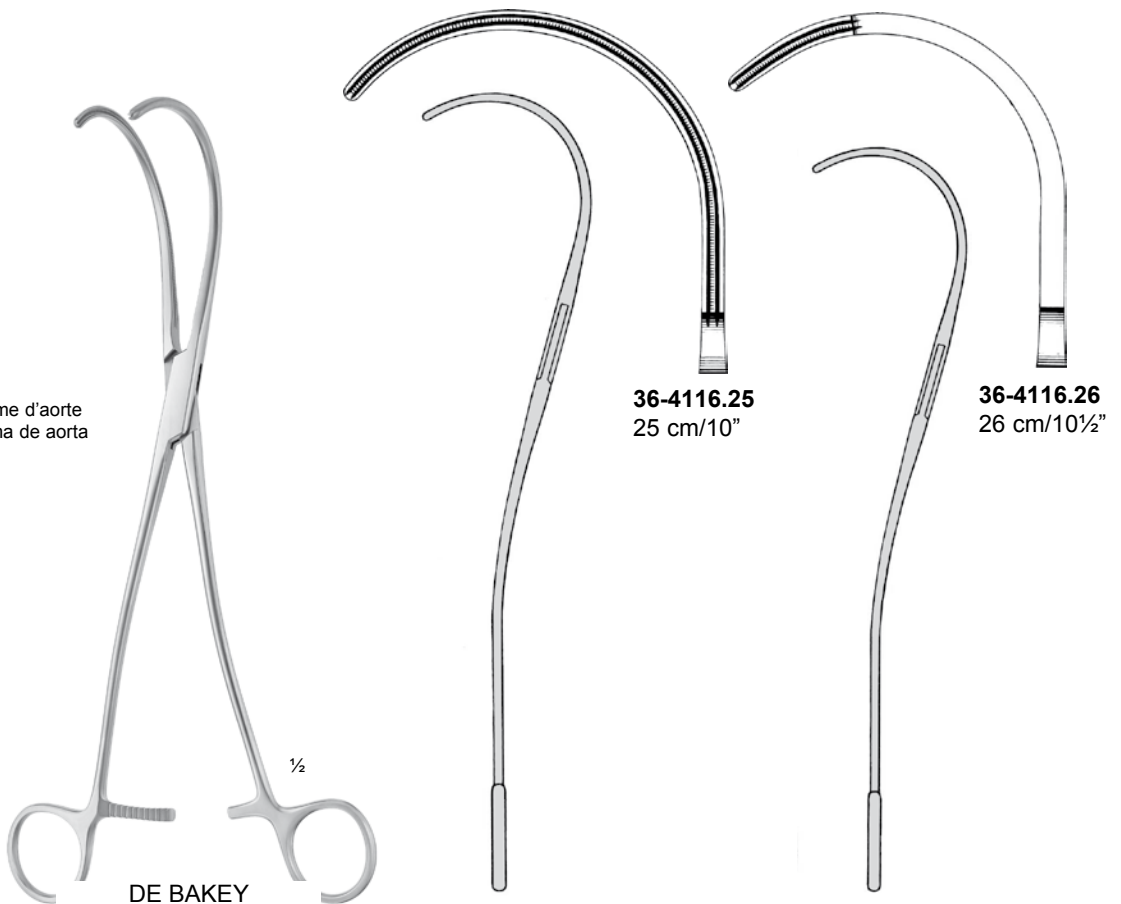

**36-4116.25**  
 25 cm/10"

**36-4116.26**  
 26 cm/10½"

DE BAKEY

Atraumatische Gefäßklemmen  
Atraumatic Vascular Clamps  
Pincés vasculaires atraumatiques  
Pinzas vasculares atraumáticas  
Pinze vascolari atraumatiche

Atraumatische Mehrzweckklemmen  
Atraumatic Multi-Purpose Clamps  
Pincés-clamps polyvalentes  
Pinzas clamps para usos varios  
Pinze atraumatiche per diversi usi

**ATRAUMA**



DE BAKEY



DE BAKEY

60°



**36-4127.20**  
20 cm/8"



**36-4127.21**  
21 cm/8 1/4"

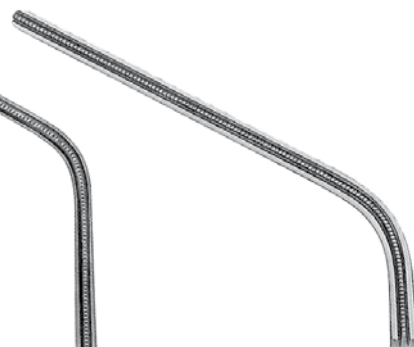

**36-4127.25**  
25 cm/10"

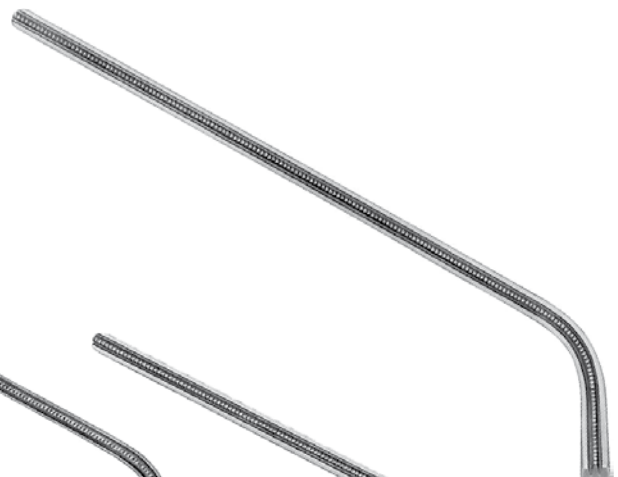

**36-4127.29**  
29 cm/11 3/4"

**ATRAUMA**



DE BAKEY

Tangentalklemmen  
Tangential Occlusion Clamps  
Pinces-clamps pour occlusion tangentielle  
Pinzas para oclusión tangencial  
Pinze per occlusione tangenziale

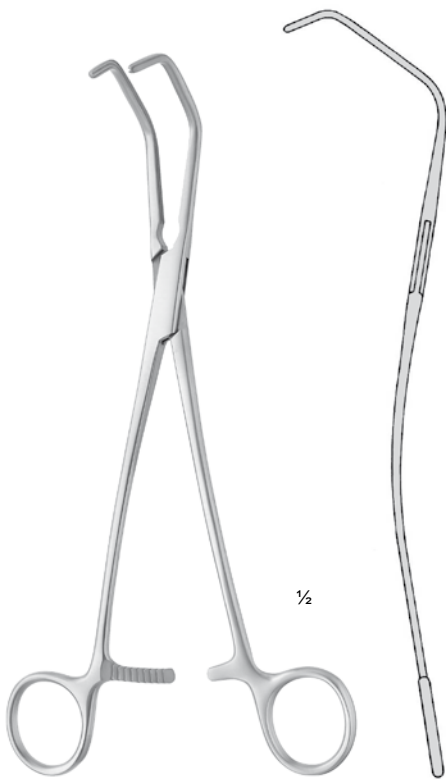

SATINSKY

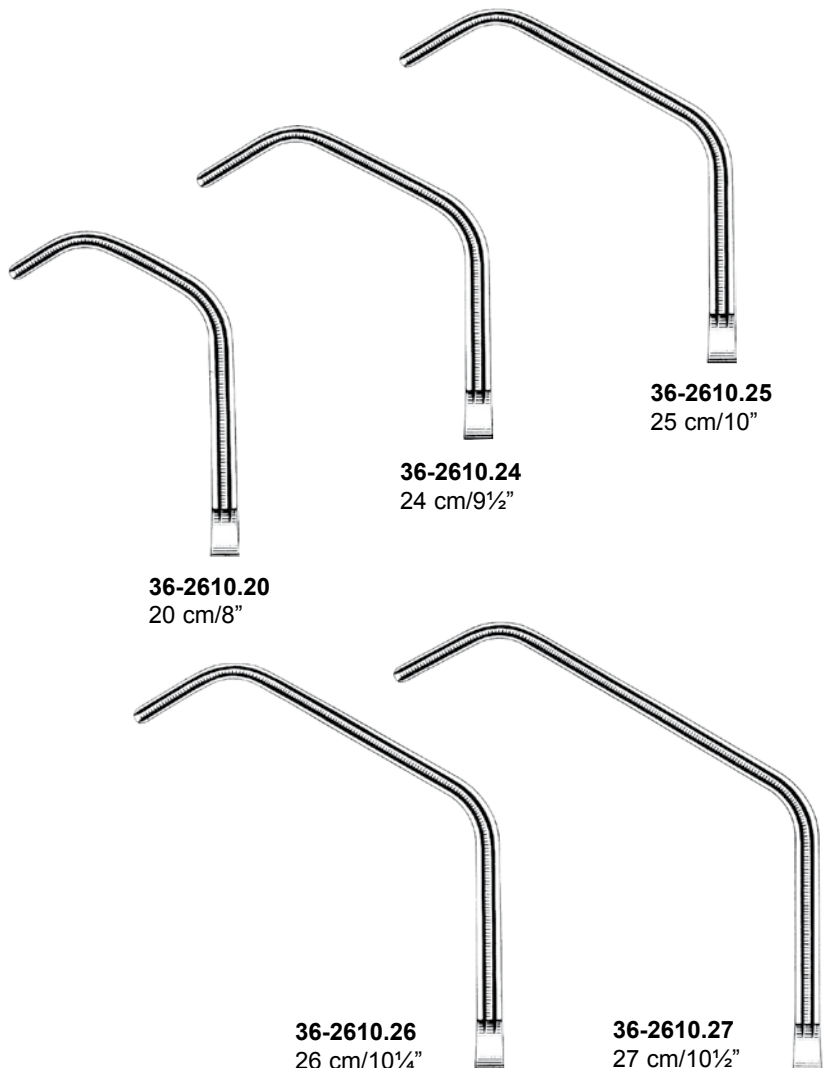

**36-2610.20**  
20 cm/8"

**36-2610.24**  
24 cm/9½"

**36-2610.25**  
25 cm/10"

**36-2610.26**  
26 cm/10¼"

**36-2610.27**  
27 cm/10½"

Atraumatische Gefäßklemmen  
 Atraumatic Vascular Clamps  
 Pinces vasculaires atraumatiques  
 Pinzas vasculares atraumáticas  
 Pinze vascolari atraumatiche

**ATRAUMA**



DE BAKEY

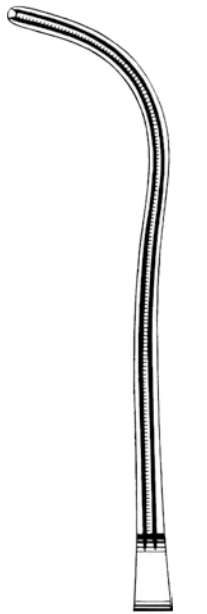

**36-0426-01**

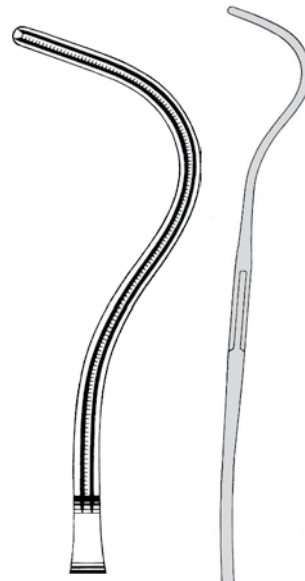

**36-0426-02**

Aurikelklemmen  
 Auricle Clamps  
 Pinces auriculaires  
 Pinzas para auricula  
 Pinze ventricolari

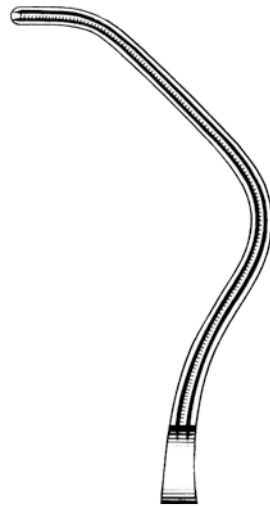

**36-0426-03**

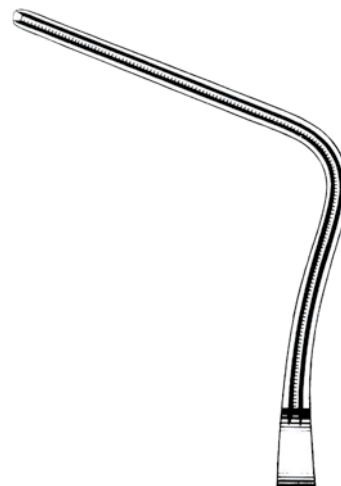

**36-0426-04**



HARKEN  
 24 cm/9½"

½

Atraumatische Gefäßklemmen  
 Atraumatic Vascular Clamps  
 Pincés vasculaires atraumatiques  
 Pinzas vasculares atraumáticas  
 Pinze vascolari atraumatiche

**ATRAUMA**



DE BAKEY

Organfaßzange  
 Organ grasping forceps  
 Pincés pour saisir des organes  
 Pinzas para sacar órganos  
 Pinze per afferrare organi

Peripheal-Gefäßklemmen  
 Peripheal Vascular Clamps  
 Pincés-clamps, vasculaires périphériques  
 Pinzas para vasos periféricos  
 Pinze vascolari periferali



**36-3380.25**  
 25 cm/10"



**36-3380-27**  
 27 cm/10¾"

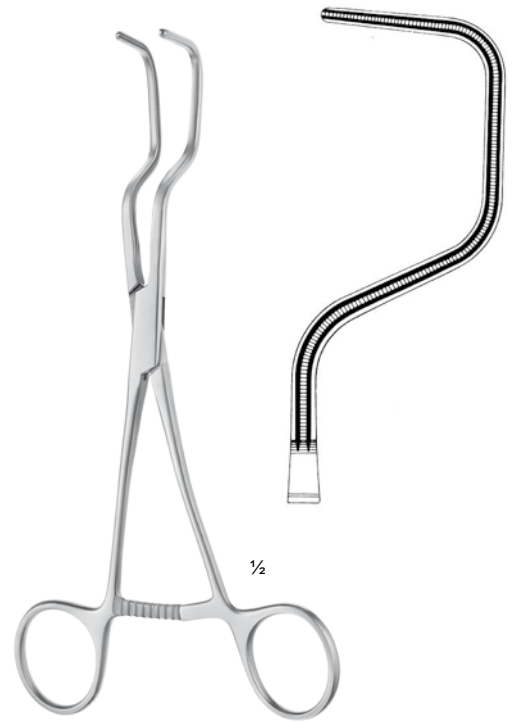

DALE  
**36-4231.18**  
 18 cm/7"



DALE

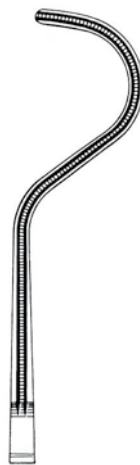

**36-4230.17**  
 17 cm/6½"



**36-4230.18**  
 18 cm/7"

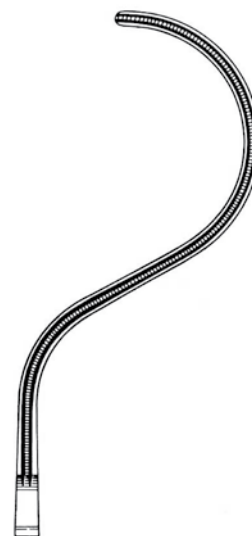

**36-4230.19**  
 19 cm/7¼"

Peripheal-Gefäßklemmen  
 Peripheal Vascular Clamps  
 Pincés-clamps, vasculaires périphériques  
 Pinzas para vasos periféricos  
 Pinze vascolari periferali

Atraumatische Gefäßklemmen  
Atraumatic Vascular Clamps  
Pincés vasculaires atraumatiques  
Pinzas vasculares atraumáticas  
Pinze vascolari atraumatiche

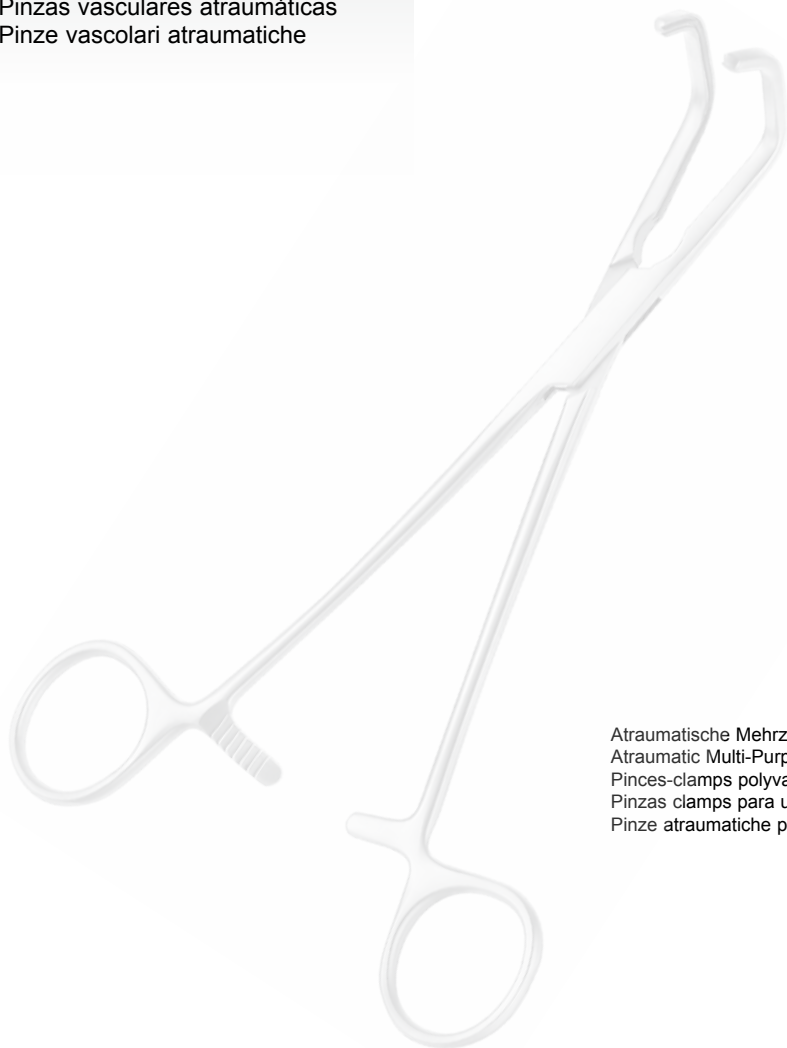

Atraumatische Mehrzweckklemmen  
Atraumatic Multi-Purpose Clamps  
Pincés-clamps polyvalentes  
Pinzas clamps para usos varios  
Pinze atraumatiche per diversi usi

**ATRAUMA**



DE BAKEY



BECK  
36-2622.17  
17 cm/6¾"

½

**ATRAUMA**



DE BAKEY

Präparier- und Ligaturklemmen  
 Dissecting and Ligature Clamps  
 Pincès à dissection et passe-fil  
 Pinzas de disección y para ligaduras  
 Pinze per dissezione e per legature



DE BAKEY  
**36-4219.24**  
 24 cm/9½"



DE BAKEY  
**36-4220.24**  
 24 cm/9½"

Atraumatische Gefäßklemmen  
 Atraumatic Vascular Clamps  
 Pincas vasculaires atraumatiques  
 Pinzas vasculares atraumáticas  
 Pinze vascolari atraumatiche

Coarctationsklemmen  
 Coarction Clamps  
 Pincas à coarctacion  
 Pinzas para coarctación  
 Pinze per coartazione

**ATRAUMA**



DE BAKEY



**36-4124.21**  
21 cm/8¼"



**36-4124.23**  
23 cm/9"



**36-4124.27**  
27 cm/10½"



**36-4124.31**  
31 cm/12¼"

Coarctationsklemmen  
 Coarction Clamps  
 Pincas à coarctacion  
 Pinzas para coarctación  
 Pinze per coartazione



**36-4125.21**  
21 cm/8¼"



**36-4125.23**  
23 cm/9"



**36-4125.27**  
27 cm/10½"



**36-4125.31**  
31 cm/12¼"



**ATRAUMA**



DE BAKEY

Anastomosenklemmen, Kindergrößen  
 Anastomosis Clamps, Pediatric  
 Pincès à anastomose, pédiatriques  
 Pinzas para anastomosis, pediátricas  
 Pinze per anastomosi, pediatriche



DERRA

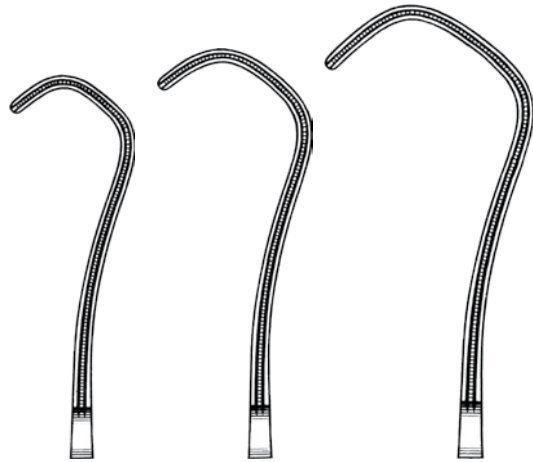

**36-2620.16**  
 16 cm/6¼"

**36-2620.17**  
 17 cm/6¾"

**36-2620.18**  
 18 cm/7"

Coarctationsklemmen  
 Coarction Clamps  
 Pincès à coarctacion  
 Pinzas para coarctación  
 Pinze per coartazione

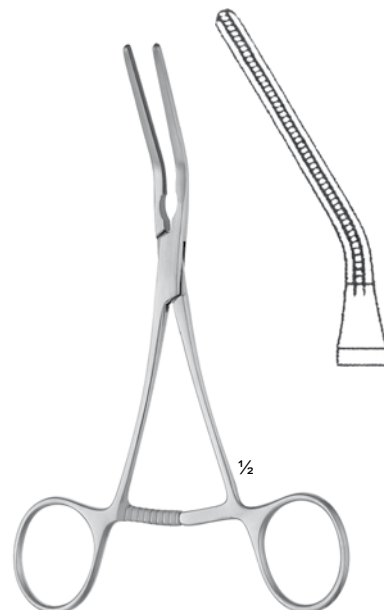

DE BAKEY  
**36-3365.16**  
 16 cm/6¼"

Atraumatische Gefäßklemmen  
Atraumatic Vascular Clamps  
Pincés vasculaires atraumatiques  
Pinzas vasculares atraumáticas  
Pinze vascolari atraumatiche

**ATRAUMA**



DE BAKEY

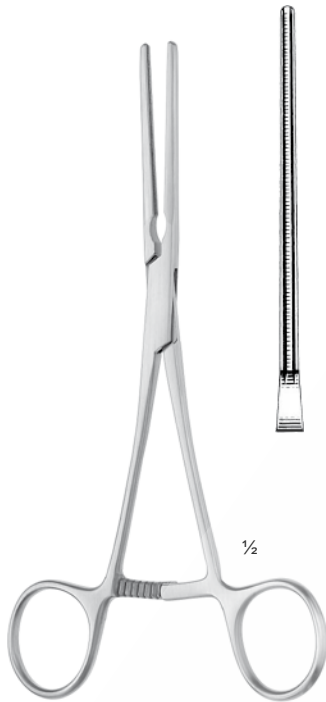

DE BAKEY  
**36-4110.17**  
17 cm/6½"

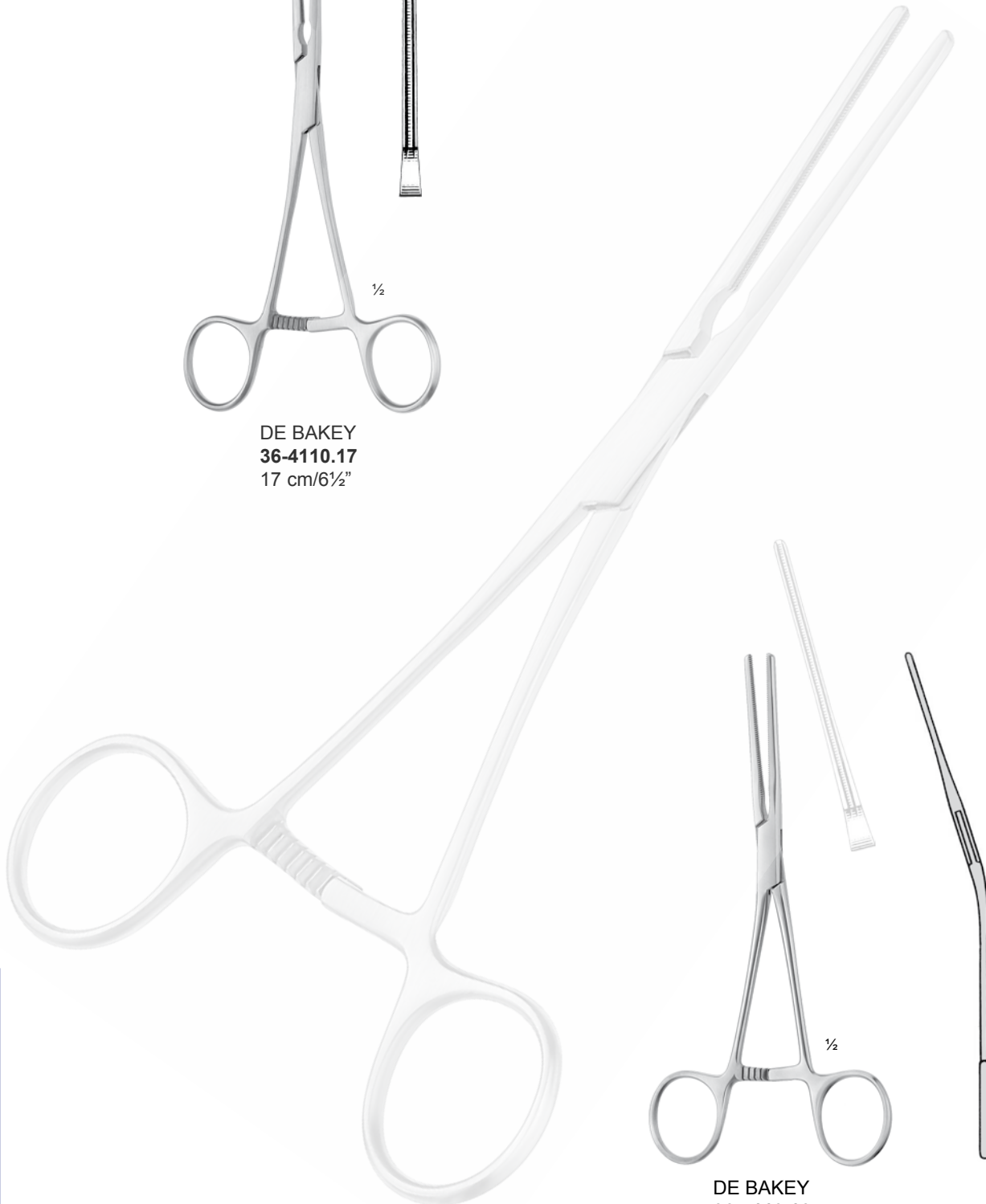

DE BAKEY  
**36-4110.16**  
17 cm/6½"

**ATRAUMA**



DE BAKEY

Coarctationsklemmen  
 Coarction Clamps  
 Pincès à coarctacion  
 Pinzas para coarctación  
 Pinze per coartazione



DE BAKEY

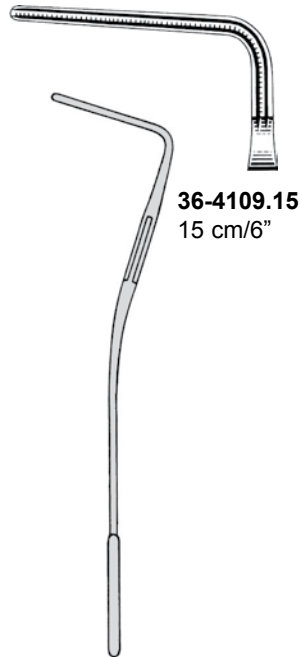

**36-4109.15**  
 15 cm/6"

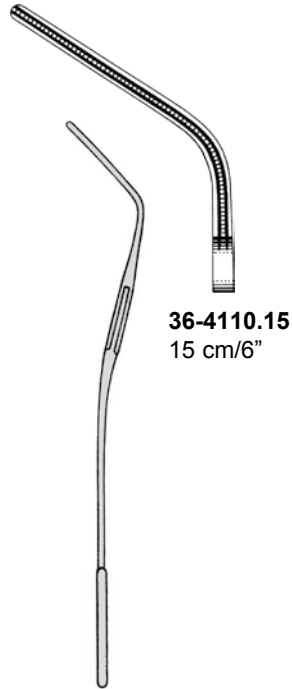

**36-4110.15**  
 15 cm/6"

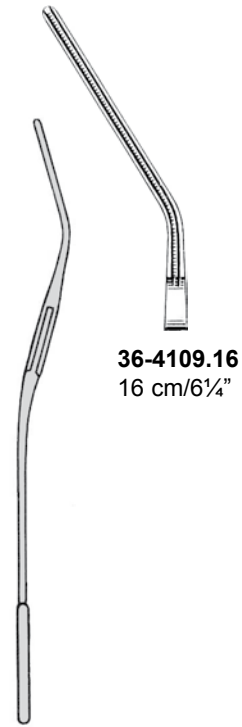

**36-4109.16**  
 16 cm/6¼"



**GLOVER**  
**36-2623.17**  
 17 cm/6¾"



**36-2624.17**  
 17 cm/6¾"

Atraumatische Gefäßklemmen  
Atraumatic Vascular Clamps  
Pincés vasculaires atraumatiques  
Pinzas vasculares atraumáticas  
Pinze vascolari atraumatiche



SUBRAMANIAN-MINIATURE  
**36-3615.15**  
15,5 cm/6"

Aortaklemmen  
Aortic Clamp  
Pince-clamp à aorte  
Pinza clamp para aorta  
Pinza per aorta



**ATRAUMA**



DE BAKEY

Aortaklemmen  
Aortic Clamp  
Pince-clamp à aorte  
Pinza clamp para aorta  
Pinza per aorta



OCHSNER

**36-4221.23**  
23 cm/9"



DIETRICH  
**36-4223.21**  
21 cm/8¼"

Atraumatische Gefäßklemmen  
 Atraumatic Vascular Clamps  
 Pinces vasculaires atraumatiques  
 Pinzas vasculares atraumáticas  
 Pinze vascolari atraumatiche

Ligaturklemmen  
 Ligature Clamps  
 Pinces à passe-fil  
 Pinzas para ligaduras  
 Pinze per legature

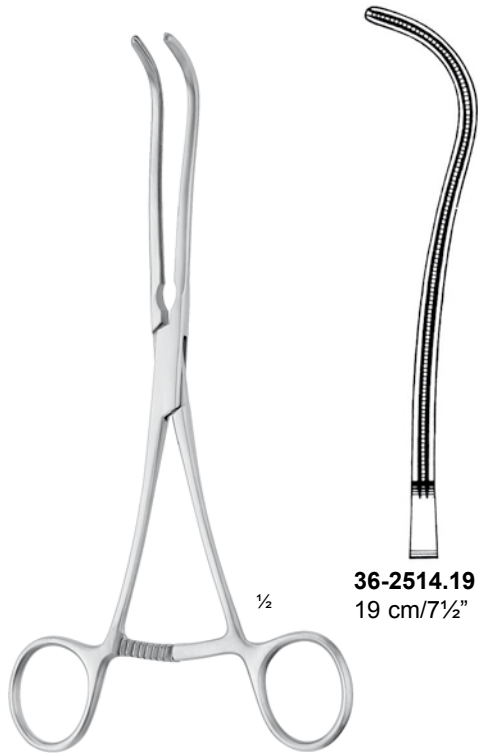

**36-2514.19**  
 19 cm/7½"

DE BAKEY

Anastomosenklemmen  
 Anastomosis Clamps  
 Pinces à anastomose  
 Pinzas para anastomosis  
 Pinze per anastomosi

**ATRAUMA**



DE BAKEY



**DE BAKEY**  
**36-0570.20**  
 20 cm/8"

Carotis-Shuntklemmen  
 Carotid Shunt Clamps  
 Pinces pour carotide  
 Pinzas para shunt carótido  
 Pinze carotis

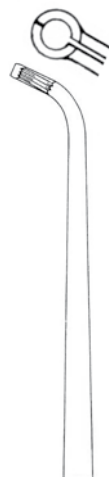

**36-4232.18**  
 19 cm/7½"

JAVID

Präparier- und Ligaturklemmen  
Dissecting and Ligature Clamps  
Pincès à dissection et passe-fil  
Pinzas de disección y para ligaduras  
Pinze per dissezione e per legature

**ATRAUMA**



DE BAKEY



Atraumatische Gefäßklemmen  
 Atraumatic Vascular Clamps  
 Pincés vasculaires atraumatiques  
 Pinzas vasculares atraumáticas  
 Pinze vascolari atraumatiche

**ATRAUMA**



COOLEY

Neonatal- und Kinderklemmen, extra feine Modelle  
 Neonatal and Childrens Clamps, extra delicate patterns  
 Pincés-clamps pour des nouveaux-nés et des enfants, modèles très fins  
 Pinzas clamps para recién nacidos y niños, modelos muy finos  
 Pinze pediatriche, modelli molto fini

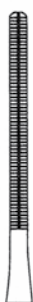

**36-3570.01**  
 14 cm/5½"

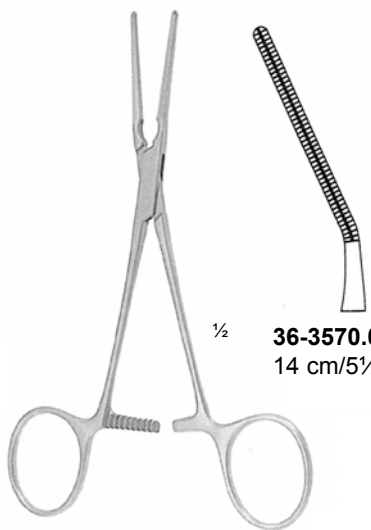

½ **36-3570.02**  
 14 cm/5½"

COOLEY

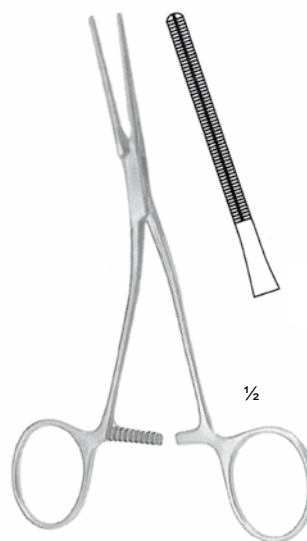

½  
 COOLEY  
**36-3570.03**  
 14 cm/5½"

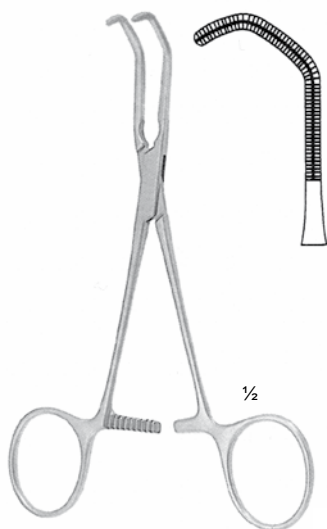

½  
 COOLEY  
**36-3570.04**  
 14 cm/5½"

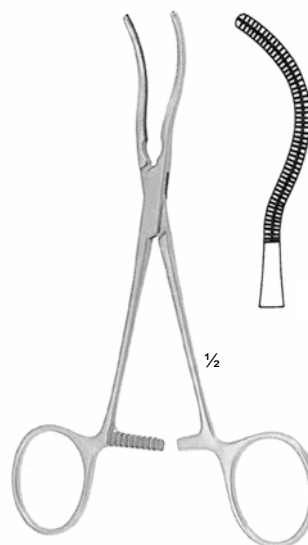

½  
 COOLEY  
**36-3570.05**  
 14 cm/5½"



**ATRAUMA**



COOLEY

Coarctationsklemmen  
 Coarction Clamps  
 Pincès à coarctacion  
 Pinzas para coarctación  
 Pinze per coartazione

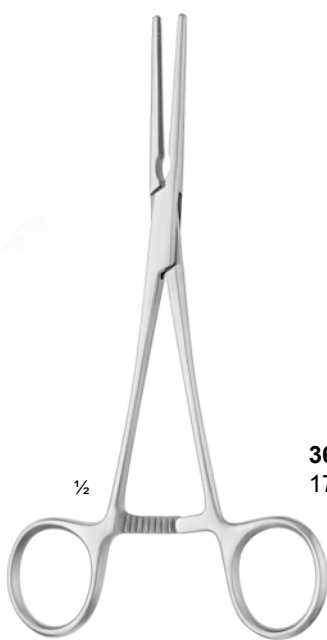

COOLEY

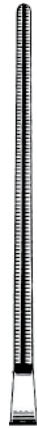

**36-1345.17**  
 17 cm/6<sup>3</sup>/<sub>4</sub>"

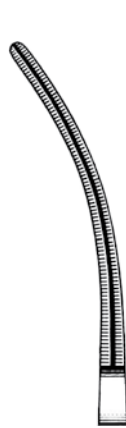

**36-1347.17**  
 17 cm/6<sup>3</sup>/<sub>4</sub>"



**36-1346.17**  
 17 cm/6<sup>3</sup>/<sub>4</sub>"

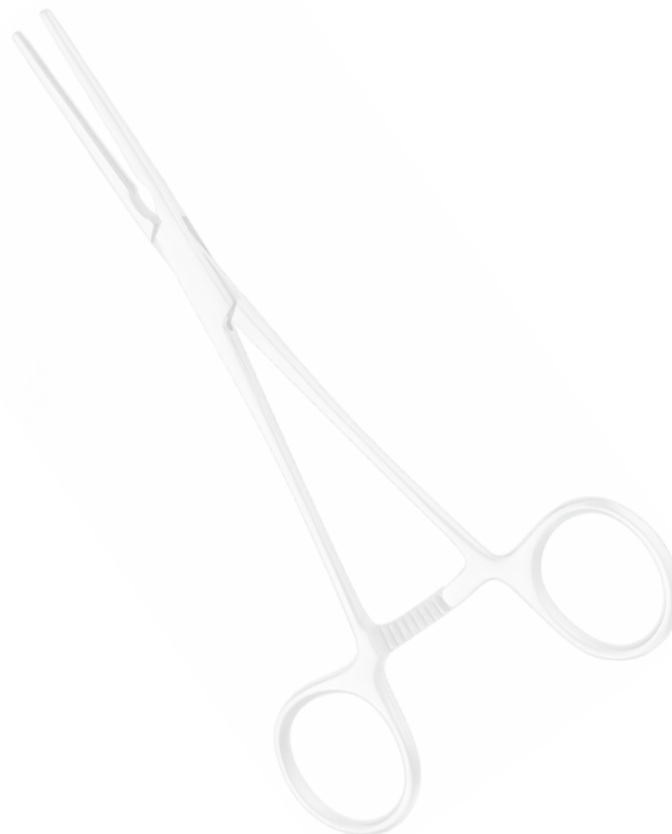

Atraumatische Gefäßklemmen  
Atraumatic Vascular Clamps  
Pincés vasculaires atraumatiques  
Pinzas vasculares atraumáticas  
Pinze vascolari atraumatiche

ATRAUMA



COOLEY

Anastomosenklemmen  
Anastomosis Clamps  
Pincés à anastomose  
Pinzas para anastomosis  
Pinze per anastomosi



COOLEY-BECK  
36-0723.17  
17 cm/6<sup>3</sup>/<sub>4</sub>"

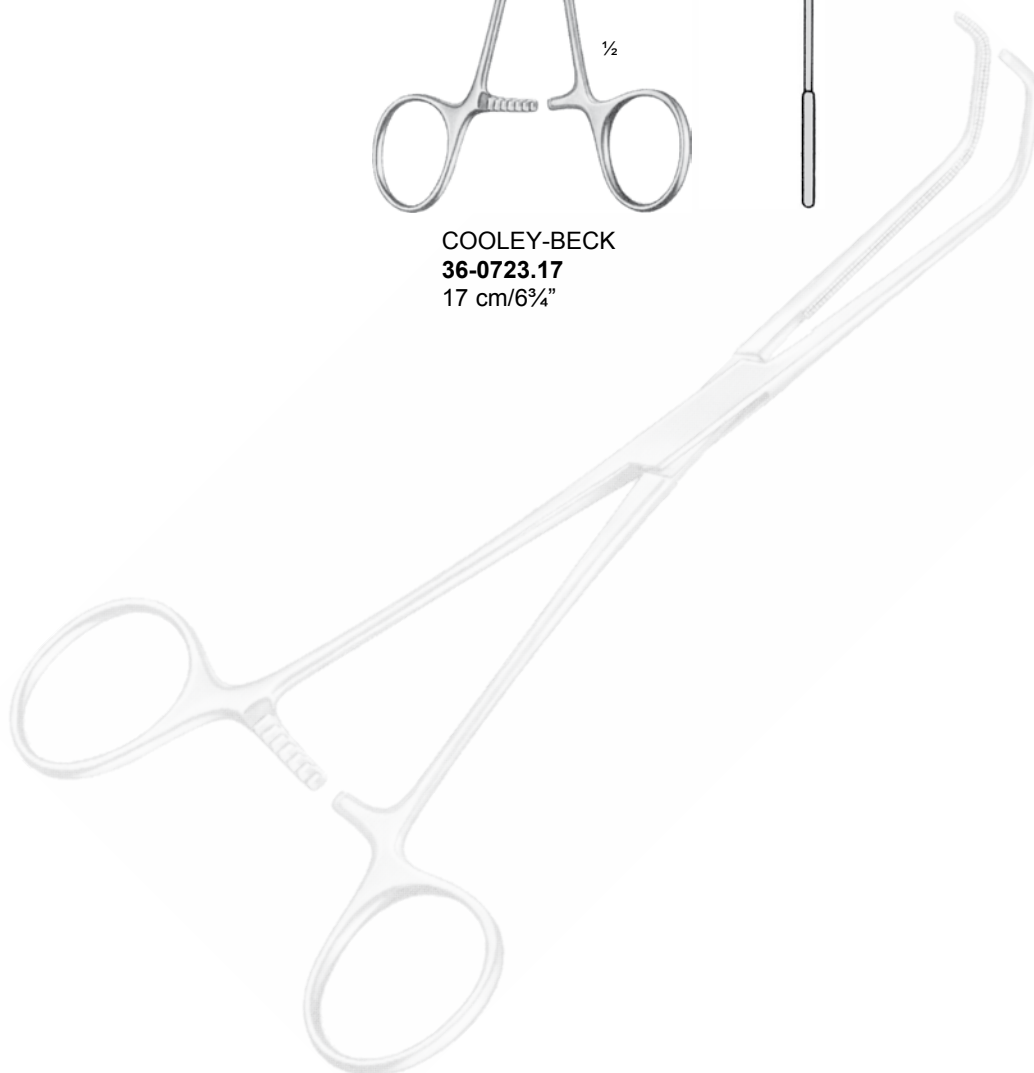

**ATRAUMA**



COOLEY

Atraumatische Mehrzweckklemmen  
 Atraumatic Multi-Purpose Clamps  
 Pincés-clamps polyvalentes  
 Pinzas clamps para usos varios  
 Pinze atraumatiche per diversi usi



COOLEY

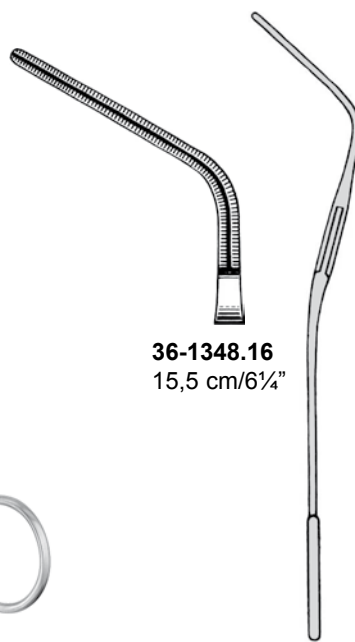

**36-1348.16**  
 15,5 cm/6¼"

Neonatal- und Kinderklemmen  
 Neonatal and Childrens Clamps  
 Pincés-clamps pour des nouveaux-nés et des enfants  
 Pinzas clamps para recién nacidos y niños  
 Pinze pediatriche

Anastomosenklemmen  
 Anastomosis Clamps  
 Pincés à anastomose  
 Pinzas para anastomosis  
 Pinze per anastomosi



COOLEY-DERRA

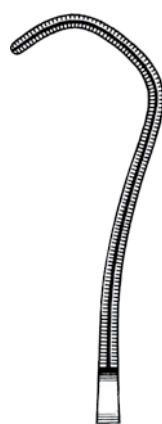

**36-1349.17**  
 17 cm/6¾"

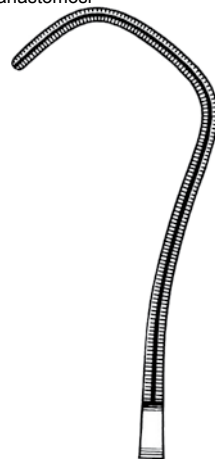

**36-1349.18**  
 18 cm/7"



Atraumatische Gefäßklemmen  
Atraumatic Vascular Clamps  
Pinces vasculaires atraumatiques  
Pinzas vasculares atraumáticas  
Pinze vascolari atraumatiche

Anastomosenklemmen  
Anastomosis Clamps  
Pinces à anastomose  
Pinzas para anastomosis  
Pinze per anastomosi

**ATRAUMA**



COOLEY



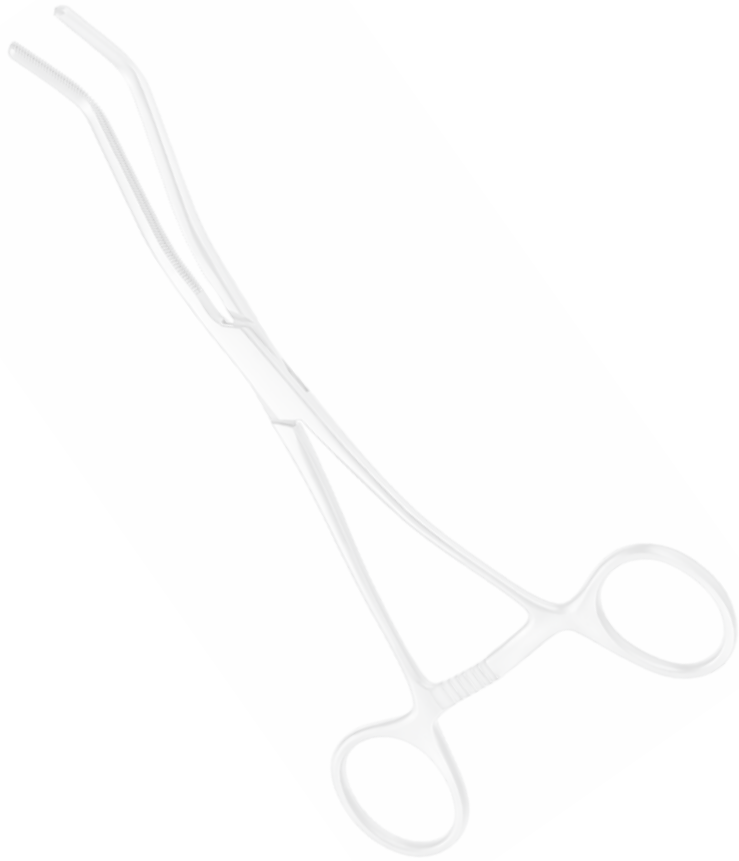

Carotis-Shuntklemmen  
Carotid Shunt Clamps  
Pinces pour carotide  
Pinças para shunt carótido  
Pinze carotis



COOLEY

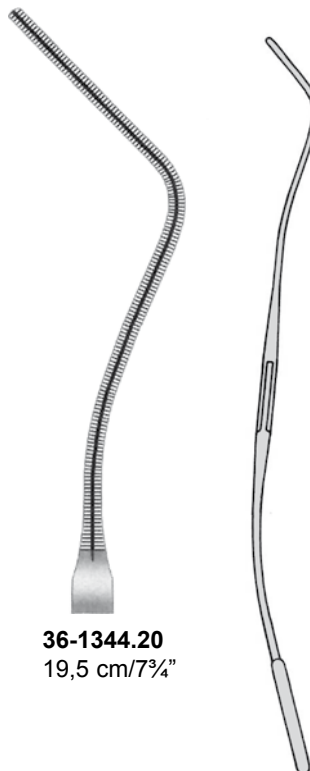

**36-1344.20**  
19,5 cm/7 $\frac{3}{4}$ "

Atraumatische Gefäßklemmen  
 Atraumatic Vascular Clamps  
 Pinces vasculaires atraumatiques  
 Pinzas vasculares atraumáticas  
 Pinze vascolari atraumatiche

Neonatal- und Kinderklemmen, extra feine Modelle  
 Neonatal and Childrens Clamps, extra delicate patterns  
 Pinces-clamps pour des nouveaux-nés et des enfants, modèles très fins  
 Pinzas clamps para recién nacidos y niños, modelos muy finos  
 Pinze pediatriche, modelli molto fini

**ATRAUMA**



COOLEY

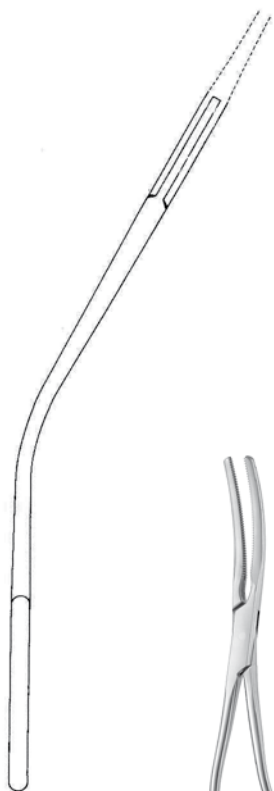

COOLEY

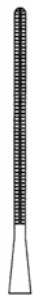

**36-3364.01**  
 14 cm/5½"



**36-3364.02**  
 14 cm/5½"



**36-3364.03**  
 14 cm/5½"



**36-3364.04**  
 13 cm/5"



**36-3364.05**  
 14 cm/5½"



**36-3364.06**  
 13 cm/5"



**36-3364.08**  
 13 cm/5"



**36-3364.08**  
 14 cm/5½"

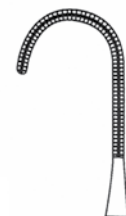

**36-3364.09**  
 13,5 cm/5¼"

**ATRAUMA**



COOLEY

Neonatal- und Kinderklemmen, extra feine Modelle  
Neonatal and Childrens Clamps, extra delicate patterns  
Pincés-clamps pour des nouveaux-nés et des enfants, modèles très fins  
Pinzas clamps para recién nacidos y niños, modelos muy finos  
Pinze pediatriche, modelli molto fini



1/2



**36-3366.16**  
15,5 cm/6 1/8"

COOLEY

Atraumatische Gefäßklemmen  
 Atraumatic Vascular Clamps  
 Pincas vasculaires atraumatiques  
 Pinzas vasculares atraumáticas  
 Pinze vascolari atraumatiche

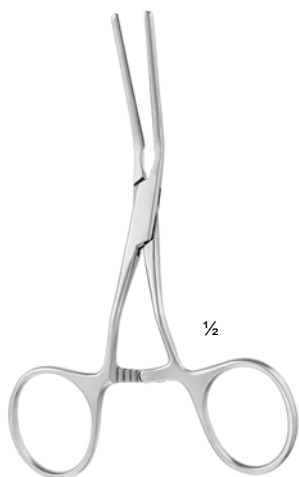

**CASTAÑEDA**  
 13 cm/5"

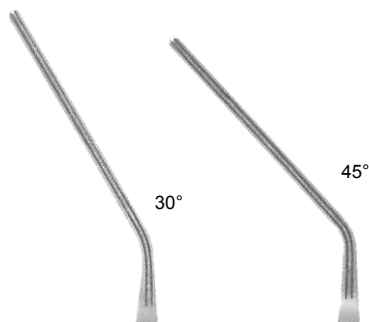

**36-3367.13**

**36-3368.13**

Neonatal- und Kinderklemmen, extra feine Modelle  
 Neonatal and Childrens Clamps, extra delicate patterns  
 Pincas-clamps pour des nouveaux-nés et des enfants, modèles très fins  
 Pinzas clamps para recién nacidos y niños, modelos muy finos  
 Pinze pediatriche, modelli molto fini

**ATRAUMA**



DE BAKEY



**CASTAÑEDA**  
 12 cm/4<sup>3</sup>/<sub>4</sub>"



**36-3368.12**

**36-3369.12**

**36-3370.12**

14 cm/4<sup>3</sup>/<sub>4</sub>"

Neonatal- und Kinderklemmen, extra feine Modelle  
 Neonatal and Childrens Clamps, extra delicate patterns  
 Pincas-clamps pour des nouveaux-nés et des enfants, modèles très fins  
 Pinzas clamps para recién nacidos y niños, modelos muy finos  
 Pinze pediatriche, modelli molto fini

**ATRAUMA**



DE BAKEY



**ATRAUMA**



CASTAÑEDA

Neonatal- und Kinderklemmen, extra feine Modelle  
 Neonatal and Childrens Clamps, extra delicate patterns  
 Pincès-clamps pour des nouveaux-nés et des enfants, modèles très fins  
 Pinzas clamps para recién nacidos y niños, modelos muy finos  
 Pinze pediatriche, modelli molto fini



**36-3367.13**  
 12,5 cm/5"

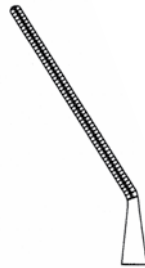

**36-3368.13**  
 11,5 cm/4½"

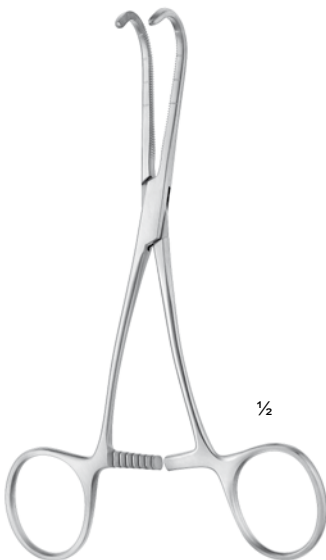

CASTAÑEDA

½



**36-3368.12**  
 11,5 cm/4½"



**36-3369.12**  
 12 cm/4¾"



**36-3370.12**  
 12 cm/4¾"





# ROLAN

Instruments GmbH

ROLAN Instruments GmbH  
Ernst-Thälmann-Str. 50  
15859 Storkow / Germany

Tel: 0049 33678 44 94 33  
[info@rolan-instruments.de](mailto:info@rolan-instruments.de)  
[www.rolan-instruments.de](http://www.rolan-instruments.de)